



P/N : MMBB0110907

Revision 1.2
PRINTED IN KOREA

USER'S MANUAL

MODEL: W1500



ENGLISH

CE 0700



WAP Phone

USER'S MANUAL

MODEL: G1500

Please read this manual carefully
before operating your set.
Retain it for future reference.



WAP Phone

USER'S MANUAL

MODEL : G1500

Please read this manual carefully
before operating your set.
Retain it for future reference.

G1500 has a polished style which provides users' a better feel and convenience.



G1500 Phone

For Your Safety

All radio transmitters carry risks of interference with electronics in close proximity.



GSM Phones must be switched off at all times in an aircraft.



Do not activate near petrol stations, fuel depots, chemical plants or blasting operations.



Switch off the phone in any area where are forced by special regulations. For example, the phone does not allow to be used in hospital because pacemakers and hearing aids can be affected.



Minor interference may affect TVs, radios, PCs, etc.



Do not hold the phone in your hand while driving.



Do not dismantle phone or battery.



Keep the phone in a safe place out of children's reach since it contains the detachable small parts and create a choking hazard.



Do not touch the charger with wet hands.



For your safety, use **ONLY** specified **ORIGINAL** batteries and chargers.

Please note:



Unusable batteries should be disposed of in accordance with relevant legislation.



Only use **ORIGINAL** accessories to avoid damage to your phone.



Emergency call may not be available under all cellular networks. Therefore, you should never depend solely on the phone for essential communications such as medical emergencies.

Important Information

This user's guide contains important information on the use and operation of this phone. Please read all the information carefully for optimal performance and to prevent any damage to or misuse of the phone. Any changes or modifications not expressly approved in this user's guide could void your warranty for this equipment.

Contents

Overview

Part of the Phone 10

- Front of the Phone 10
- Rear of the Phone 11

Key Description 12

- Alphanumeric Keys 13

Display Information

Display Information 14

- On-Screen Icons 14

Getting Started

Installation 16

- Inserting the SIM Card 16
- Installing the Battery 16
- Charging the Battery 17
- Disconnecting the charger 18

Powering On Sequence 19

- To get started with the phone 19
- To turn off the phone 19

Access Codes 20

- PIN code (4 to 8 digits) 20
- PIN2 code (4 to 8 digits) 20
- PUK code (4 to 8 digits) 20
- PUK2 code (4 to 8 digits) 20
- Security code (4 to 8 digits) 20

Accessing the Menu

Phone book	21
• Search [Names 1]	22
• Add new [Names 2]	23
• Speed dial [Names 3]	24
• Voice list [Names 4]	25
• Caller groups [Names 5]	25
• Copy all [Names 6]	26
• Delete all [Names 7]	27
• Settings [Names 8]	27
• Information [Names 9]	28
Menu Tree	29
Messages [Menu 1]	31
• Write message [Menu 1-1]	31
• Inbox [Menu 1-2]	35
• Outbox [Menu 1-3]	36
• Info service [Menu 1-4]	37
• Voice messages [Menu 1-5]	38
• Namecard [Menu 1-6]	39
• Templates [Menu 1-7]	39
• Settings [Menu 1-8]	40
• Check memory [Menu 1-9]	40
Call Register [Menu 2]	41
• Missed calls [Menu 2-1]	41
• Received calls [Menu 2-2]	41
• Dialed calls [Menu 2-3]	41
• Clear recent calls [Menu 2-4]	41
• Call charge [Menu 2-5]	42

Profiles [Menu 3]	45
• Vibrate only [Menu 3-1]	45
• Quiet [Menu 3-2]	45
• General [Menu 3-3]	45
• Loud [Menu 3-4]	46
• Headset [Menu 3-5]	46
Settings [Menu 4]	48
• Alarm clock [Menu 4-1]	48
• Date & Time [Menu 4-2]	49
• Phone settings [Menu 4-3]	50
• Call settings [Menu 4-4]	51
• Security settings [Menu 4-5]	54
• Network settings [Menu 4-6]	57
• Restore factory settings [Menu 4-7]	57
Call Divert [Menu 5]	58
• All voice calls [Menu 5-1]	58
• If busy [Menu 5-2]	58
• If no reply [Menu 5-3]	58
• If unreachable [Menu 5-4]	58
• All data calls [Menu 5-5]	58
• All fax calls [Menu 5-6]	58
• Cancel all [Menu 5-7]	59
Scheduler [Menu 6]	60
• Add new [Menu 6-1]	60
• View day [Menu 6-2]	61
• View all [Menu 6-3]	61
• Delete passed [Menu 6-4]	61
• Delete all [Menu 6-5]	61

Fun & Tools [Menu 7]	62
• Game [Menu 7-1]	62
• Unit convert [Menu 7-2].....	62
• Calculator [Menu 7-3].....	63
• World time [Menu 7-4].....	63
Internet [Menu 8]	64
• Home [Menu 8-1]	64
• Bookmarks [Menu 8-2]	64
• Profiles [Menu 8-3]	64
• Go to URL [Menu 8-4]	67
• Cache settings [Menu 8-5]	67
• Security certifications [Menu 8-6].....	67
• Reset profiles [Menu 8-7]	67
Internet On-line menu	68
<u>Additional Functions</u>	
How to Use Data and Fax call	69
• Sending Data or Fax Calls	69
• Receiving Data or Fax Calls	69
In call Menu	71
• During a call	71
• Multiparty or Conference Calls	73
Accessories	75
Care and Maintenance	76
Technical Data	78

Front of the Phone

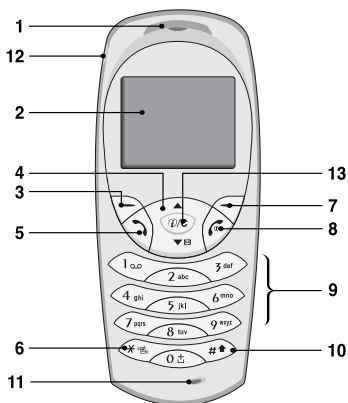

- | | |
|--------------------------|------------------------------------|
| 1 Earpiece | 8 END/PWR keys |
| 2 Display Screen | 9 Numeric Keys |
| 3 Soft Left Key | 10 Hash Key |
| 4 Navigation Keys | 11 Microphone |
| 5 Send Key | 12 Ear Microphone Connector |
| 6 Star Key | 13 Cancel Key |
| 7 Soft Right Key | |



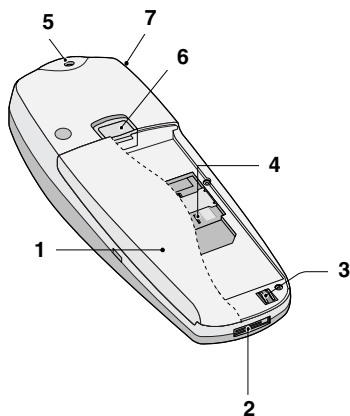









Rear of the Phone



- 1 Battery**
- 2 Cable Connector/
Battery Charging Connector**
- 3 Battery Terminals**
- 4 SIM Card Socket**
- 5 Handstrap Hole**
- 6 Battery Lock**
- 7 Ear Microphone Connector**

The following shows key components of the phone.











Keypad Description

Key	Description
	<p>Soft Left Key / Soft Right Key Each of these keys performs the function indicated by the text on the display immediately above it.</p>
	<p>WAP Hotkey Used to connect to WAP directly by pressing this key. Used to delete character(s).</p> <p>Navigation Keys Used to scroll through name, phone numbers, menus or setting options.</p>
	Used to enter Message menu directly.
	Used to scroll through names, phone numbers.
	<p>Send Key You can dial a phone number and answer a call. If you press this key without entering a number, your phone shows the most recently dialed number.</p>
	<p>Numeric Keys These keys are used mainly to dial in standby mode and enter numbers or characters in editing mode. When you press these keys for a long time.</p> <ul style="list-style-type: none"> Used to call your voicemail box by . Used to call for international call by . Used to call Speed dials by from  to .
	Used to enter the vibration mode by pressing this key for a long time
	Used to call by voice dial with long pressing this key. This key is also used as Ear mic. hook key when connecting Ear mic.

Key	Description
	END/PWR Key Used to end or reject a call. This key is also used as Power Key. Pressing and holding this key for a few seconds.















Alphanumeric Keys

The alphabet and numerical keypad mapping relation are listed as the following table.









Key	Description
	., / ? ! - : ' " 1
	A B C 2 Ä Å Ã Ä Å Æ Ç a b c ä å á â ã ä æ ç
	D E F 3 Ě Ě Ě Ě Ě d e f ě ě ě ě ě
	G H I 4 Ĩ Ĩ Ĩ Ĩ Ĩ Ğ g h i ĩ ĩ ĩ ĩ ğ
	J K L 5 j k l
	M N O 6 Ñ Ö Õ Ó Ô Õ Œ m n o ñ ö ò ó ô õ œ
	P Q R S 7 ß Ş p q r s ß ş
	T U V 8 Ü Û Ú Û t u v ü ù ú û
	W X Y Z 9 w x y z
	[Space Key] 0

The screen displays several icons the following describe each of them you may see on the phone.

On-Screen Icons

Icon/Indicator	Description
	Tells you the strength of the network signal.
	Call is connected.
	Line 1/2 is in use for outgoing calls – If you subscribe to the Two Line Service.
	The alarm has been set and is on.
	Tells you the status of the battery.
	You have received a text message.
	You have received a voice message depending on your subscription.
	You have received an E-mail.
	You can view your schedule.
	All audible signals are turned off.
	General menu in profiles.
	Loud menu in profiles.
	Quiet menu in profiles.
	Headset menu in profiles.
	You can divert a call.

Top Menu Icons

Icon	Description
	Messages
	Call Register
	Profiles
	Settings
	Call Divert
	Scheduler
	Fun & Tools
	Internet
	Sim service

1 Inserting the SIM Card

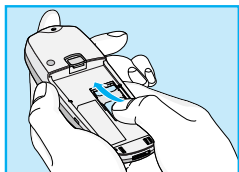

Locate the SIM card socket in the back of the phone.
Follow the steps below to install the SIM card.

1. Remove the battery if attached.
2. Slide the SIM card into the slot, under the silvery holders, with the golden connectors facing down and the cut corner to the right.

! Notice

- Before installing always make sure that the phone is switched off and remove the battery.
- The metal contact of the SIM card can be easily damaged by scratches. Pay special attention to the SIM card when you handle and install. Follow the instructions supplied with the SIM card.

2 Installing the Battery

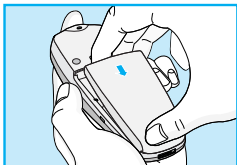

1. Place the battery on the back of the phone.

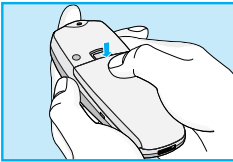

2. Push it until you hear a click.

3 Charging the Battery

To connect the travel adapter to the phone, you must have installed the battery.

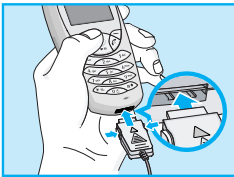

1. Insert one end of the travel adapter into the bottom of the phone.

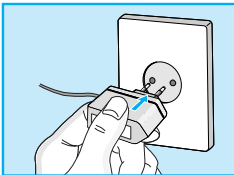

2. Connect the other end of the travel adapter to an AC wall outlet.
Use only the included packing charger.



! Warning

- Do not force the connector as this may damage the phone and/or the travel adapter.

4 Disconnecting the charger

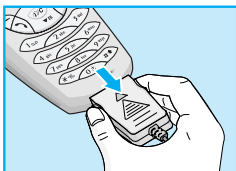



Disconnect the travel adapter from the phone by pressing its side buttons.

! Notice

- The battery delivered with your phone has to be fully charged before using it.
- Do not remove your battery or the SIM card while charging.
- “Charging” is displayed on the screen after connecting the travel adapter. Only if the battery is totally empty, Back light is on without displaying “Charging”.
- The moving bars of battery icon will stop after charging completely.

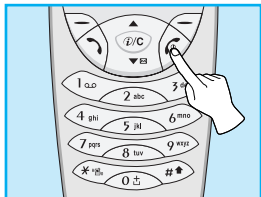
1 To get started with the phone



1. Press and hold  key until you hear a tone.
2. Depending on setting **PIN Code** [Menu 4-5-1], you can enter PIN code or not.
3. If your phone connects to a network, the network name will be displayed shortly.

2 To turn off the phone

In stand by mode, press and hold  key until you hear a tone.

You can use the access codes described in this section to avoid unauthorized use of your phone. The access codes (except PUK and PUK2 codes) can be changed by using [Menu 4-5-6].

[PIN code \(4 to 8 digits\)](#)

The PIN (Personal Identification Number) code protects your SIM card against unauthorized use. The PIN code is usually supplied with the SIM card. When **PIN code** is set **Enable**, your phone will request the PIN code every time it is switched on. On the contrary, when **PIN code** is set **Disable**, your phone connects to the network directly without the request PIN code.

[PIN2 code \(4 to 8 digits\)](#)

The PIN2 code, supplied with some SIM cards, is required to access some functions such as Advice of call charge, Fixed Dial number. These functions are only available if supported by your SIM card.

[PUK code \(4 to 8 digits\)](#)

The PUK(Personal Unblocking Key) code is required to change a blocked PIN code. The PUK code may be supplied with the SIM card. If not, contact your local service provider for the code. If you lose the code, also contact your service provider.

[PUK2 code \(4 to 8 digits\)](#)

The PUK2 code, supplied with some SIM cards, is required to change a blocked PIN2 code. If you lose the code, also contact your service provider.

[Security code \(4 to 8 digits\)](#)



The security code protects the unauthorized use of your phone. It is usually supplied with the phone. This code is required to delete all phone entries and to activate "Restore factory settings" menu. The default number of Security code is "0000". You can also change it in Security menu.

Phone book

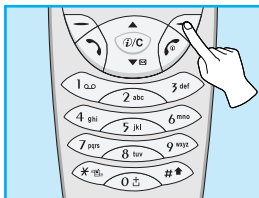
Accessing the Menu









To select a menu in phonebook, press  [Names] in standby mode and then scroll to a desired item.

	Name	Description
1	Search	Allows you to search for a specific name, number.
2	Add new	Allows you to add new names and numbers.
3	Speed dial	Allows you to assign up to 8 ( - ) one-touch dial allocations.
4	Voice list	Allows you to list phone numbers which is attached voice.
5	Caller groups	Allows you to show group list.
6	Copy all	Allows you to copy entries from your Phone memory to SIM card or from SIM card to Phone memory.
7	Delete all	Allows you to erase all the data in either your phonebook or the SIM card to the phone memory.
8	Settings	Allows you to set the memory and to search item by variable, name and number.
9	Information	Allows you to check the status of memory, SDN (Service Dial Number), and Own number.

Search [Names 1]

(Calling from phonebook)









1. Open the phonebook first by pressing  [Names] in a standby mode.
2. **Search** by Pressing  [Select] to enter.
3. Depending on setting **Search by**, the below menu may not appear.
 - **Name**
 - **Number**
4. You can find an entry by name and number.
5. Select  [Search].
6. You can check the names and numbers by pressing  [List].
7. If you want to edit, delete, copy an entry, or to add the voice to one, select  [Options]. The below menu will be displayed.
 - **Edit** : You can edit the name, number, E-mail, and fax by pressing  [OK].
 - **Delete** : You can delete an entry.
 - **Copy** : You can copy a entry from SIM to phone or from phone to SIM.
 - **Call** : You can call thru the chosen entry.
 - **Voice** : You can add the voice to the entry or change the voice tag.
 - **Main number** : You can select the one out of mobile, home, office that you often use. The main number will be displayed first, if you set this.

Add new [Names 2]

You can add phonebook entry by using this function.

Phone memory capacity is 200 entries. SIM card memory capacity depends on the service provider.

You can also save 12 characters of name in the Phone memory, and you can save characters in the SIM card. The number of character is SIM dependent feature.



1. Open the phonebook first by pressing  [Names] in standby mode.
2. Scroll to highlight **Add new**, and press  [Select] to enter.
3. Select the memory you want to save: **SIM** or **Phone**.
 - **SIM** : You can add name and number for entry.
 - a. Write a name to add.
 - b. Press  [OK], then you can input a number.
 - c. Press  [OK].
 - d. If you want to add the voice, press  [Yes].
 - **Phone** : You can add name, mobile, home, office, fax no. and E-mail address.
 - a. Write a name to add.
 - b. Press  [OK].
 - c. Enter the numbers following as mobile, home, office, and fax by pressing  [OK]. Also you can input E-mail address.
 - d. If you want to add the voice, press  [Yes].



You should speak a word within 2 seconds, and the phone asks you to speak it again to ensure the accuracy of voice recognition. After voice recognition has finished, Voice is attached automatically.

Note





- The voice can only be attached to main number which you set. For example, if you change main number voice will be automatically attached changed number.
- You can add voice tag to phone number in SIM card. The voice tag can be erased removing or changing SIM card. And voice tag attached to phone number in SIM card may be attached to another phone number when you changed SIM card. Why? The answer is that SIM card doesn't contain information about voice tag.

Speed dial [Names 3]

You can associate any of the keys  to  with a Name list entry. You can call directly by pressing this key for 2-3 seconds.

1. Open the phonebook first by pressing  [Names] in a standby mode.
2. Scroll to **Speed dial**, then press  [Select] to enter this menu.
3. Every Speed dial will be displayed.
4. If you want to add Speed dial, select <Is empty>. Then, you can search the name in phonebook.
5. If you select allocated name by speed dial, you can view following the submenus.
 - **Change** : You can change the allocation of speed dial number.
 - **Undo speed dial** : You can delete the allocated speed dial number.



Voice list [Names 4]

You can see all phone numbers which contain voice. You can also call directly by pressing  [Send]. After selecting phone number by using  and  and press  [Options], you can see following the submenus.

- **Play** : You can play voice which is attached to phone number.
- **Change** : You can change voice which is attached to phone number.
- **Delete** : You can delete voice which is attached to phone number.
- **Call** : You can call by selecting this menu.

Caller groups [Names 5]

You can list up to 20 members per one group. There are 7 groups you can make lists to.

1. Press  [Names] to enter into the phonebook in standby mode.
2. Scroll to **Caller groups** then press  [Select] to enter this menu.
3. Every Group list will be displayed: **Family, Friend, Colleague, VIP**, etc.
4. Select Group name that you want to manage by pressing  [Select].
5. Then submenus below will be displayed.

- **Add member**

You can add the number in Caller groups.

- **View member**

- You can view the number list in Caller groups.
- You can select the member you want by pressing  [Options] then you can enable the submenu such as **Edit, Delete**.



- **Group ring tone**
 - You can set the ring tone depending on Group.
- **Group icon**
 - You can set icon depending on Group.
- **Change name**
 - You can change and edit the Group name.

Note

- This menu “**Change name**” will be displayed only when you select “**Empty**”.





Copy all [Names 6]

You can copy/move entries from SIM card memory to Phone memory or from Phone memory to SIM card memory.

1. Open the phonebook first by pressing  [Names] in standby mode.
2. Scroll to **Copy all**, then press  [Select] to enter this menu.
3. Then submenus below will be displayed.
 - **SIM to Phone** : You can copy the entry from SIM Card to Phone memory.
 - **Phone to SIM** : You can copy the entry from Phone memory to SIM Card.



Delete all [Names 7]

You can delete all entries in **SIM**, **Phone** and **Voice**. This function requires security code.

1. Press  [Names] to enter into the phonebook in standby mode.
2. Scroll to **Delete all**, then press  [Select].
3. Then select a memory to erase: SIM, Phone, Voice.
4. And then you will be requested to enter Security code.
5. Press  [OK] or, press  [Back] to cancel.

Settings [Names 8]

You can set preferred memory which includes **Variable**, **SIM** or **Phone** and preferred search which includes **Variable**, **Name** and **Number**.

1. Open the phonebook first by pressing  [Names] in a standby mode.
2. Scroll to **Settings**, then Press  [Select] to enter.
3. Then submenus below will be displayed.

• Set memory

1. Scroll to highlight **Set memory**, then press  [Select] to enter.
2. The three submenus are displayed.
 - **Variable** : If you select Variable, the phone asks you where to store whenever you add entries in Phonebook.
 - **SIM** : If you select SIM, the phone stores entries to SIM directly without asking you where to store.
 - **Phone** : If you select Phone, the phone stores entries to Phone directly without asking you where to store.





• Search by

1. Scroll to highlight Search by, then press  [Select] to enter.
2. The three submenus are displayed.
 - **Variable** : If you select Variable, the phone asks you how to search the entries.
 - **Name** : If you select Name, the phone searches entries by name.
 - **Number** : If you select Number, the phone searches entries by number.

Information [Names 9]

SDN (Service Dial Number)



Use this function to access a particular list of services provided by your network operator (if supported by the SIM card).

1. Open the phonebook first by pressing  [Names] in a standby mode.
2. Scroll to **SDN**, then Press  [Select] to enter.
3. The names of the available services will be shown.
4. Use  and  to select a service. Press  [Send].

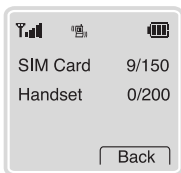
Check memory



This feature allows you to see how many free and in-use are in your phonebook.

1. Open the phonebook first by pressing  [Names] in standby mode. Select **Information** by pressing  [Select].
2. Scroll to **Check memory**, then press  [Select] to enter this menu.

Own number (SIM dependent)

You can check your own number in SIM card.



1 Messages

- 1 Write message
- 2 Inbox
- 3 Outbox
- 4 Info service
- 5 Voice messages
- 6 Namecard
- 7 Templates
- 8 Settings
- 9 Check memory



2 Call Register

- 1 Missed calls
- 2 Received calls
- 3 Dialed calls
- 4 Clear recent calls
- 5 Call charge



3 Profiles

- 1 Vibrate only
- 2 Quiet
- 3 General
- 4 Loud
- 5 Headset



4 Settings

- 1 Alarm clock
- 2 Date & Time
- 3 Phone settings
- 4 Call settings
- 5 Security settings
- 6 Network settings
- 7 Restore factory settings



5 Call Divert

- 1 All voice calls
- 2 If busy
- 3 If no reply
- 4 If unreachable
- 5 All data calls
- 6 All fax calls
- 7 Cancel all



6 Scheduler

- 1 Add new
- 2 View day
- 3 View all
- 4 Delete passed
- 5 Delete all



7 Fun & Tools

- 1 Game
- 2 Unit convert
- 3 Calculator
- 4 World time



8 Internet

- 1 Home
- 2 Bookmarks
- 3 Profiles
- 4 Go to URL
- 5 Cache settings
- 6 Security certifications
- 7 Reset profiles





9 Sim Service

This menu depends on SIM and the network services.

This menu includes functions related to SMS (Short Message Service), voice mail, as well as the network's service messages.



Write message [Menu 1-1]

You can write and edit text message up to 1024 characters. Also, you can check the number of characters.

1. Enter the **Messages** menu by pressing  [Select].
2. If you want to write a new message, select **Write message** in the menu.
3. To write a message, use T9 text. For details, see **How to Use T9** (Page 33).
4. When you finish writing your message, press  [Options]. Then following option menu will be displayed.



Send

Sends the text message.

1. If you want to send the text message, enter the number you want.
2. Your phone asks you to enter the number that you want to send it to.
3. After sending it, your phone asks whether you will store the edited message.
4. Press  if you want to store it in Outbox and press  if you don't want to.

Save

Stores the message in Outbox.

1. Your phone asks whether you will save the edited message.
2. Press  if you want to save it in Outbox and press  if you don't want to.

Use template



The template is pre-defined message. You can add the template of the list to the message when you edit it.

Use namecard

The items of the name card are a name, mobile, office, and memo. You can add a namecard to the message.

Add dictionary

If you add a word you use often, you can input it by pressing a key once for each character.



1. Enter the menu.
2. Scroll to highlight **Add dictionary**, and then press  [Select].
3. Input a word, and then press  [Save].

How to Use T9

T9 allows you to input text quickly.

In T9, you only need to press the key with the corresponding letter once. This is based on a built-in dictionary to which you can also add new words.

• Writing words by using T9.

1. Start writing a word by using the keys  to . Press each key only once for one letter. To write for instance 'Girl'.

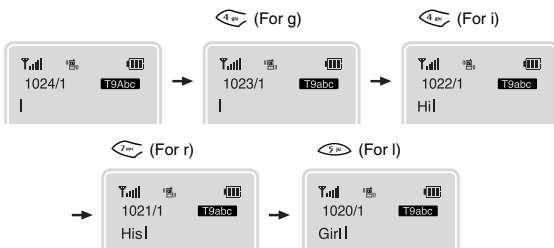



The word changes after each keystroke. Therefore you shouldn't pay too much attention to how the word appears on the display until you have pressed all the appropriate keys.

To delete a character to the left, press .

To insert several numbers, hold  down and key in the numbers.

If you hold  down, you can change the T9 languages. In T9 mode, you can also select T9 Off menu. (Default is T9 On)

Also, the phone supports three modes: **Predictive** (T9Abc, T9ABC, T9abc), **Multitap** (ABC, abc), **Numeric** (123). If you want to change a mode, press  key.

Alternatively : Press  key and select insert symbols. Select the desired character and press **Select**.

2. When you have finished writing a word, check whether the word is correct.

• **If the word is correct:**

Press  and write the next word.

• **If the word is not correct:**

Search by ,  (**Previous** and **Next word**).

• **Alternatively:**

If there is no word you want you can add your own word. Press  [Options] in the Predictive edit mode. Select Add T9 dictionary Menu. You can see the following.

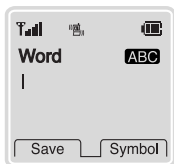

Input your
word

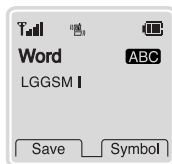



3. To insert a punctuation mark, press  repeatedly until the desired mark appears.

T9 languages

- You can select T9 Languages by selecting Menu. In T9 mode, you can also select T9 Off menu. (Default is T9 On)

Inbox [Menu 1-2]

When you receive a text message, your phone shows the symbol and stores it in the incoming message lists. Scroll to the desired message by using  , . In addition, you can see Delete all for deleting all incoming messages at the bottom of the list. While reading the message, press  [Options] to access the available options.

Delete

The selected message is deleted.

Edit

You can edit an incoming message and send or save the edited message.

Forward

You can forward the selected message to the other party.

Get number

If the selected message has the phone number, you can extract and save it in a phonebook. Also, you can call by this number.





Reply

You can reply to the sender by message.

Return call

You can call back to the sender who sent the message automatically.

Outbox [Menu 1-3]

When you enter this menu, you can see the message(s). Scroll to the desired message by using ,  and press  to see the message. And if you want to exit **Outbox** menu, press .

And if you want to exit outbox menu, press . In addition, you can see **Delete all** for deleting all outgoing messages at the bottom of the list.

After reading message, press  [Options] to access the following submenus.

Delete

The selected message is deleted.

Edit

You can edit an outgoing message and send or save it.

Forward

You can forward the selected message to the other party.

Get number

If the selected message has the phone number, you can extract and save it in a phonebook. Also, you can call by this number.

Info service [Menu 1-4] (Dependent to network and subscription)

Cell Broadcast messages (CB Message) are text messages by the network to GSM phone users. They provide general information such as weather reports, traffic news, taxis, pharmacies, and stock prices. Each type of information has the number; therefore, you can contact service provider. When you receive CB message, you can read it following sequence:

Read [Menu 1-4-1]

1. When you receive CB message, it will be displayed on the screen. You can read the message by scrolling (↶) , (↷).
2. After reading the message, press (⏏) to return to the standby mode. In addition, you can save it until another message is reached.

Receive CB [Menu 1-4-2]

• Yes

If you select this menu, your phone will receive the Cell Broadcast message.

• No

If you select this menu, your phone will not receive the Cell Broadcast message any more.

Alert [Menu 1-4-3]

• Yes

If you select this menu, your phone will beep when Cell broadcast message is received.

• No

If you select this menu, your phone will not beep despite Cell broadcast message is received.

Language [Menu 1-4-4]

You can select the language you want. Then your phone will receive the cell broadcast message in the language selected by you.

You can select Cell broadcast language pressing  [Select]. The language list which you selected already will be displayed with check box.

Topics [Menu 1-4-5]

(Dependent to network and subscription)

- **Add [Menu 1-4-5-1]**

If you select this menu, you will add the CB message category in Phone memory.

- **View list [Menu 1-4-5-2]**

If you select this menu, you can see CB message category. If you press  [Options], you can edit and delete it.

- **Active list [Menu 1-4-5-3]**

You can select the CB message category in active list by pressing  [Select].

Voice messages [Menu 1-5]

You can listen to your voice message(s) and get the voicemail centre number.

Listen to voice message [Menu 1-5-1]

You can call voicemail centre if you want to listen to voice message.

Voice mailbox number [Menu 1-5-2]

You can get the voicemail if this feature is supported by the network service provider. When new voicemail is arrived, the symbol will be displayed on the screen. Please check with your network service provider for details of their service in order to configure the handset accordingly.

1. Press  key for a long time in standby mode.
2. You can check the following submenus.

- **Home [Menu 1-5-2-1]**

The number dialed on the home network to listen to voicemail.

- **Roam [Menu 1-5-2-2]**

The number dialed when other networks to listen to voicemail.

Namecard [Menu 1-6]

It's for editing the namecard. The items of the namecard are a name, mobile, office, and memo.

- **Edit** : You can edit a namecard.
- **Delete** : You can delete a namecard.

Templates [Menu 1-7]

It's for editing pre-defined messages. You can see 11 pre-defined messages in the list. You can save 6 templates before you edit. But you can change them. The others are <Empty>.

- **Edit** : You can edit a template.
- **Delete** : You can delete the template.

Settings [Menu 1-8]

Message type [Menu 1-8-1]

Text, Voice, Fax, Natl. paging, X400, E-mail, ERMES

Usually, the type of message is set to **Text**. You can convert your text into alternative formats, which are suitable for the device that will be received the message. Contact your service provider for the availability of this function.

Validity period [Menu 1-8-2]

This network service allows you to set how long your text messages will be stored at the message center while attempts are made to deliver them to you.

Status report [Menu 1-8-3]

If you set **Yes** in this menu, you can check whether your message is sent successfully or not.

Pay for reply? [Menu 1-8-4]

When a message is sent, it allows the person to whom you sent the message to reply and charges the cost of the reply to your telephone bill.

SMS centre [Menu 1-8-5]

If you want to send the text message, you can get the address of SMS center thru this menu.

Check memory [Menu 1-9]

If you select this menu, the phone shows an used memory and total amount of memory. The total memory is the sum of SIM and Phone memory.

Missed calls [Menu 2-1]

This menu shows recent missed call number(s). You can call by this number, save it or view date and time in this menu.

Received calls [Menu 2-2]







You can check the recent received numbers. You can call by this number, save it or view date and time in this menu.

Dialled calls [Menu 2-3]

You can check the recent dialled numbers. You can call by this number, save it or view date and time in this menu.

Clear recent calls [Menu 2-4]

You can delete all call records.





1. Press  [Menu] in standby mode.
2. Press  for direct access or use  and  to enter **Call register**.
3. Scroll to highlight **Clear recent calls** and press  [Select] to enter.
4. The following four submenus : Missed calls, Received calls, Dialled calls, All calls.
5. **Delete all** message will be displayed and then press  [Select], then, press one more time  [Yes] to confirm.

Call charge [Menu 2-5]

Within these submenus, you can view the duration and the call cost.

Call duration [Menu 2-5-1]





This function allows you to view the duration of your Last Call, All Calls, Incoming Calls and Outgoing Calls in hours, minutes and seconds. You can also reset the call timers.

1. Press  [Menu] in standby mode.
2. Press  for direct access or use  and  to enter **Call register**.
3. Scroll to highlight **Call duration** and press  [Select].

The following 5 submenus: **Last call**, **All calls**, **Received calls**, **Dialled calls** and **Reset all**.

Show call costs [Menu 2-5-2]

This function allows you to check the cost of your last call, all calls, remaining and reset the costs. To reset the cost, you need the PIN2 code.

1. Press  [Menu] in standby mode.
2. Press  for direct access or use  and  to enter **Call register**.
3. Scroll to highlight **Show call costs** and Press  [Select] to enter.

The following 4 submenus: **Last call**, **All calls**, **Remaining** and **Reset all**.





Note

- The actual call cost may be different depending on network features, billing, and tax.

Cost settings [Menu 2-5-3] (SIM Dependent)





• Set tariff [Menu 2-5-3-1]

You can set the currency type and the unit price. Contact your services providers to obtain charging unit prices. To select the currency or unit in this menu, you need the PIN2 code.

1. Press  [Menu] in standby mode.
2. Press  for direct access or use  and  to enter **Call register**.
3. Scroll to highlight **Cost settings** and press  [Select] to enter.
4. Select **Set tariff**.

• Set credit [Menu 2-5-3-2]

This network service allows you to limit the costs of your calls by selected charging units. If you select **Read**, the number of remaining unit is shown. If you select **Change**, you can change your charge limit.

1. Press  [Menu] in a standby mode.
2. Press  for direct access or use  and  to enter **Call register**.
3. Scroll to highlight **Cost settings** and press  [Select] to enter.
4. Select **Set credit**.

Note





- When all units have been used, no calls can be made except emergency calls. Depending on SIM card, you need the PIN2 code to set a call cost limit.

Call Register [Menu 2]





Accessing the Menu

- **Auto display [Menu 2-5-3-3]**

This network service allows you to see automatically cost of your last call. If you select **Yes** in **Auto display** menu, you can see the last cost when the call is released.

1. Press  [Menu] in standby mode.
2. Press  for direct access or use  and  to enter **Call register**.
3. Scroll to highlight **Settings** and press  [Select] to enter.
4. Select **Auto display**.

In this menu, you can adjust and customize the phone tones for different events, environments and caller's group. (e.g. When your phone is connected to the Handsfree kit, it'll be automatically set to the Car profiles menu and when your phone is connected to the Earmic, it'll be automatically set to Headset profiles menu.)

1. Press  [Menu] in standby mode.
2. Press  for direct access or use  and  to enter **Profiles**.

Note

- In case that your phone is connected to accessories such as Earmic and Handsfree, you cannot enable Profiles menu manually.
- Profiles menu has "Enable" submenu except Headset and Car so that you can set Profiles menu at any time except above case.

Vibrate only [Menu 3-1]

- **Enable** : You can adjust the Profiles as Vibrate only if you need vibration mode.

Quiet [Menu 3-2]

- **Enable** : You can adjust the Profiles as Quiet if you are in Silent place.
- **Change** : You can change the values of Profiles submenus.

General [Menu 3-3]

- **Enable** : You can adjust the Profiles as General
- **Change** : You can change the values of Profiles submenus.

Loud [Menu 3-4]

- **Enable** : You can adjust the Profiles as Loud if you are in a noisy environment.
- **Change** : You can change the values of Profiles submenus.

Headset [Menu 3-5]

- **Change** : You can change the values of Profiles submenus.

A Group of Profiles submenus [Menu 3-x-x]

Profiles menu have the submenus as shown below.

Incoming alert type [Menu 3-x-1]

Allows to set alert type for the incoming call for adjusting environment.

Ringling tone [Menu 3-x-2]

Allows to set the ringling tone for adjusting environment.

Ringling volume [Menu 3-x-3]

Allows to set the ringling volume for adjusting environment.

Message alert [Menu 3-x-4]

Allows to alert when receiving a message for adjusting environment.: **Beep**, **Vibrator**, and **No alert**.

Key volume [Menu 3-x-5]

Allows to set the keypad volume for adjusting environment.

Automatic answer [Menu 3-x-6]

Allows to set to answer automatically for adjusting environment.

Please note that only Car and Headset has this sub menu so that you can activate this function.

- **Disable**

Even though your phone is ringing, your phone will not answer automatically.

- **After 5 secs**

After 5 seconds your phone will answer automatically.



- **After 10 secs**

After 10 seconds your phone will answer automatically.

Note

- If you set the Handsfree kit to the phone, you can't activate the vibration related with Incoming alert type or Message alert menu. Therefore, in Car menu, you can view the following submenus;
 - **Incoming alert** : Ring, Silent
 - **Message alert** : Beep, No alert

You can set the following menus for your convenience and preferences.



1. Press  [Menu] in standby mode.
2. Press  for direct access to enter Setting.

Alarm clock [Menu 4-1]

You can set the phone to alarm at a specified within this menu.



Enable [Menu 4-1-1]

You can set the time (Hour and Minute) for raising the alarm.

1. Enter the menu.
2. Select Enable by pressing  [Select], and then enter the alarm time you want.
3. Press  [OK].
4. Select the repeat period: **Once**, **Daily**, **Weekly**, and **Monthly**.
5. If you set in Power off alarm, the alarm signal sounds at the time you set even if the phone is turned off.

Disable [Menu 4-1-2]

You can cancel setting the alarm time.



1. Enter the menu.
2. Select **Disable** by pressing  [Select].
3. **Clear alarm** message will be displayed when the phone is set to alarm before.
4. If you want to cancel, press  [Yes]. If not, press  [No].

Date & Time [Menu 4-2]

Date [Menu 4-2-1]

• Set date

In this menu, you can set the date of your phone.

1. Enter the menu.
2. Select Set date by pressing  [Select].
3. Enter the number you want to set the date.
4. Press  [OK].

• Date format

You can set the Date format in this menu.





Time [Menu 4-2-2]

The phone has its own clock. In this menu you can set the time and select between the 12-hour or 24-hour time formats.

1. Enter the menu.
2. Scroll to highlight Time by pressing  [Select].



• Set time:

You can set time of your phone in this menu.

1. Select Set time by pressing  [Select].
2. Enter the number you want to set the time.
3. Select the **am/pm** you want to set the time format by long pressing  ,  key.
4. Press  [OK].

• Time format:

Your can select time format between 12-hour or 24-hour.

1. Scroll to highlight Time format by pressing  [Select].
2. Select 12 hour or 24 hour you want by pressing  [Select].

Phone settings [Menu 4-3]

You can set the phone setting you want. Scroll to highlight **Phone settings** menu, and then press  [Select].

Display [Menu 4-3-1]

- **Screen saver [Menu 4-3-1-1]**

If you don't activate any function for 20 seconds, the picture will be displayed in a standby mode.

- **Welcome note [Menu 4-3-1-2]**



This menu allows you to set the message, which is shown briefly when the phone is switched on.

1. Select **Settings – Phone settings – Display – Welcome note**.
2. Your own text can be displayed. If you select this item, your phone asks you to edit the message.

- **Backlight [Menu 4-3-1-3]**

You can set the light-up duration you want whenever you press a key.

- **LCD contrast [Menu 4-3-1-4]**

You can set the brightness of LCD you want by pressing  , .

Language [Menu 4-3-2]

You can select the language that will be displayed on the phone.

Call settings [Menu 4-4]



You can set the menu relevant to a call by pressing  [Select] in Setting menu.

Minute minder [Menu 4-4-1]



If you select Yes, you can check the call duration by beep sound every minute during a call.

Any key answer [Menu 4-4-2]

- **Yes [Menu 4-4-2-1]**

If you select this menu, you can receive an incoming call by pressing any key except  key and  key

- **No [Menu 4-4-2-2]**

If you select this menu, you can receive an incoming call by  [Answer] or .

Note

- **How to use Handsfree portable:**

If you want to use the handsfree portable (earphone), please press the button for a long time after inserting it to the connector when incoming a call.

Send number [Menu 4-4-3] (network and subscription dependent)

- **Yes [Menu 4-4-3-1]**

If you select this, you can send your phone number to the other party. That is, your phone number will be displayed on receiver's phone.

- **No [Menu 4-4-3-2]**

If you select this, you can't send your phone number.

- **Default [Menu 4-4-3-3]**

If you select this menu, this phone will be set to the default value.

Call waiting [Menu 4-4-4] (network dependent)

If this service is available, you can accept a waiting (incoming) call.

- **Enable [Menu 4-4-4-1]**

Activating the corresponding service.

- **Disable [Menu 4-4-4-2]**

Deactivating the corresponding service.

- **Check status [Menu 4-4-4-3]**

Checking the Status of the service.

Auto redial [Menu 4-4-5]

- **Yes [Menu 4-4-5-1]**

When this function is set on, your phone will make up to 10 attempts for a call after not connecting.

- **No [Menu 4-4-5-2]**

Your phone will not make any attempts to connect the call after not connecting.

Next incoming [Menu 4-4-6]

(network dependent)

In case of Single Numbering Service, you can use the phone and a connected PC to send and receive fax, data, and voice. If you select the mode, you can receive data, fax, or voice each mode. Once you enter this menu, you following options are displayed.

- **Voice**

You can receive the voice call.

- **Data**

You can receive the data call.

- **Fax**

You can receive the fax call.

Note

- Single numbering service means that the number of fax or data service is identical with the number of voice service. And, these modes depend on network feature.

Select line [Menu 4-4-7]

(network dependent)





This function is only used if **Alternate line service** supported by the Service Provider. Two independent phone numbers are registered for the phone. This function provides you with the selection the currently used phone number. If this function is supported by your service provider, the following menu will be displayed.

1. **Line 1** : Select Line 1 as the current phone number.
2. **Line 2** : Select Line 2 as the current phone number.

Security settings [Menu 4-5]

PIN code [Menu 4-5-1]

In this menu, you can set the phone to ask for the PIN code of your SIM card when the phone is switched on. If this function is activated, you'll be requested to enter the PIN code.

1. Press  [Menu] in standby mode.
2. Press  key for direct access or use  and  to enter **Settings**.
3. Scroll to highlight **Security settings** menu.
4. Select PIN code by pressing  [Select].
5. You can view the following submenus.
 - **Enable** : Enable PIN code request.
 - **Disable** : Disable PIN code request.

Phone lock [Menu 4-5-2]

You can use security code to avoid unauthorized use of your phone. When you switch on your phone, your phone will request security code always if you set phone lock to "Enable". If you set phone lock to "Automatic", your phone will request security code only when you change your SIM card.



- **Enable**
- **Disable**
- **Automatic**

Automatic key lock [Menu 4-5-3]

When you enable Automatic key lock, keypad will be lock automatically on an idle screen after 25 seconds without any key requesting.

- **Enable**
- **Disable**

Note

- If you want to lock your phone keypad manually, enter Top menu and press  key.
- If you want to unlock your phone keypad, press [unlock] key and then press  key. But if you enabled Automatic key lock before, your phone keypad will be unlock and then after 25 seconds the keypad will be lock up again automatically.

Call barring [Menu 4-5-4]

The Call barring service prevents your phone from making or receiving certain category of calls. This function requires the call barring password. You can view the following submenus.

• All outgoing:

The barring service of all outgoing calls.

• Outgoing Intl:

The barring service of all outgoing international calls.

• Outg. intl roam:

The barring service of all international outgoing calls except home network.

• All incoming:

The barring service of all incoming calls

• Inc when roam:

The barring service of all incoming calls when roaming

• Cancel all:





You can cancel all barring service.

• Change passwd:

You can change the password for Call Barring Service.







Fixed dial num [Menu 4-5-5] (SIM dependent)

You can restrict your outgoing calls to selected phone number. The numbers are protected by your PIN2 code.

1. Press  [Menu] in standby mode.
2. Press  key for direct access or use  and  to enter **Settings**.
3. Scroll to highlight **Security settings** menu.
4. Select PIN code by pressing  [Select].
5. If the PIN 2 code is correct, you can view the following submenus.
 - **On** : You can restrict your outgoing calls to selected phone number.
 - **Off** : You can call without restricting phone number.
 - **Number list** : You can view the number list saved as Fixed dial number.

Change code [Menu 4-5-6]

You can change the access codes: **PIN code**, **PIN2 code**, and **Security code**.

1. Press  [Menu] in standby mode.
2. Press  key for direct access or use  and  to enter **Settings**.
3. Scroll to highlight **Security settings** menu.
4. Select **Change code** by pressing  [Select].
5. If you want to change the PIN/PIN2/Security code, input your original code, and then press  [OK].
6. Input new PIN/PIN2/Security code, and verify them.

Network settings [Menu 4-6]

You can select the network which you will be registered either automatically or manually. Usually, the selection of the network used by the handset is automatic.

Automatic [Menu 4-6-1]

The phone automatically selects network which is available in the your area.

Manual [Menu 4-6-2]

The phone will find the list of available networks and show you them. Then you can select the network which you want to use if this network has a roaming agreement with your home network operator.

Preferred [Menu 4-6-3]

You can set a list of preferred networks the handset should attempt to register with first, before attempting to register to any other networks. This list is created from the handset's predefined list of known networks.

User define [Menu 4-6-4]

You can add entries or delete new ones from the network list. This can even include new networks whose network codes are not known to the handset. To do this, select and then enter the network code, country code and network name.

Restore factory settings [Menu 4-7]





You can set the handset to the default configuration by selecting the Settings/Restore factory settings option, and then confirming this selection.

Call Divert [Menu 5]

Accessing the Menu

(network and subscription dependent)

The Call divert service allows to divert incoming voice calls, fax calls, and data calls to another number. For details, contact your service provider.

1. Press  [Menu] in standby mode.
2. Press  for direct access or use  and  to enter **Call Divert**.

All voice calls [Menu 5-1]

Diverts voice calls unconditionally.

If busy [Menu 5-2]

Diverts voice calls when the phone is in progress.

If no reply [Menu 5-3]

Diverts voice calls which you do not answer.

If unreachable [Menu 5-4]

Diverts voice calls when the phone is switched off or out of range.

All data calls [Menu 5-5]

Diverts to a number with a PC connection unconditionally.

All fax calls [Menu 5-6]

Diverts to a number with a fax connection unconditionally.

The submenus [Menu 5-x-x]

Call Divert menus have the submenus as shown below.

Enable [Menu 5-x-1]

Activating the corresponding service.

- **Voicemail box [Menu 5-x-x-1]**

Forwards to message center. This function is not included in **All data calls** and **All fax calls** menus.

- **Other number [Menu 5-x-x-2]**

Inputs the number for diverting.

- **Favorite [Menu 5-x-x-3]**

Shows the list of 5 diverting numbers.

Note

- You can select the number you want in **Favorite** menu.

Disable [Menu 5-x-2]

Deactivating the corresponding service.

Check status [Menu 5-x-3]

Checking the Status of the corresponding service.

Cancel all [Menu 5-7]



Cancels all call divert service.

Scheduler [Menu 6]

Accessing the Menu

When you enter this menu a Calendar will show up. On top of the screen there are sections for date and icons. Whenever you change the date, the calendar will be updated according to the date. And square cursor will be used to locate the certain day. If you see under bar on the calendar, it means that there is a schedule that day. This function helps to remind you of your schedule and memo. The phone will sound an alarm tone if you set alarm for the note.

For changing the day, month, and year.

Key	Description
	Yearly
	Monthly
	If you press these keys shortly, you can set the alarm daily. In case of pressing for a long time, you can set it weekly.

Add new [Menu 6-1]

You can edit maximum 30 characters. You can take a note. You can choose the following types of note. You can make up to maximum 20 notes.

Schedule [Menu 6-1-1]

Input the subject, the schedule time, the repeat time, alarm time by pressing  [Select].



• Repeat [Menu 6-1-1-1]

- **Once** : no repeat.
- **Daily** : repeat schedule daily for 5 days.
- **Weekly** : repeat schedule weekly for 5 weeks.
- **Monthly** : repeat schedule monthly for 5 months.
- **Yearly** : repeat schedule yearly for 5 years.



• Alarm time [Menu 6-1-1-1]

- **On time** : alarm on time you set already.
- **10 min before** : alarm before 10 minutes from the schedule you set already.
- **30 min before** : alarm before 30 minutes from the schedule you set already.
- **1 hour before** : alarm before 1 hour from the schedule you set already.
- **1 day before** : alarm before 1 day from the schedule you set already.



Memo [Menu 6-1-2]

1. Select **Add new** by pressing  [Select].
2. Scroll to highlight **Memo**.
3. Press  [Select].
4. Input the memo and then press  [OK].

View day [Menu 6-2]

Shows the note for the chosen day. Use  ,  to browse through the note lists. If you set alarm for the note, Alarm watch is displayed. Press  [Options] to delete, edit the note you selected.

View all [Menu 6-3]

Shows the notes that are set for all days. Use  ,  to browse through the note lists. Pressing  [Options] allows access to the same menu as in 'View day'.

Delete passed [Menu 6-4]

You can delete for the last schedule already notified you.

Delete all [Menu 6-5]

You can delete for the all note(s).











Game [Menu 7-1]

Your phone offers you enjoyable games to play with.

Note

The Control keys are different for each game. But each game has screens to explain the main control key. Other common control keys are below.



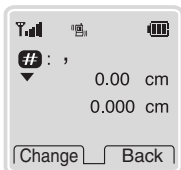

[Common Key Function]

-  [Soft 1 Key] : Start Game
-  [CLR] : Exit
-  [Soft 2 Key] : Exit
-  [END] : Exit
-  [Star Key] : Backlight off/on
-  [Soft 1 Key] : Save score
-  ,  ,  ~  : Level control
[Up/Down, numeric key]

Unit convert [Menu 7-2]



This converts any measurement into a unit you want. There are 4 types that can be converted into units: **Length**, **Area**, **Weight**, and **Volume**.

1. You can select one of four unit types by pressing  [Select] key.
2. Select the unit you want to convert by pressing  and .
3. You can change unit by pressing  [Change] key.
4. You can input the prime number after the decimal place by pressing  key.

5. You can delete the number you want by pressing D/C .
6. Press C key or [Back] key if you want to end the process for converting the value.

Calculator [Menu 7-3]

This contains the standard functions such as $+$, $-$, $*$, \div : **Add, Subtract, Multiply, Divide**

1. Input the numbers by pressing numeric keys.
2. Press [Options] to select menu you want such as Add, Subtract, Multiply, Divide, Negative, Decimal point, Equal.
3. You can view the result by pressing [Options] key and select **Equal**.
4. If you want to continue the calculation, repeat the process.
5. You can delete the number or sign you want by pressing D/C .
6. Press C key or [Back] key if you want to end the calculation process.

World time [Menu 7-4]

You can view the time for each city around the world.

When you press [City] , [City] shortly, you can view the city belonged to the different time zone and when you press [City] , [City] long, you can view the all of city on the same time zone.

If you want to select the country you want, press [Set] key.



Home [Menu 8-1]

You can connect to the configured homepage of the activated profile.

Note

- G1500 can access only Operator's Home page website for viewing and information purpose only.

Bookmarks [Menu 8-2]

When you enter this menu, you can see the bookmarks. Then press  button to access available option, or press  to exit it.

- **Connect** : Connect to selected bookmark.
- **Add new** : Add a new bookmark manually.
- **Edit** : Edit the title and the address of the selected bookmark.
- **Delete** : Delete the selected bookmark from the bookmark list.

Profiles [Menu 8-3]

You can make up to 5 profiles and activate only one of them. Scroll to the desired profile and press  to access available options.

• **Activate [Menu 8-3-1-1]**

You can activate the selected profile.

• **Settings [Menu 8-3-1-2]**

You can edit and change WAP settings of the selected profile.

- Homepage

This setting allows you to enter the address (URL) of the site you want to use as homepage. You do not need to type "http://" in front of each URL as the WAP Browser will automatically add it.

- Display image

You can select whether images on WAP cards are displayed or not.

- Conn. type

The options for connection type are Continuous or Temporary and depend on the gateway.

Continuous

A confirmed delivery mechanism but generates more network traffic.

Temporary

A non-confirmed (connectionless) service.

- Secure setting

The options are **On** and **Off** depend on the gateway you are using.

- Gateway info.

Most of WAP gateways do not require a User ID and Password. If your gateway need them to connect to it, then your network should provide them, and you must set them up correctly before trying to browse a WAP site.

- Data setting

These values of setting are provided by your network.

IP address : Enter the IP address of the WAP gateway you are using to access.

- Dial number** : Enter the telephone number to dial to access your WAP gateway.
- Call type** : Select the type of data call.: Analogue or ISDN (Digital).
- Call speed** : The speed of your data connection.
- User ID** : The user identity for your dial-up server (and NOT the WAP gateway).
- Password** : The password required by your dial-up server (and NOT the WAP gateway) to identify you.

- Linger time

You need to select one of 5 timeout periods. After selecting one of them, the service will be unavailable if any data wasn't input or transferred.

• Rename [Menu 8-3-1-3]

Edit the Profile Name.

• Email server [Menu 8-3-1-4]

Save the URL of the E-mail server that you frequently use.

- Connect

Connect to the E-mail server that you configured.

- Edit address

Edit the URL of the E-mail server.

Go to URL [Menu 8-4]

You can directly connect to the site that you want. You need to enter the specific URL that you want to directly connect.

Cache settings [Menu 8-5]

You can remove the contents of Cache memory and change the Cache check mode.

Clear cache [Menu 8-5-1]

The contents of Cache memory will be removed.

Cache check [Menu 8-5-2]

You can change the time for checking the Cache memory.

- **Always [Menu 8-5-2-1]**

The cache is always checked whenever URL is loaded or navigated.

- **Start only [Menu 8-5-2-2]**

The cache is only checked when the WAP is started.

- **Off [Menu 8-5-2-3]**

The cache is never checked.

Security Certifications [Menu 8-6]

A list of the available certificates is shown.

Reset profiles [Menu 8-7]

You can reset all the current settings of profiles to the factory default.

If you are on line, you can see the following menus.

Home

This is the same as [Menu 8-1].

Reload

This reloads the current page.

Bookmarks

This is the same as [Menu 8-2].

Save as bookmarks

Save the current URL as a bookmark. You can also edit the bookmark title.

Go to URL

Same as [Menu 8-4].

Go to e-mail server

Connect to the E-mail server that you configured.

Set as e-mail server

Save the current URL as an E-mail server.

To be able to data or fax service, you need the communicate software such as a data or a fax program. Before using these functions, you need to connect your phone to a computer or make sure that your phone is in connection with a compatible device.

Sending Data or Fax Calls

1. Connect your computer to the phone.
2. After starting the communicate software, make a call and transmit a data or fax.
3. After the data or fax transmission, you can end the call by just ending of the communicate software, pressing  [End].

Receiving Data or Fax Calls

If you have separate numbers for voice, data and fax calls, your phone recognizes the type of call.

Receiving Data or Fax Calls – Separate numbers (Multi-numbers)

To use a data or a fax service, the display shows which type of call you are receiving.

To receive a data or fax call



1. Connect your computer to the phone.
2. After starting the communicate software, accept a call and receive a data or fax (if it is not answered automatically).
3. After the data or fax reception, you can end the call by just ending of the communicate software, pressing  [End].

Receiving Data or Fax Calls—Single number

If you have a SIM card that does not support separate voice, data and fax numbers, the phone does not recognize the type of incoming call.

To use a data or a fax service, make sure that you want to receive a data or fax call mode. You first have to set the phone to one of these options in the call mode (Settings → Call Setting → Next Incoming) sub menu.

To receive a data or fax call



1. Press  [Menu] in standby mode.
2. Select the Settings → Call setting → Next Incoming.
3. Select the call type you want (Voice, Data or Fax) and press  [Select].
4. Connect your computer to the phone.
5. After starting the communicate software, accept a call and receive a data or fax (if it is not answered automatically).
6. After the data or fax reception, you can end the call by just ending of the communicate software, pressing  [End].

Once you have set your phone for a specific incoming call, it remains set until you change it.



During a call, the following menus will be displayed, not in a standby mode.

1 During a call



1-1 Putting a Call on Hold

You can place a call on hold or retrieve by just pressing the  [Send] key. When a call is made or answered, press the  [Send] key to place it on hold. When a call is held, press the  [Send] key to make it active.

1-2 Making a Second Call

You can get a dial number from phonebook to make a second call. Press  [Names] key then select **Search**. To save the dial number into phonebook during call, press  [Names] key then select **Add Entry**.

1-3 Swapping Between Two Calls



To switch between two calls, select the  [Options] key, then select **Swap** or just press  [Send] key.

You can make one of two calls focused by pressing up/down arrow key. If you want to end one of two calls, make the call you want to end focused, then press  [End] key when the call you want to end is focused.

1-4 Answering an Incoming Call

To answer an incoming call, simply press the  [Send] key.



The handset is also able to warn you of an incoming call while you are already in a call. A tone sounds in the earpiece, and the display will show that a second call is waiting.

If Call Waiting is on, you can put the first call on hold and answer the second, by pressing  [Send] or by selecting the  [Menu] key, then **Hold & Answer**.

You can end the current call and answer the waiting call by selecting the  [Menu] key, then **End & Answer**.

1-5 Rejecting an Incoming Call



You can reject an incoming call without answering by simply pressing the  [End] key.

When in a call you can reject an incoming call by pressing the  [Menu] key and selecting **Multiparty/Reject** or by pressing  [End] key.

1-6 Controlling the volume during a call

You can control the volume during a call by pressing  [Options] key and selecting **Volume**.

1-7 Muting the Microphone

You can mute the microphone during a call by pressing the  [Options] key then selecting **Mute**. The handset can be unmuted by pressing the .

When the handset is muted, the caller cannot hear you, but you can still hear them.

1-8 Switching DTMF Tones on During a Call

To turn DTMF tones on during a call, for example, to allow your handset to make use of an automated switchboard, select the  [Options] key, then **DTMF On**. DTMF tones can be turned off the same way.

1-9 Calling up the Main Menu

The Messages and SIM Tool kit main menu options can be reached from the in-call menu by selecting the  [Options] key, then **Main Menu**. SIM Tool kit menu is shown only when SIM in the handset supports SIM Tool kit service.



2 Multiparty or Conference Calls

The multiparty or conference service provides you with the ability to have a simultaneous conversation with more than one caller, if your network service provider supports this feature.

A multiparty call can only be set up when you have one active call and one call on hold, both calls having been answered. Once a multiparty call is set up, calls may be added, disconnected or separated (that is, removed from the multiparty call but still connected to you) by the person who set up the multiparty call. These options are all available from the in-call menu and are listed in Section.

The maximum callers in a multiparty call is five. Once started, you are in control of the multiparty call, and only you can add calls to the multiparty call.

2-1 Making a Second Call

You can make a second call while you are already in a call. To do this, enter the second number and press  [Send]. When you get second call the first call is automatically put on hold. You can swap between calls by selecting the  [Options] key then **Swap**.

2-2 Setting up a Multiparty Call

You can connect a call on hold to the currently active call to form a multiparty call by selecting the  [Options] key then **Multiparty/Join all**.

2-3 Putting the Multiparty Call on Hold

To put a multiparty call on hold, select the  [Options] key then **Multiparty/Hold all**.



2-4 Activate the Multiparty Call on Hold

To make a multiparty call on hold active, select the  [Options] key then **Multiparty/Join all**.

2-5 Adding Calls to the Multiparty Call

To join an active call to the held multiparty call, select the  [Options] key then **Multiparty/Join all**.

2-6 Displaying Callers in a Multiparty Call

To scroll through the numbers of the callers who make up a multiparty call on the handset screen, press  and  keys.



2-7 Putting a Member of a Multiparty Call on Hold

To place one selected caller (whose number is currently displayed on-screen) of a multiparty call on hold, select the  [Options] key then **Multiparty/Exclude**.

2-8 A Private Call in a Multiparty Call

To have a private call with one caller of a multiparty call, display the number of the caller you wish to talk to on the screen, then select the  [Options] key and **Multiparty/Private** to put all the other callers on hold.

2-9 Ending a Multiparty Call

The currently displayed caller of a multiparty call can be disconnected by pressing the  [End] key. To end a multiparty call, press the  [Options] key then select **Multiparty/End multiparty**.

Selecting the  [Options] key then **Multiparty/End all**, will end all the active and held calls.

2-10 Explicit Call Transfer (ECT)

If you have one caller on hold and another active call, you may connect one call party to another call party and then leave the call. This is done by selecting the **Multiparty/Transfer** option from the in-call menu.

Accessories

There are various accessories for your mobile phone. You can select these options according to your personal communication requirements.



Standard Battery



Portable Handsfree

This connects to your phone, allowing handsfree operation.



Travel Adapter

This charger allows you to charge the battery while away from home or your office.



Cigar Lighter Adapter

You can operate the phone and trickle charge the phone's battery from your vehicle by using the cigarette lighter charger.



Neckstrap

Note

- Information and specification in this menu is subject to change without prior notice.
- Accessories may be different in different regions; please check with our regional service company or agent for further enquiries.

Care and Maintenance

When using this unit, basic safety precautions as below should be always followed.

- Do not touch the adapter with wet hands.
- Do not disassemble this unit. (Take it to a qualified service technician when repair work is required.)
- Away from electrical appliance such as a TV, radio or personal computer.
- The unit should be situated from heat sources such as radiators or cookers.
- Do not drop.
- Do not subject this unit to mechanical vibration or shock.
- The coating of the phone may be damaged if covered with wrap or vinyl wrapper.
- Use dry cloth to clean the exterior of the unit. (Do not use solvent such as benzene, thinner or alcohol.)
- Do not subject this unit to excessive smoke or dust.
- Do not keep the phone next to credit cards or transport tickets; it can be affect the information on the magnetic strips.
- Do not tap the screen with a sharp object; otherwise, it may damage the phone.
- Do not expose the phone to liquid or moisture.
- Use the accessories like an earphone cautiously. Do not touch the antenna unnecessarily.

■ Caring for the Battery

- You do not need to completely discharge the battery before recharging. Unlike other battery systems, there is no memory effect that could compromise the battery's performance.
- Use only LG batteries and chargers. LG chargers are designed to maximize the battery life.
- Do not disassemble or short-circuit the battery pack.
- Keep the metal contacts of the battery pack clean.
- Replace the battery when it no longer provides acceptable performance. The battery pack may be recharged hundreds of times until it needs replacing.
- Recharge the battery if it has not been used for a long time to maximize usability.
- Do not expose the battery charger to direct sunlight or use it in high humidity, such as the bathroom.
- Do not leave the battery in hot or cold places, this may deteriorate the battery performance.

Technical Data

General

Product name : G1500

System : GSM 900 / DCS 1800MHz

Ambient Temperatures

Max : +55°C

Min : -10°C

Declaration of Conformity



LG Electronics

This model complies with the essential requirements of Article 3 of the R&TTE 1999/5/EC Directive, if used for its intended use.

1. Health (Article 3.1.a of the R&TTE Directive)
2. Safety (Article 3.1.a of the R&TTE Directive)
3. Electromagnetic compatibility (Article 3.1.b of the R&TTE Directive)
4. Efficient use of the radio frequency spectrum (Article 3.2 of the R&TTE Directive)

I hereby declare under our sole responsibility that the product mentioned above to which this declaration relates complies with the above mentioned articles of the directive.

If available, write the contact person(s)

Mr. Jin Seog, Kim
LG Amsterdam Branch Office
Capronilaan 6, 1119 NR Schiphol-rijck,
The Netherlands
(Tel.) +31-20-655 7774

Mr. Ji Jong, Jeon
LG Electronics Inc. GSM Division
Emerald BD, 1042 Hogye-Dong, Dongan-Gu
Anyang-city, Kyuonki-Do
431-080, Korea

CE 0700

