

Top-level Schematic1

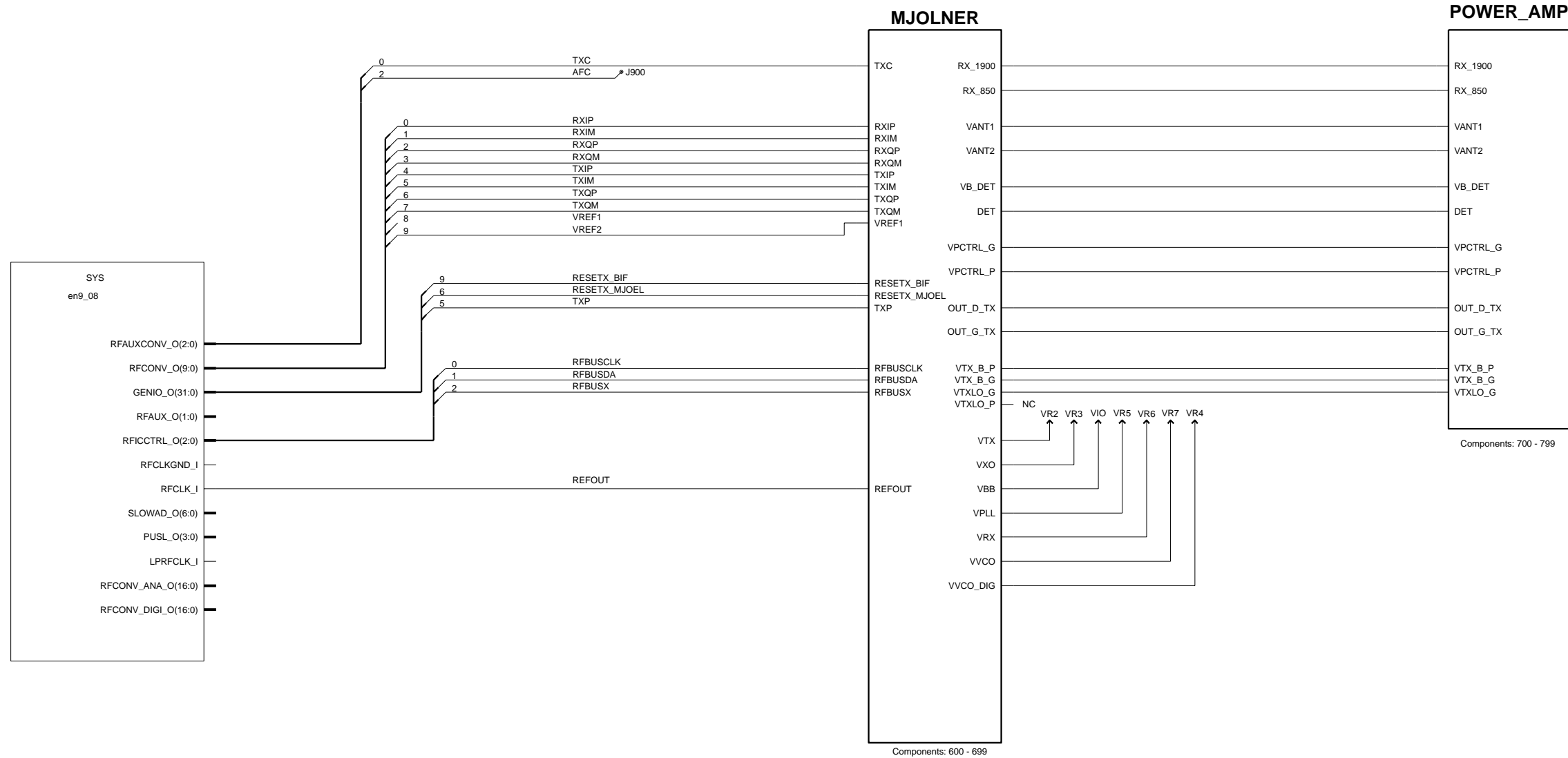

Shield Sheet

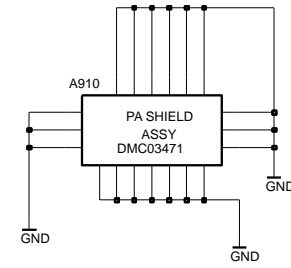
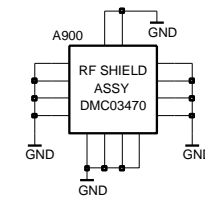
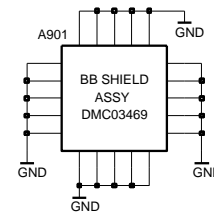
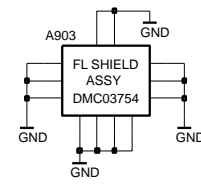
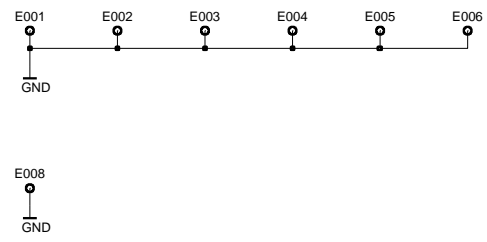

DCT4 Common Baseband

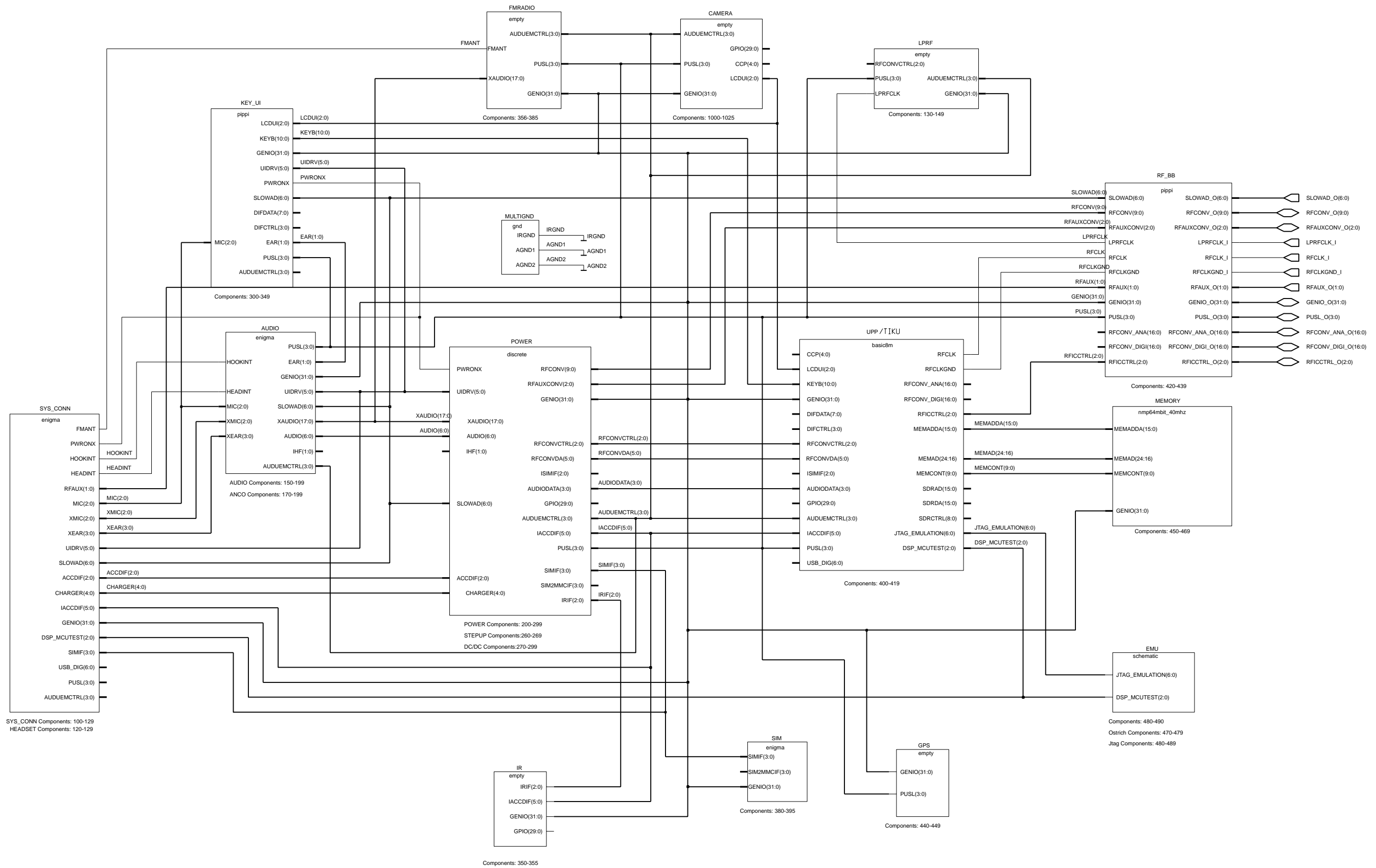

DC/DC Converter

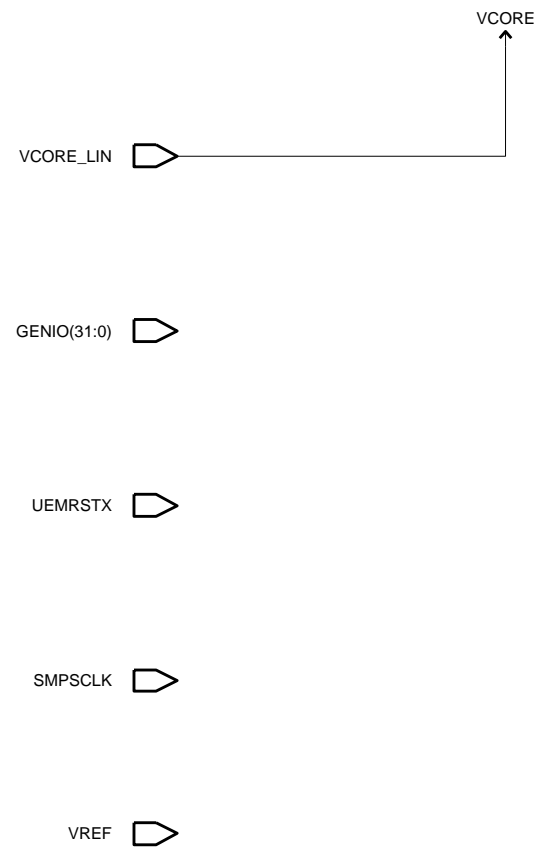

DCT4 Power Supply

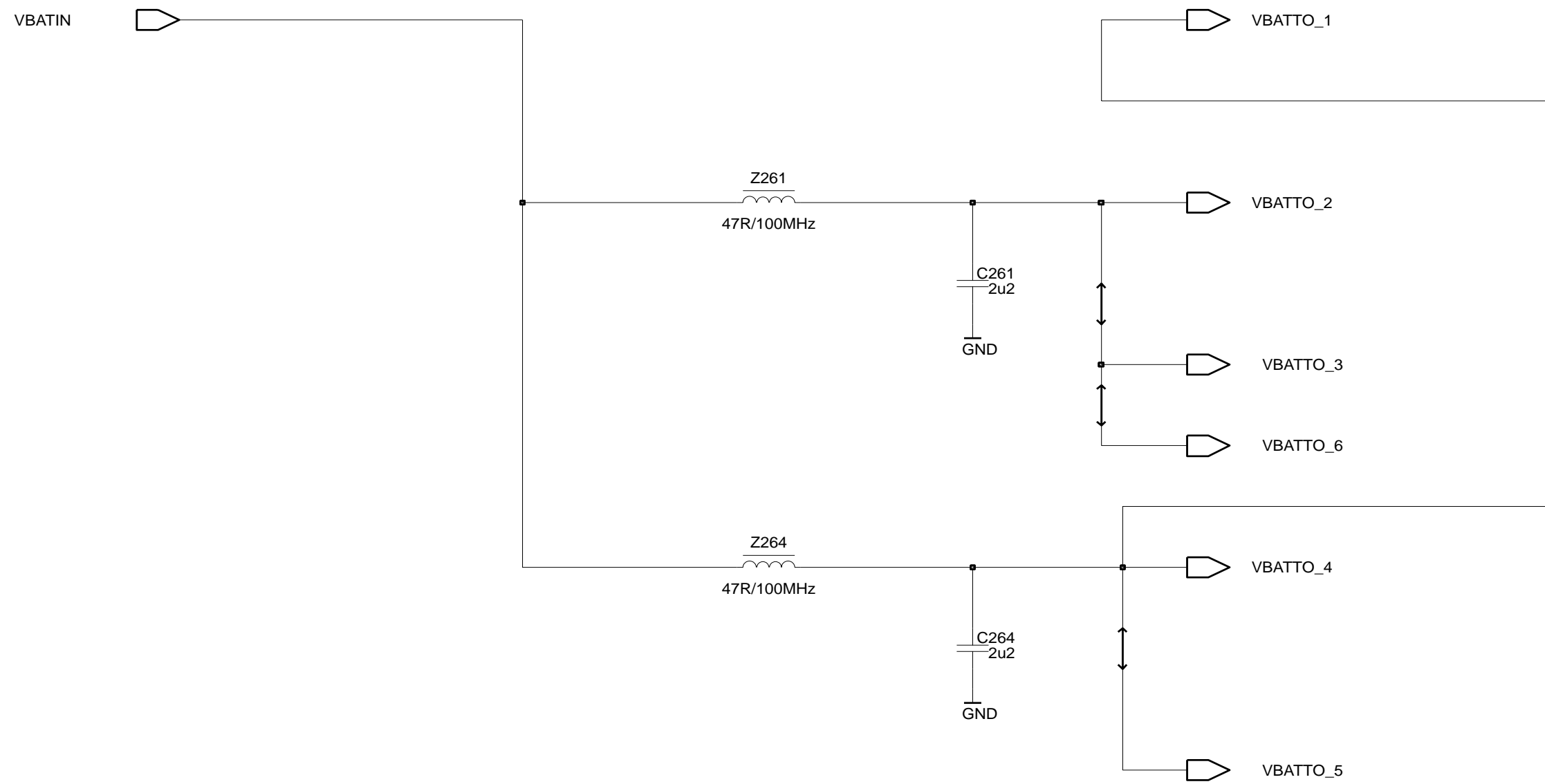

DCT4 Common Baseband

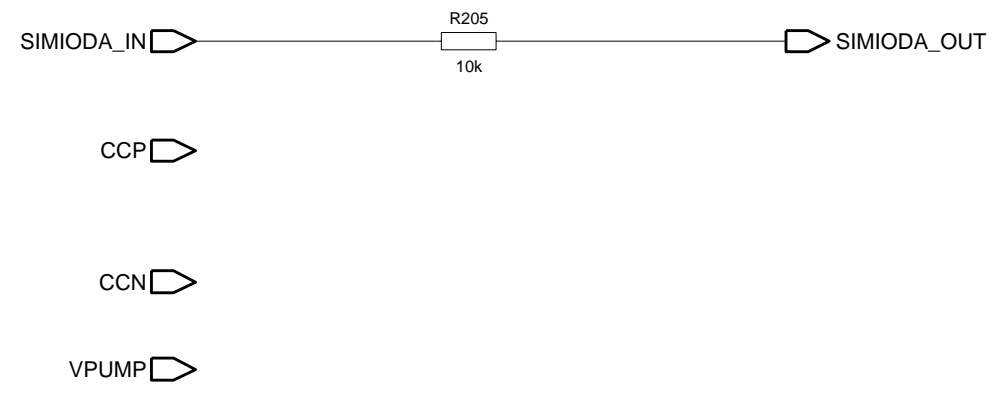

System Connector

For After Sales

X101
 Janette Battery I/F

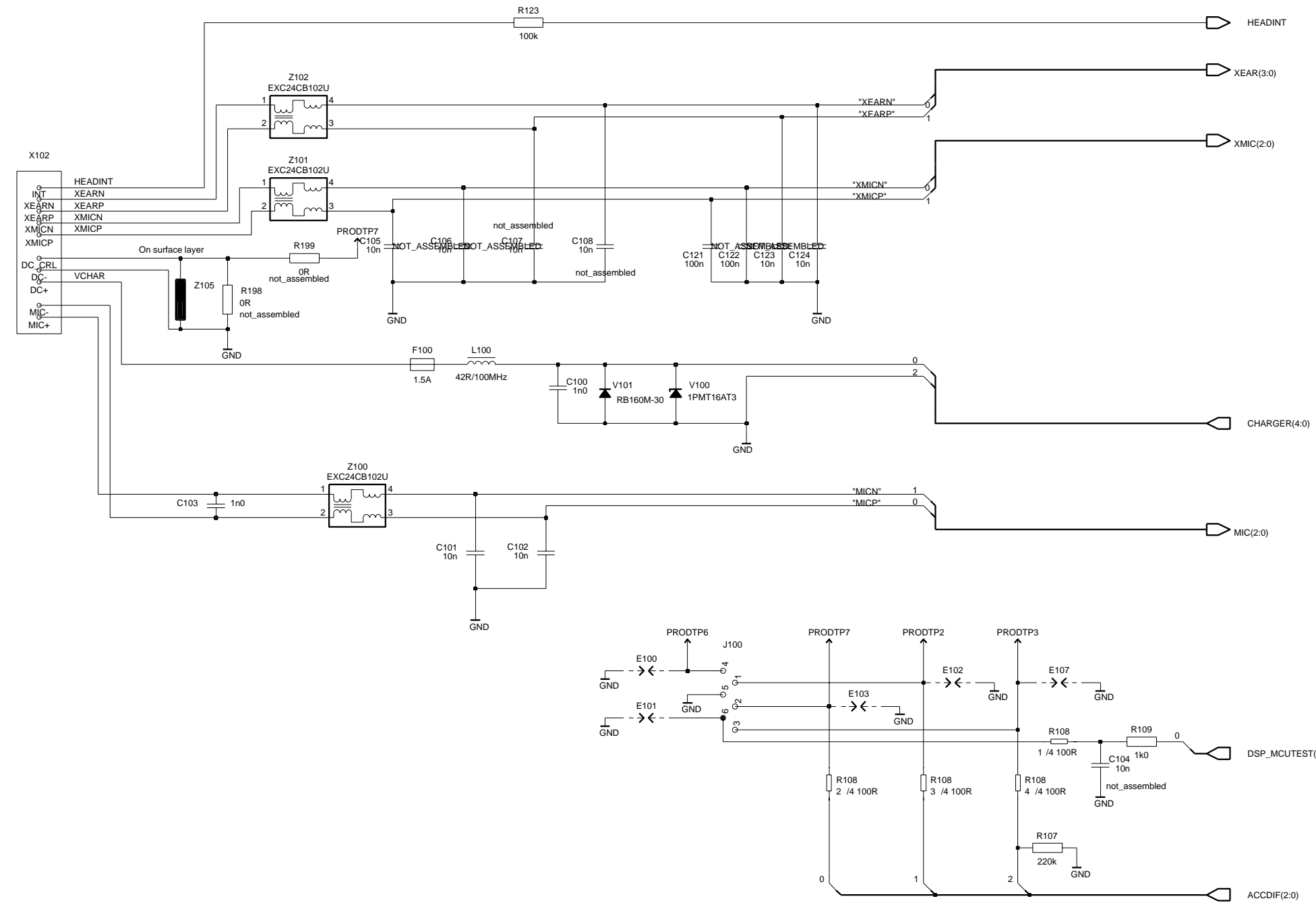
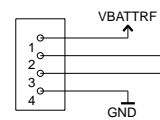

- UIDRV(5:0)
- IACCDIF(5:0)
- RFAUX(1:0)
- PWRONX
- SIMIF(3:0)
- HOOKINT
- GENIO(31:0)
- FMANT
- USB_DIG(6:0)
- PUSL(3:0)
- AUDUEMCTRL(3:0)

Test and Emulator Interface



Connector-based Ostrich Test Interface

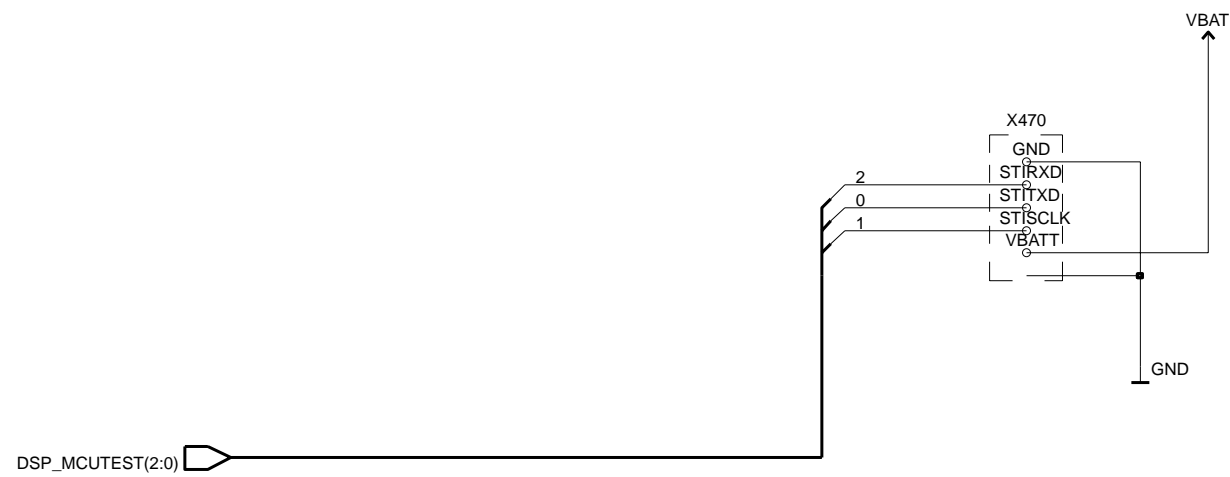

User Interface Clover Key Targets

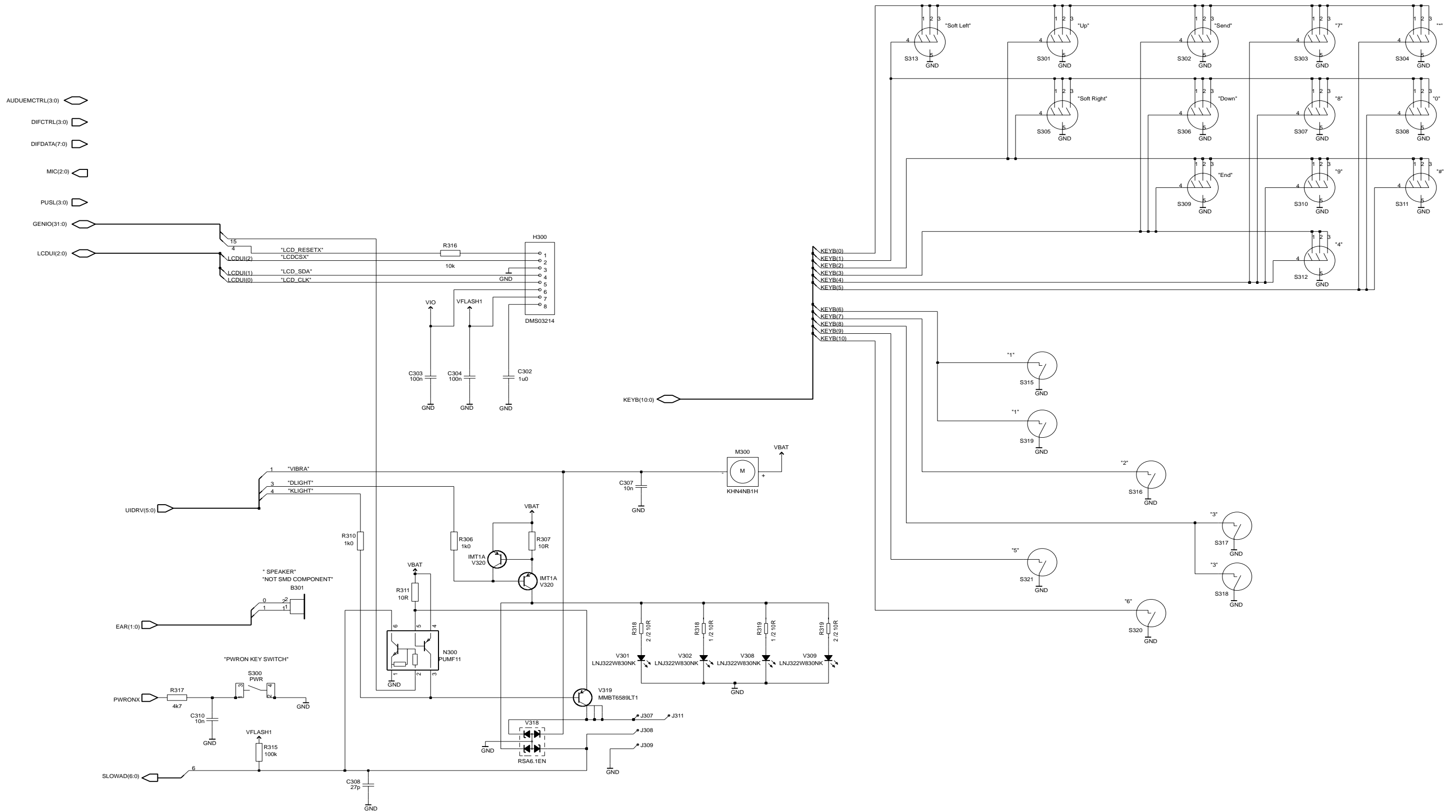

UPP 8M Implementation

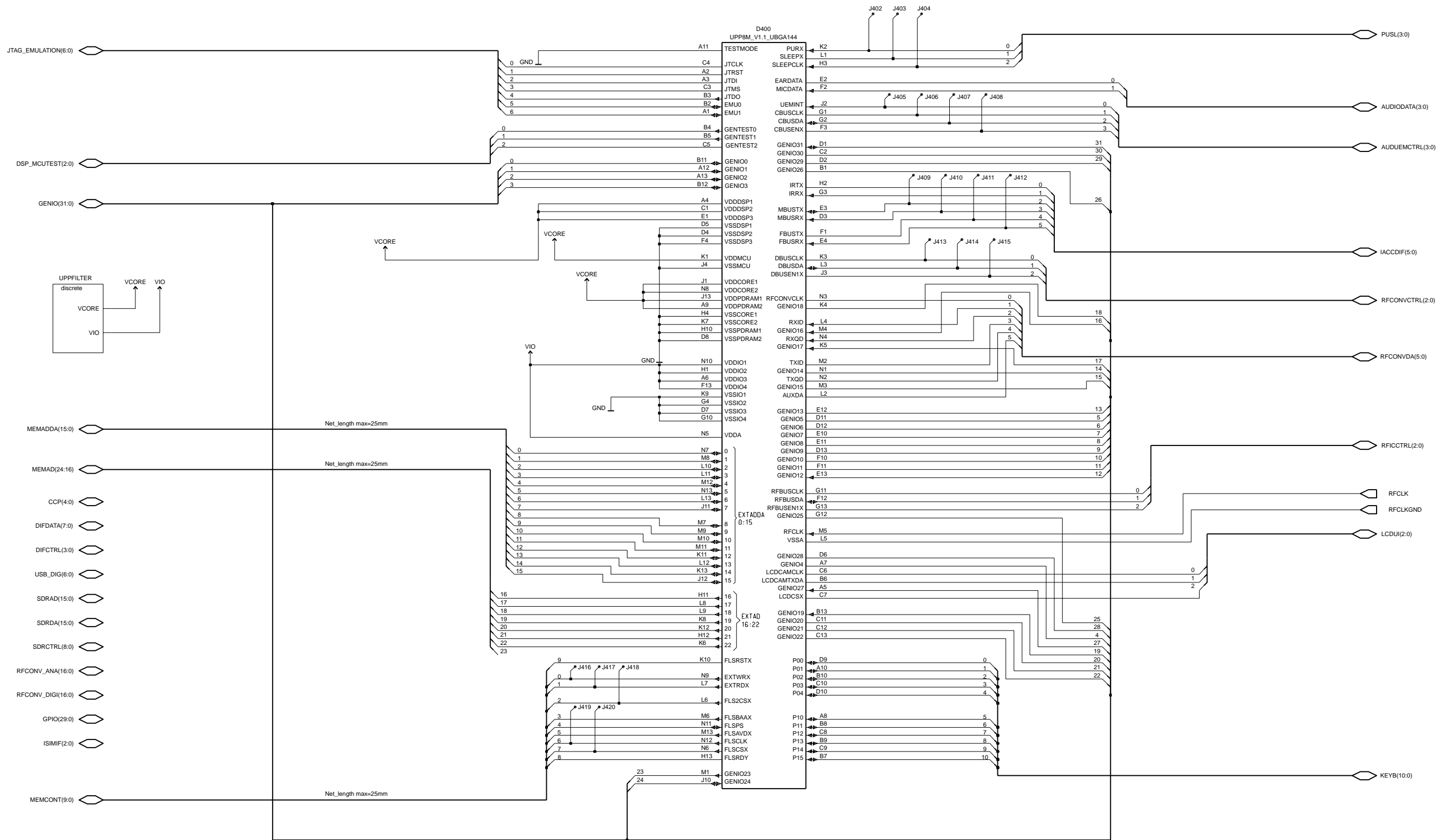

Discrete Decoupling Capacitors for UPP

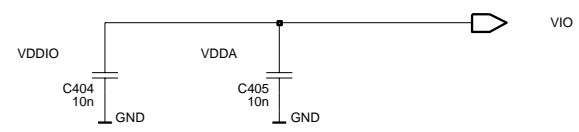
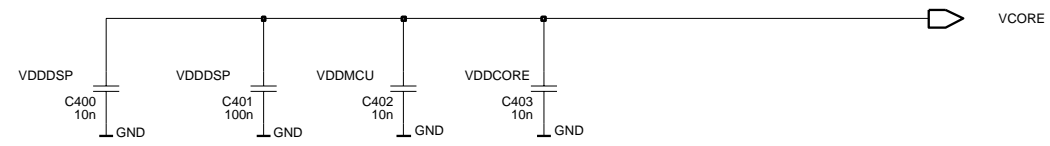

Flash Memory 64 Mbit

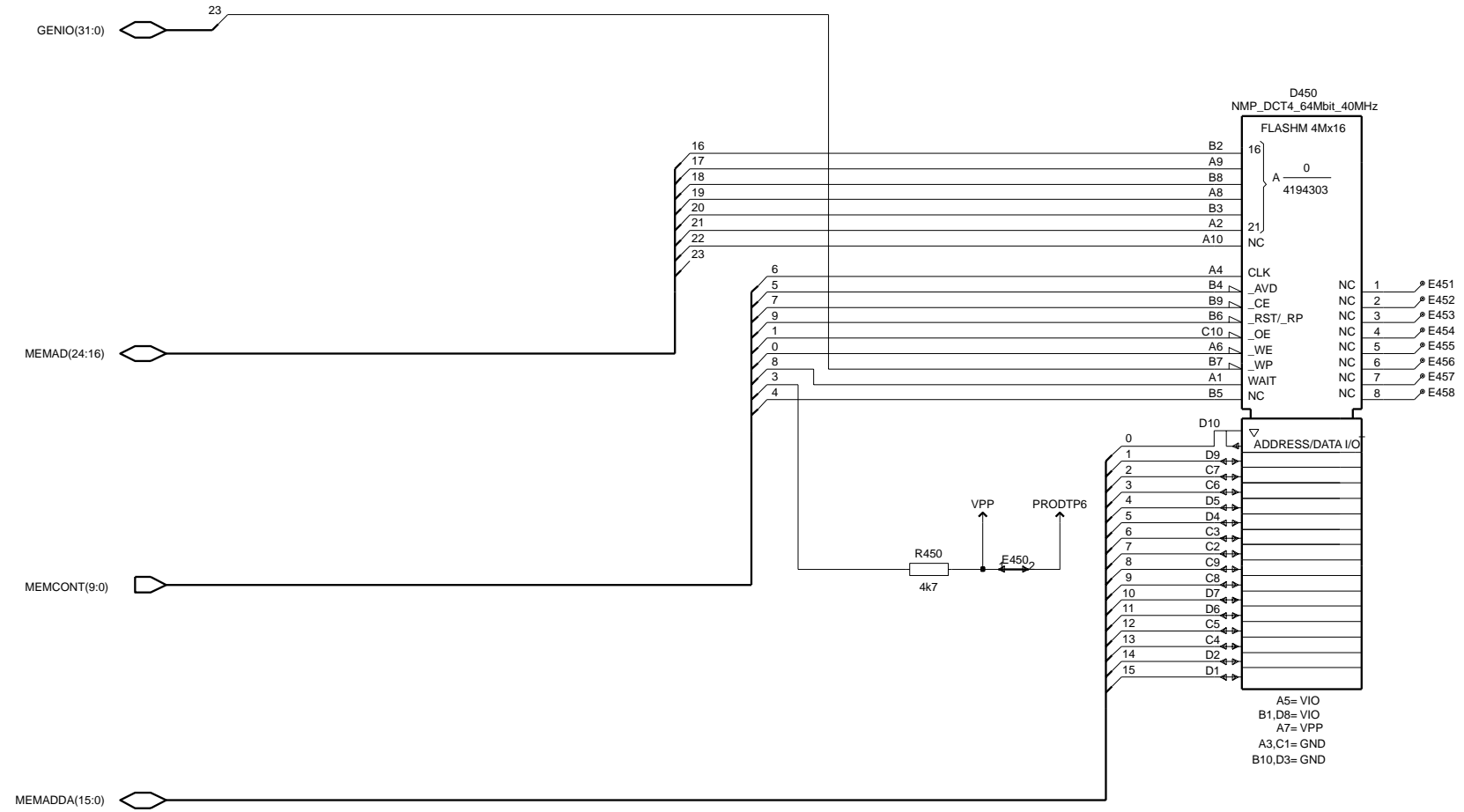
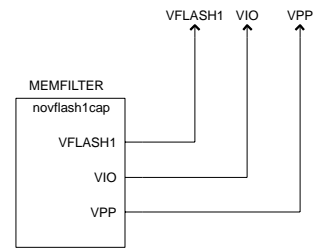



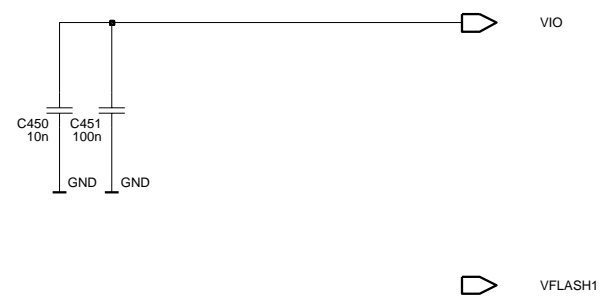

Discrete Capacitors for Memory Without VFlash

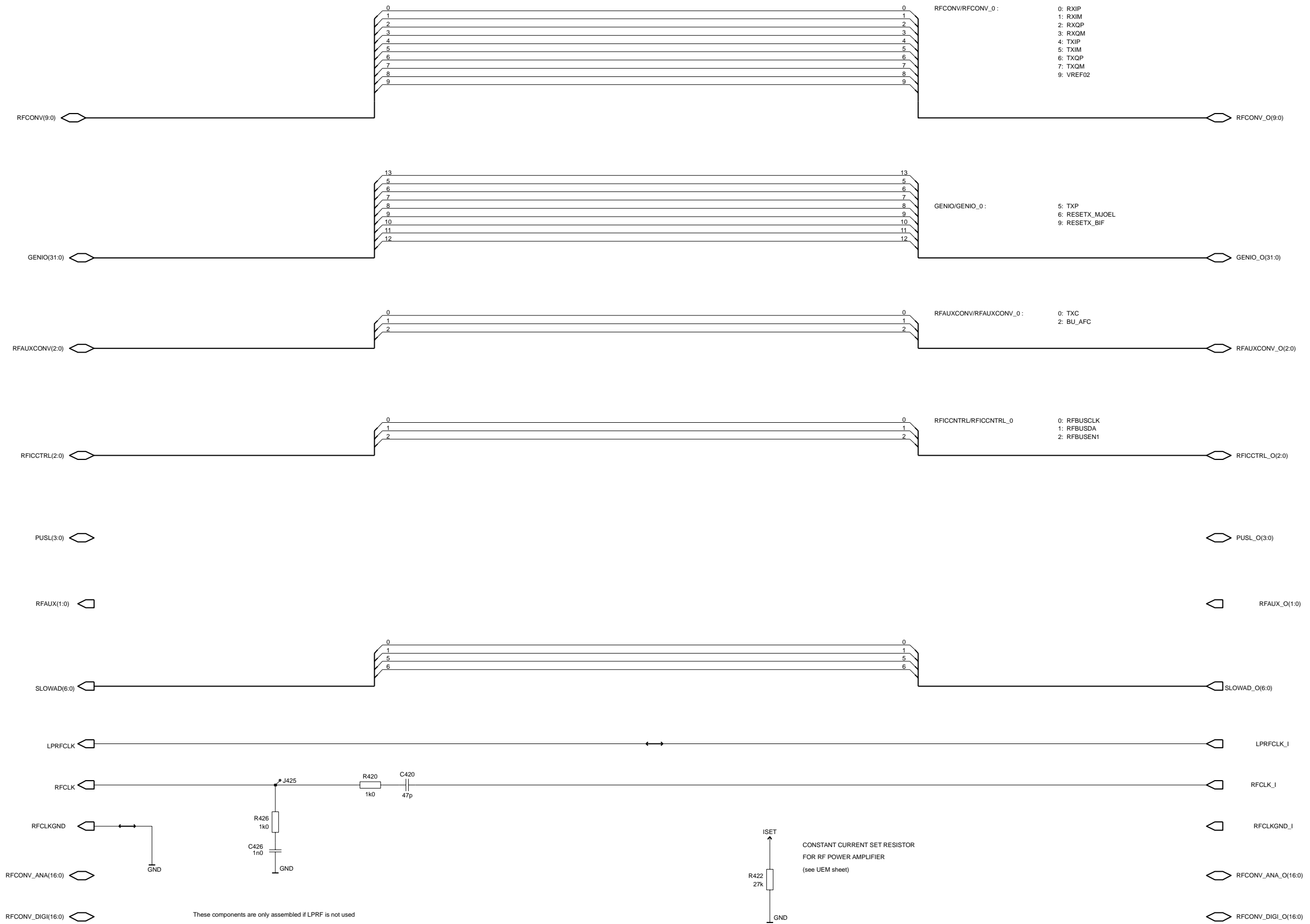

RF/BB Interface



Audio Interface

-  PUSL(3:0)
-  UIDRV(5:0)
-  HOOKINT
-  AUDUEMCTRL(3:0)
-  IHF(1:0)

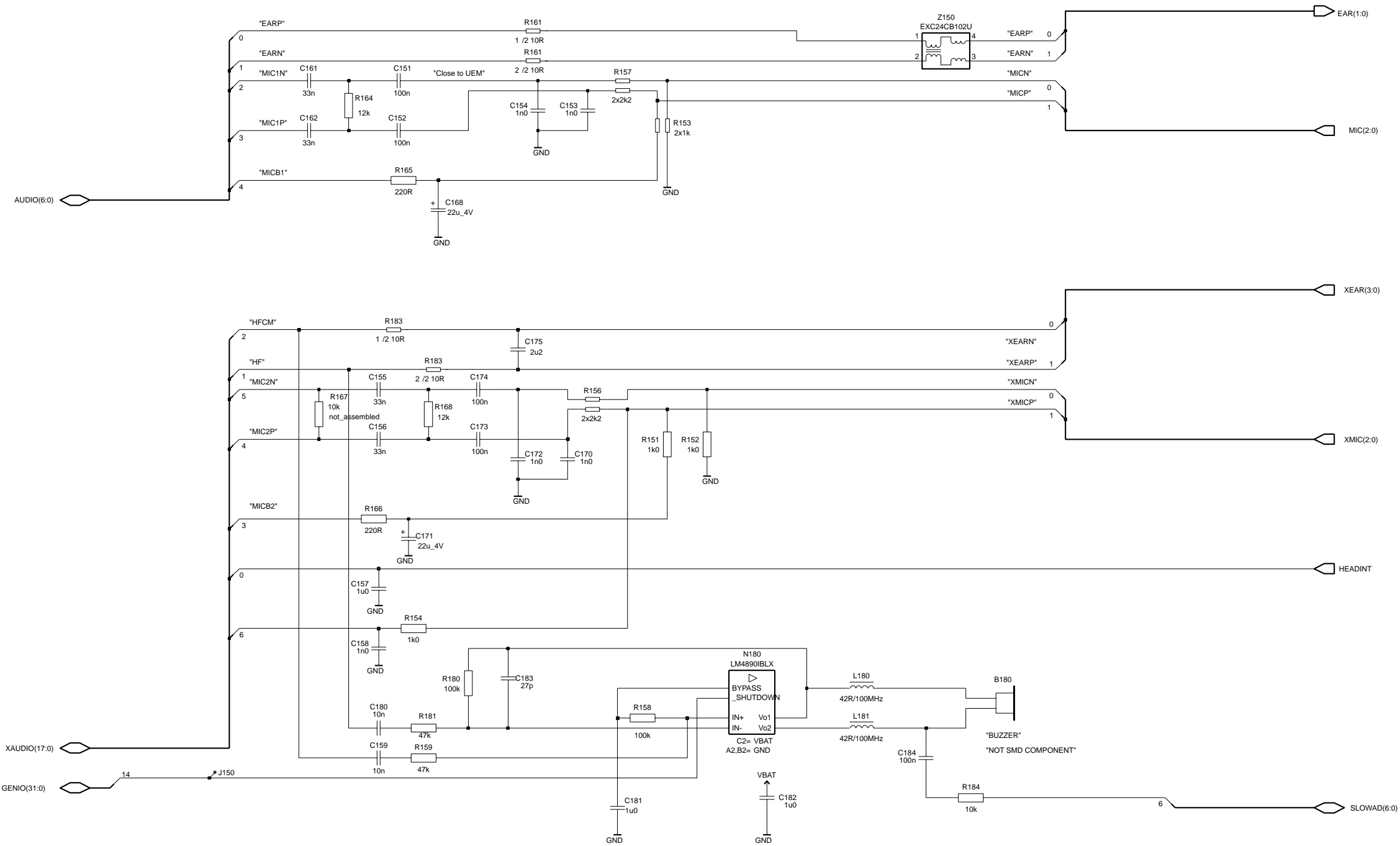

SIM Interface

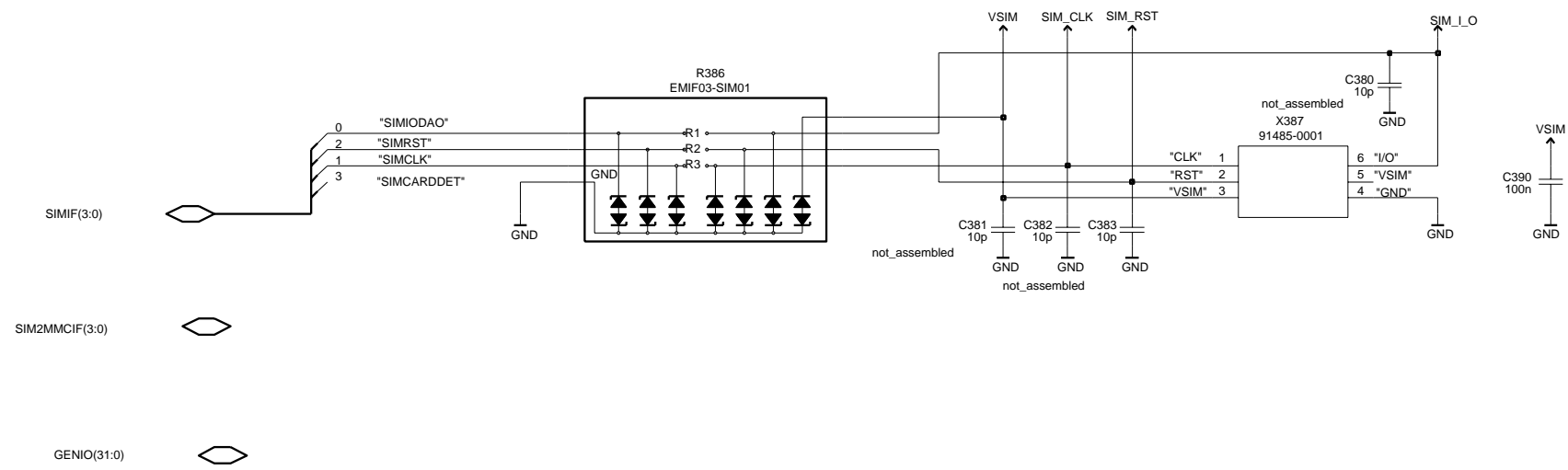

Power Amplifier

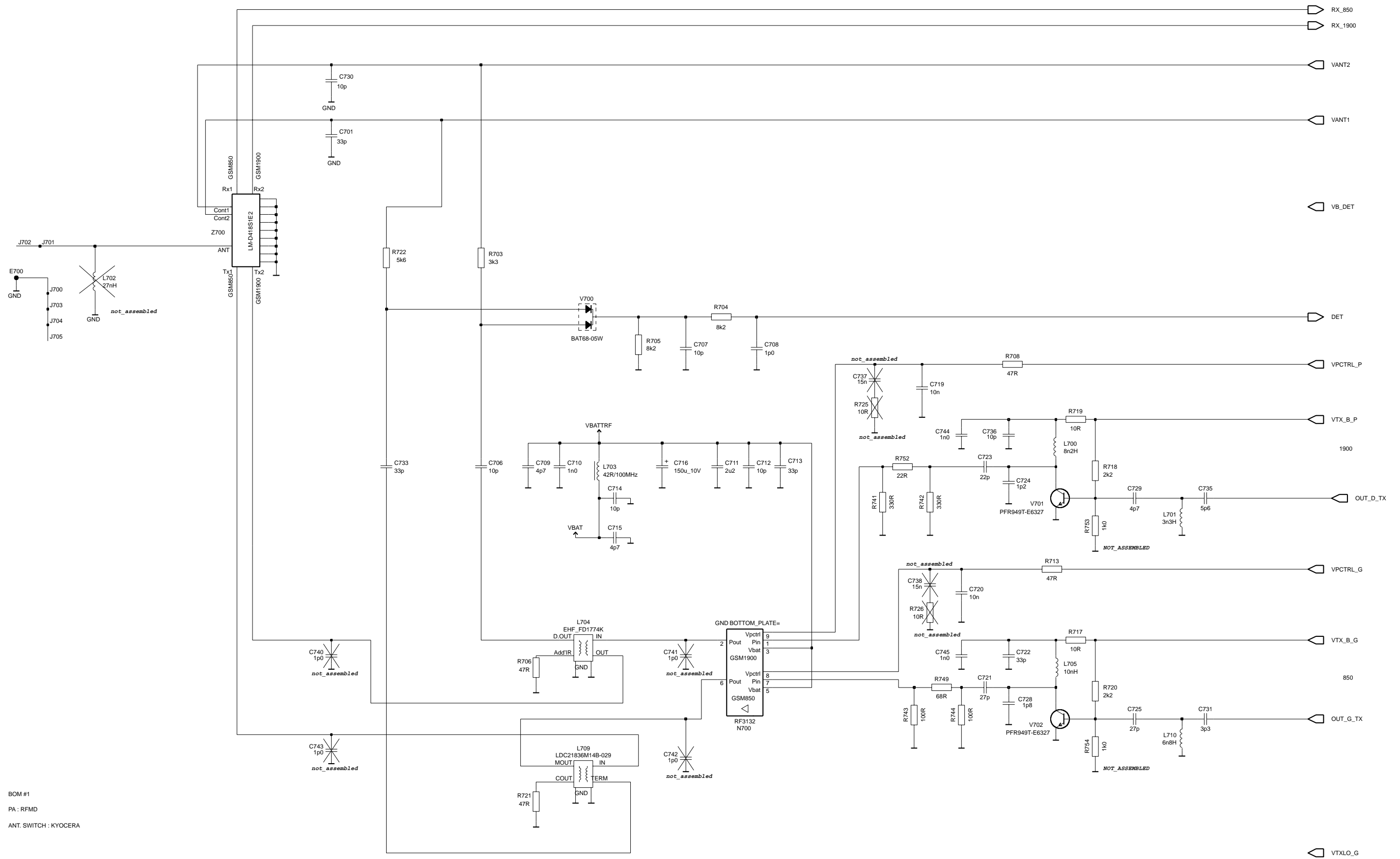

Mjoelner

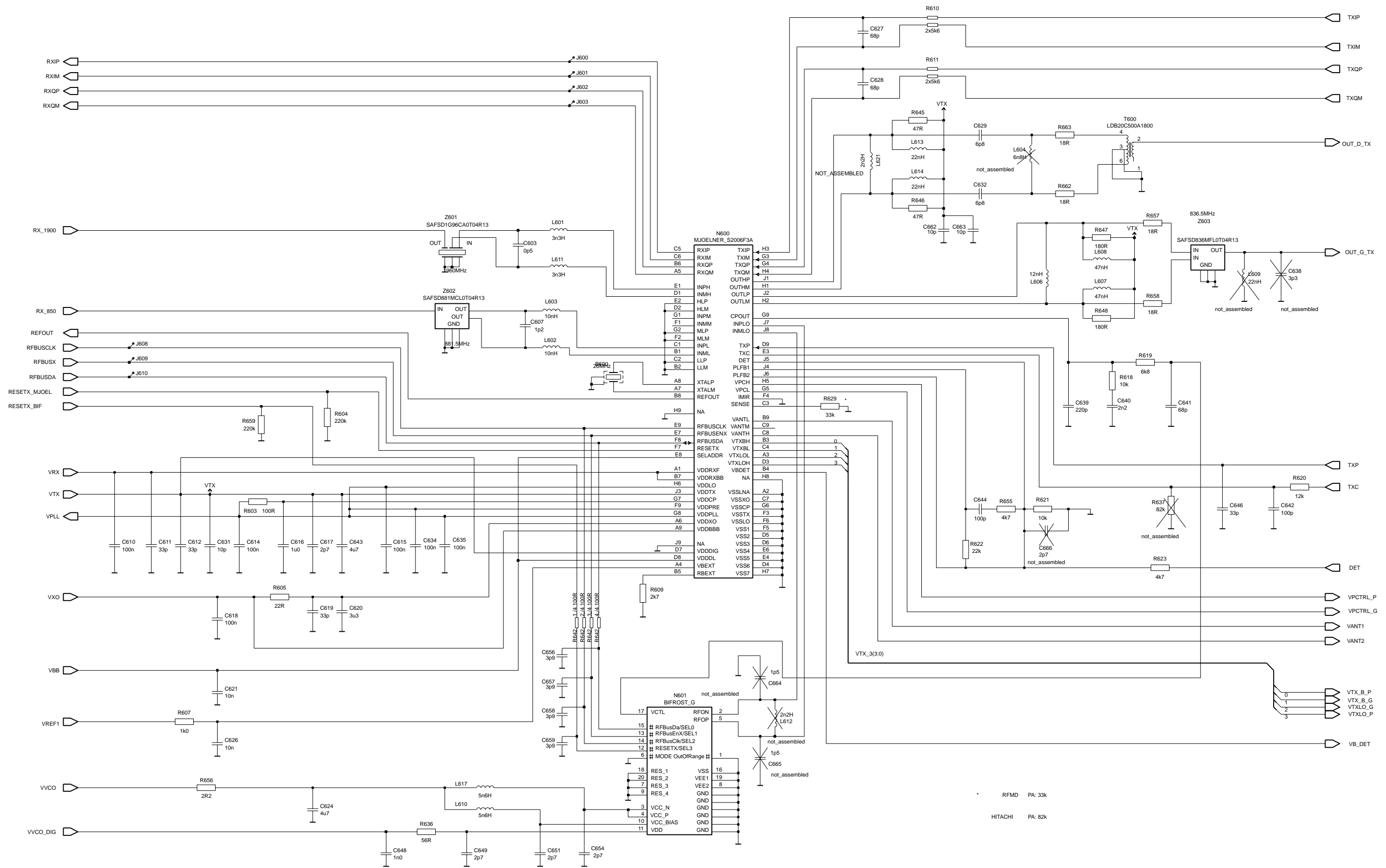

R603 - 663
 C600 - 666
 L600 - 621
 Z600 - 603
 J600 - 610
 N600 - 601
 B600
 T600

RFMD PA: 33k
 HITACHI PA: 82k

