

RF

MAD

MAD  
SYSCON  
COBBA

MAD

MAD

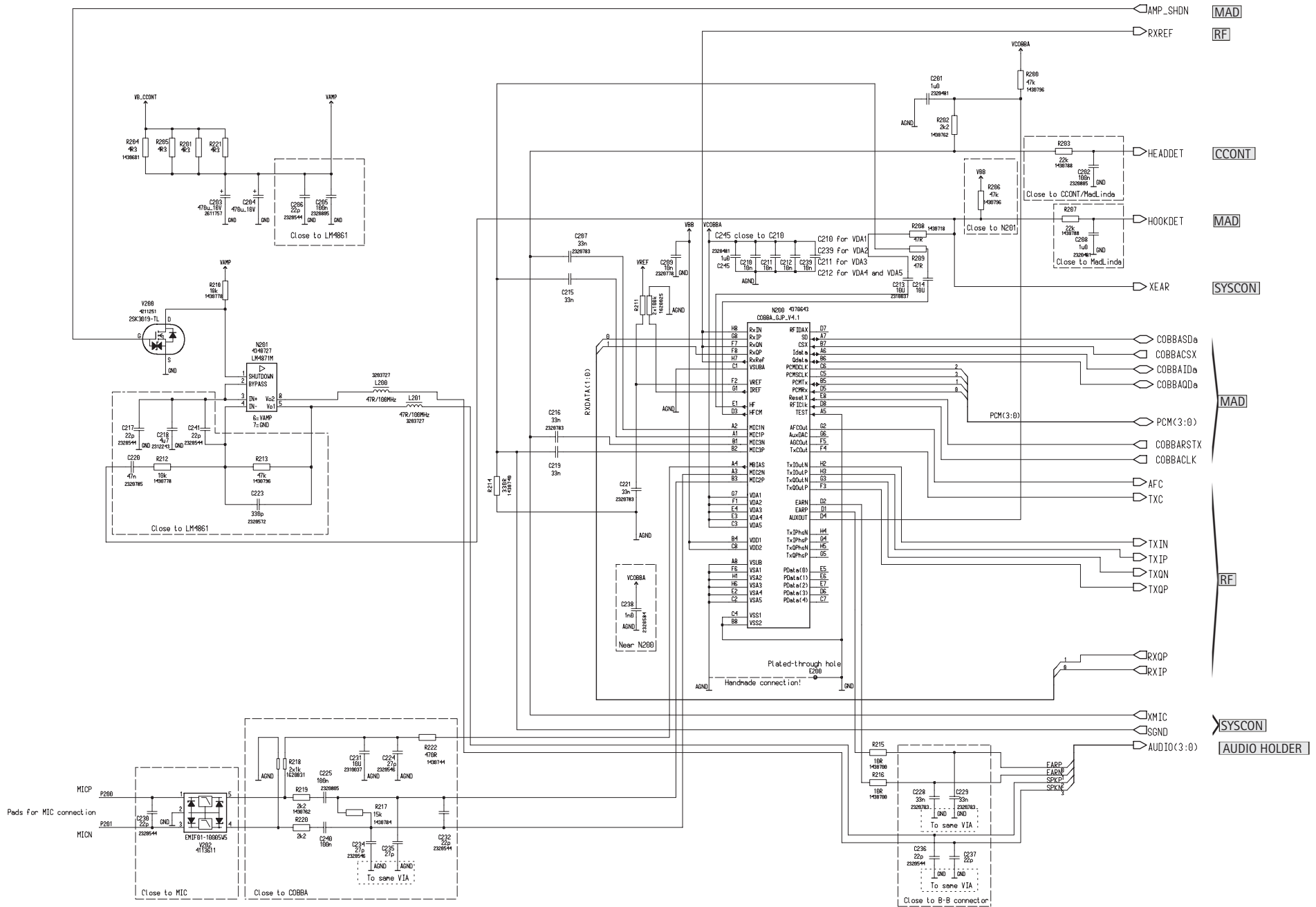

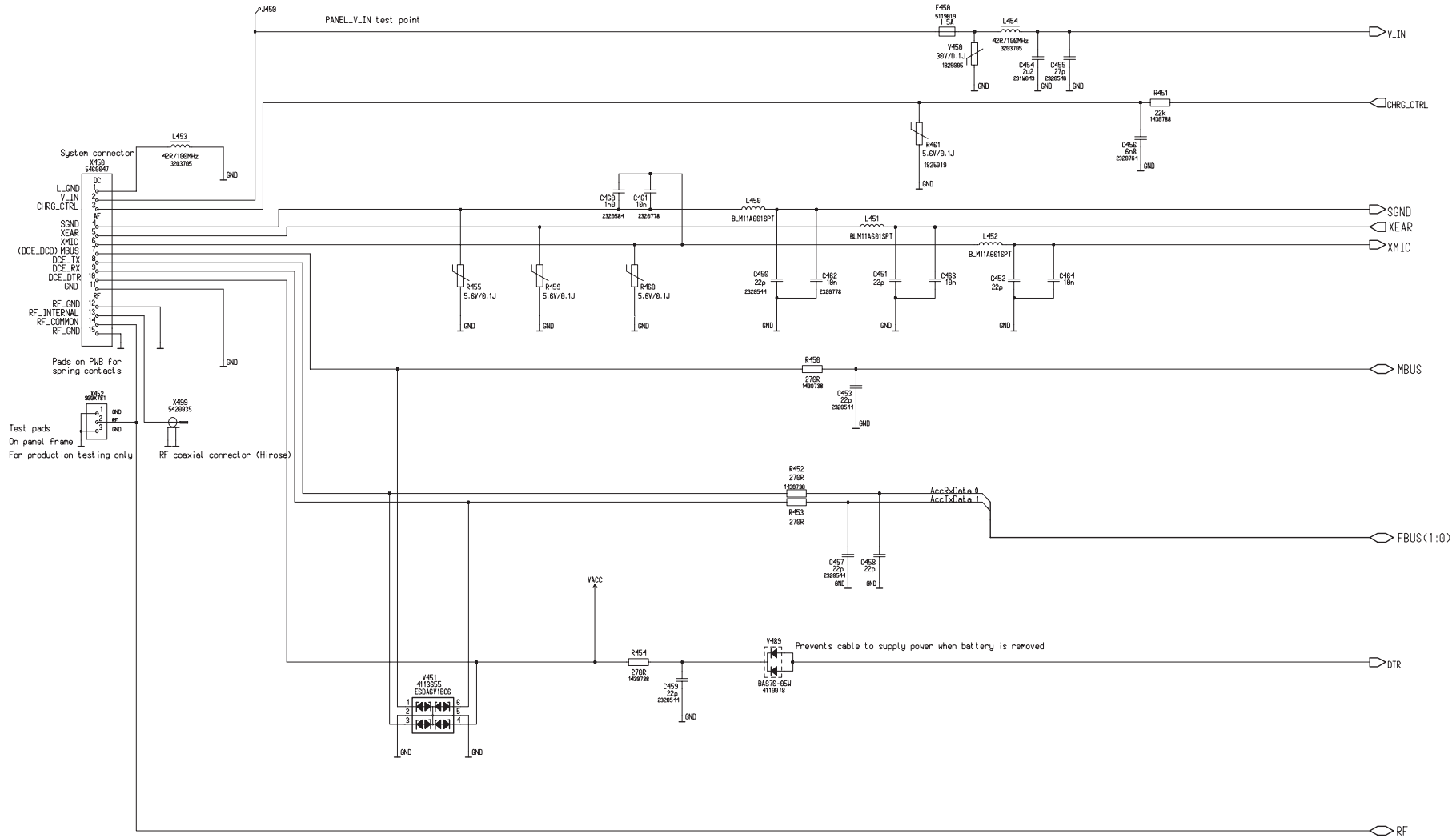

CONT

COBBA

MAD

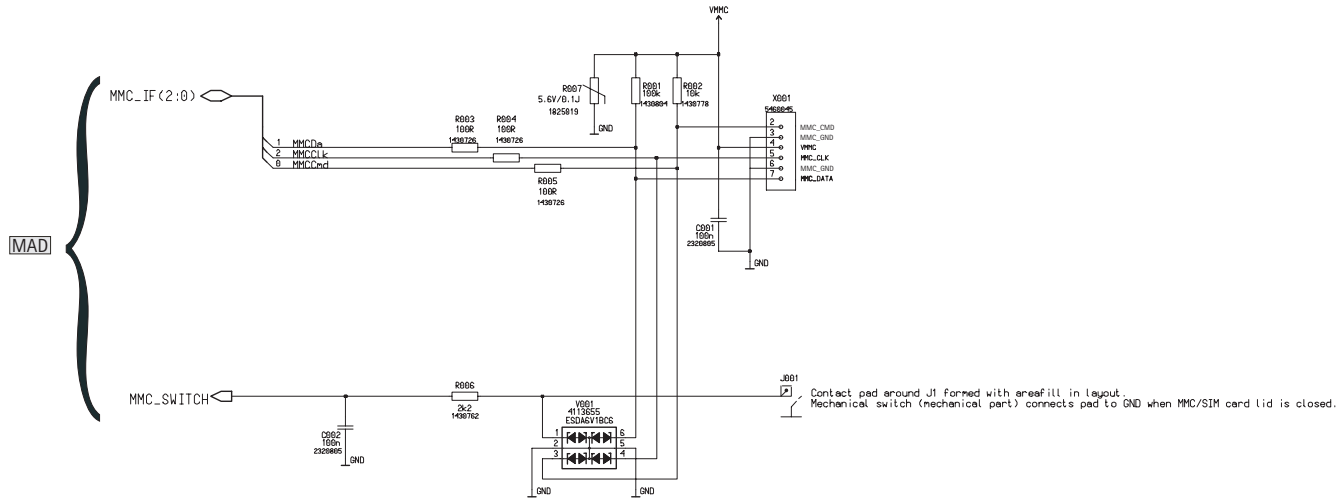
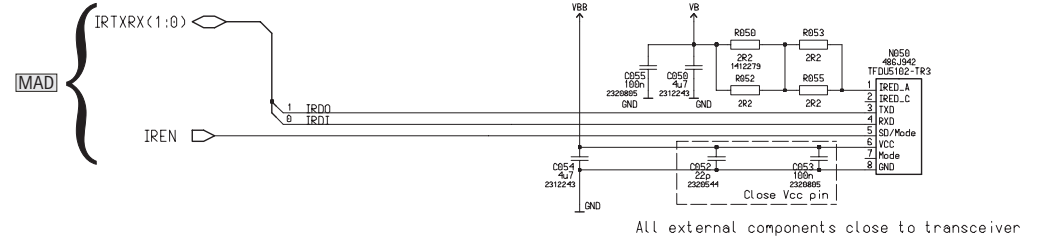
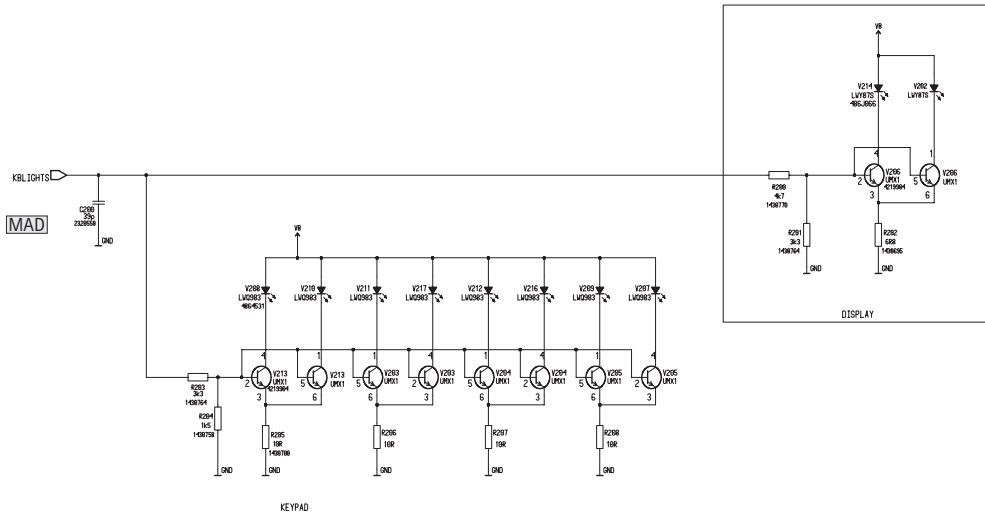

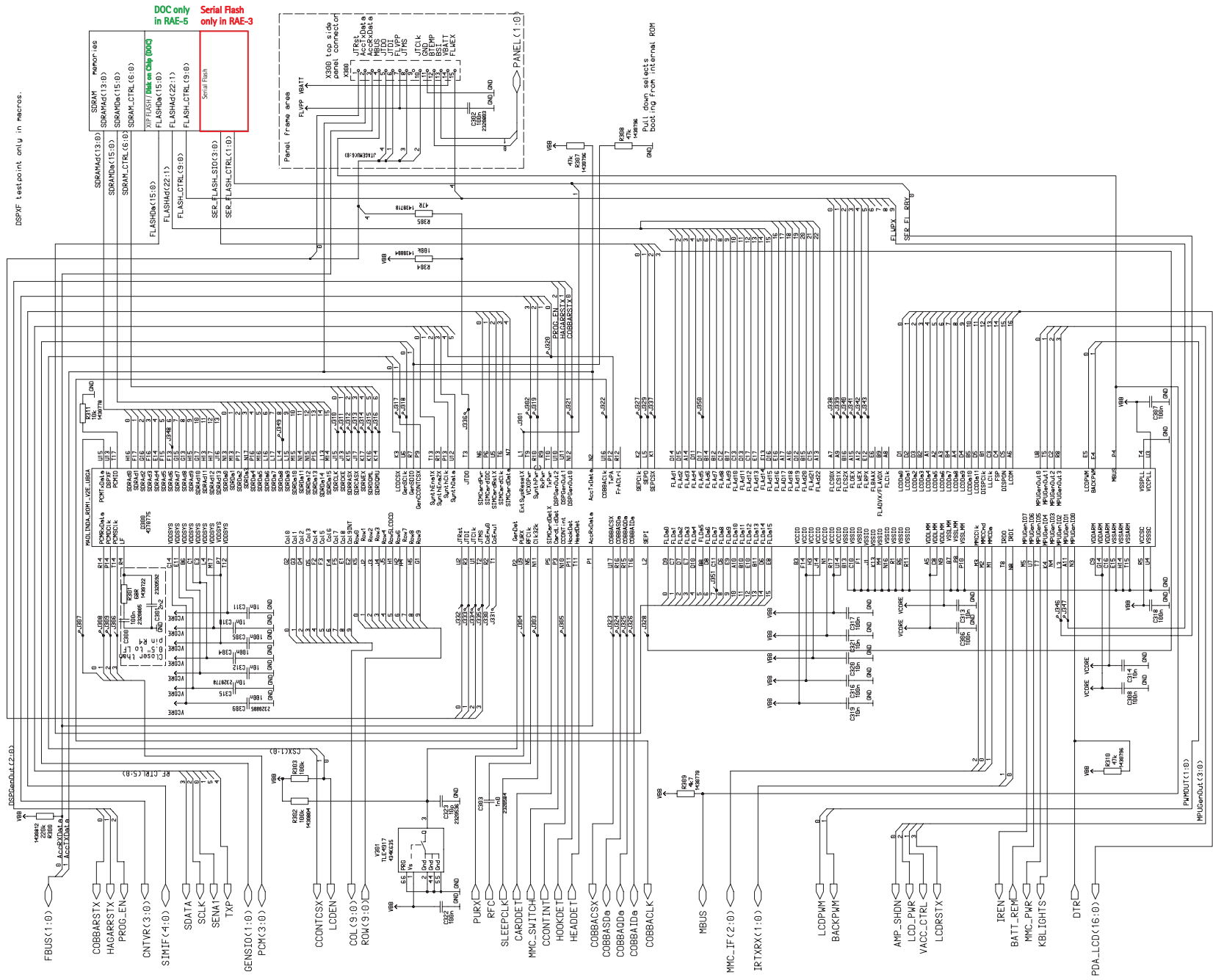

DSP\_XE testpoint only in macros.

**DOC only in RAE-5**     **Serial Flash only in RAE-3**



Pushing boot pin down selects booting from internal ROM

BoardSerial(2:0)

PMICOut(3:0)

PMICOut(3:0)

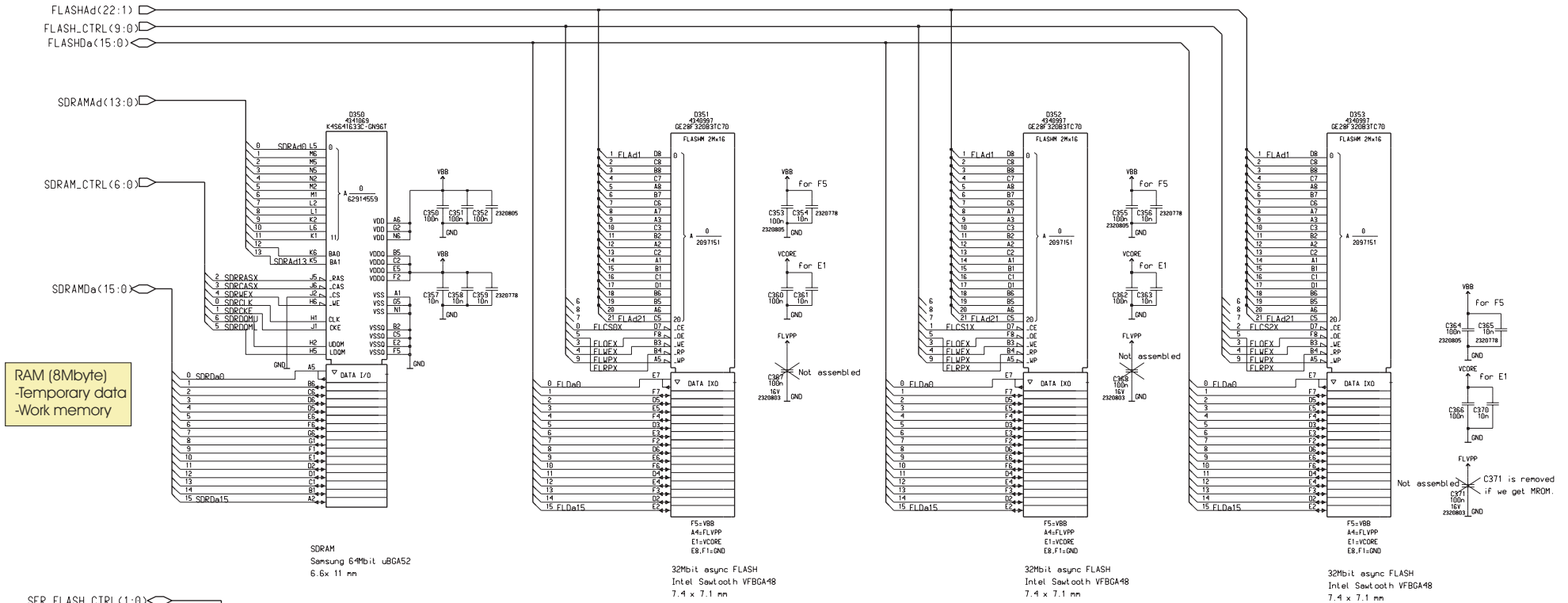

XIP (execute in place) 3x 4Mbyte  
 -Main program memory (CMT & PDA software)  
 -D353 also includes emulated EEPROM

Linda HWID K31 10  
KL8\_05 memories

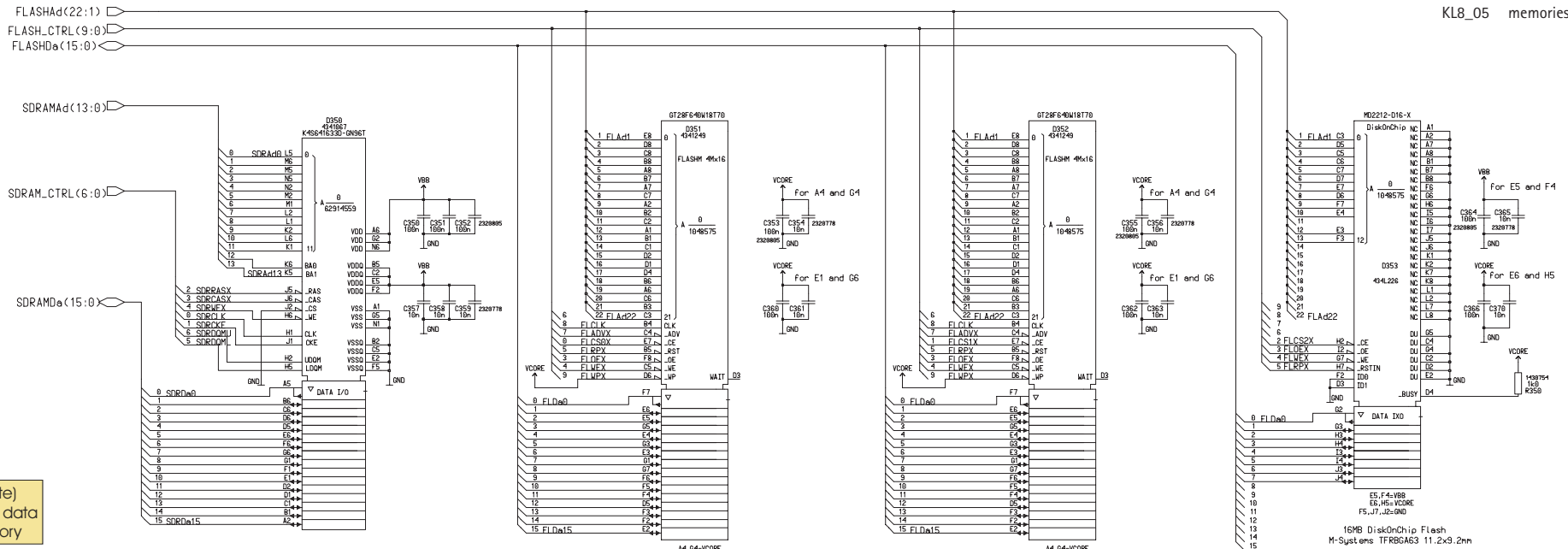

RAM (8Mbyte)  
-Temporary data  
-Work memory

DOC (Disk on Chip) 16Mbyte  
Partly for user data/application

XIP (execute in place) 2x 8Mbyte  
-Main program memory (CMT & PDA software)  
-D352 also includes emulated EEPROM

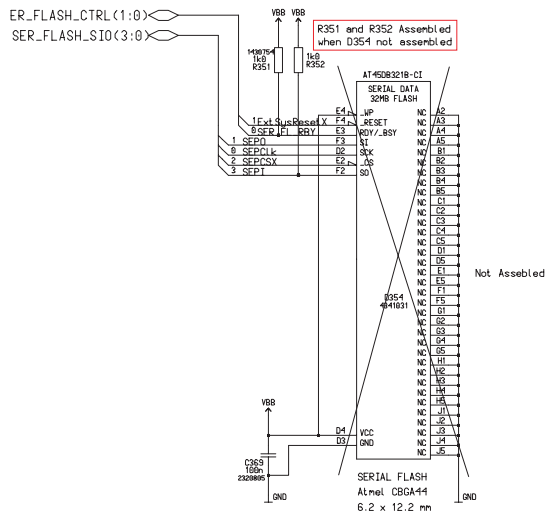

Used prefixes: D, C  
Component refs. 350-399

### Flyback regulator

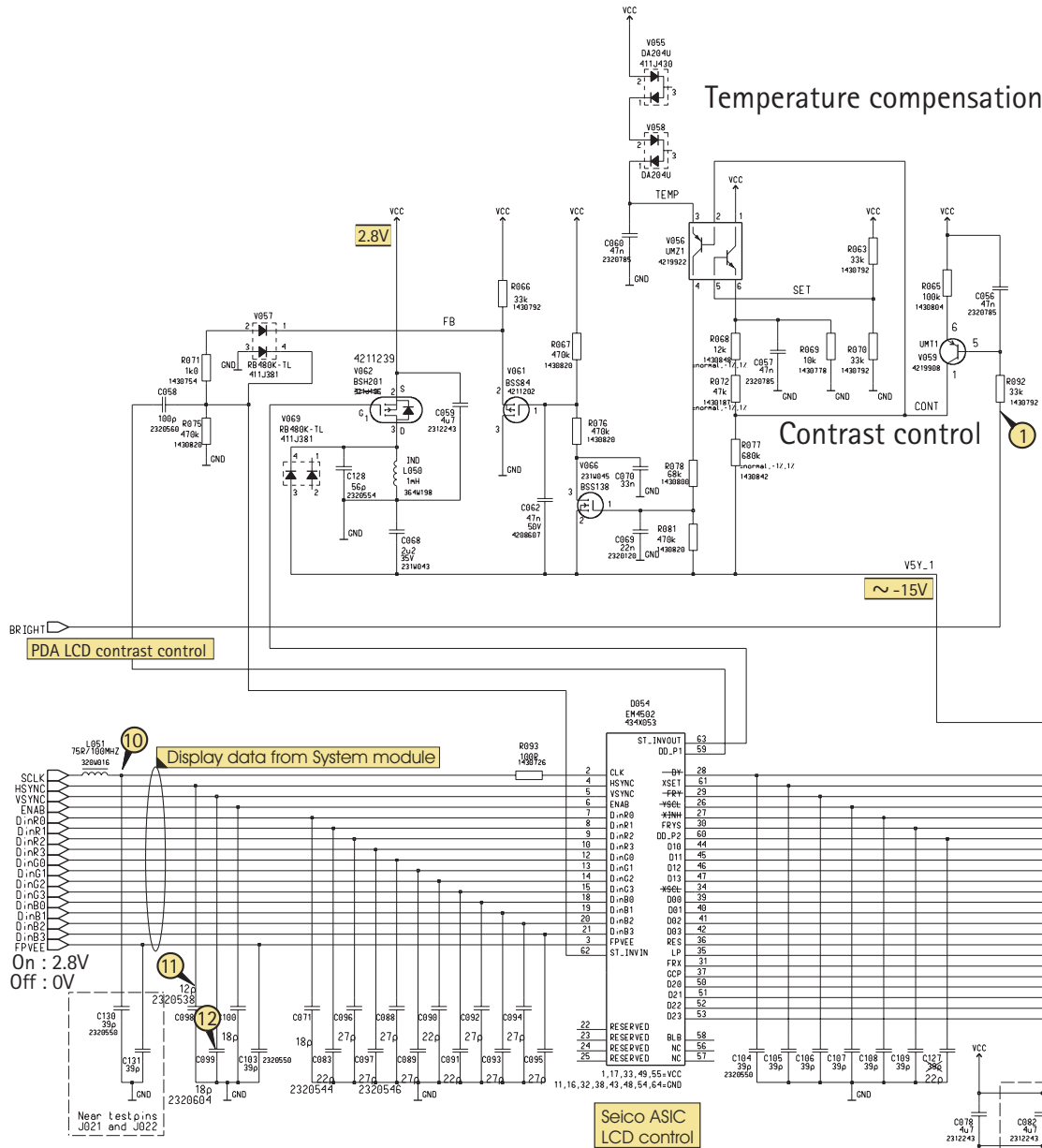

### Swing mode regulator

#### Level shift for vertical logic signals

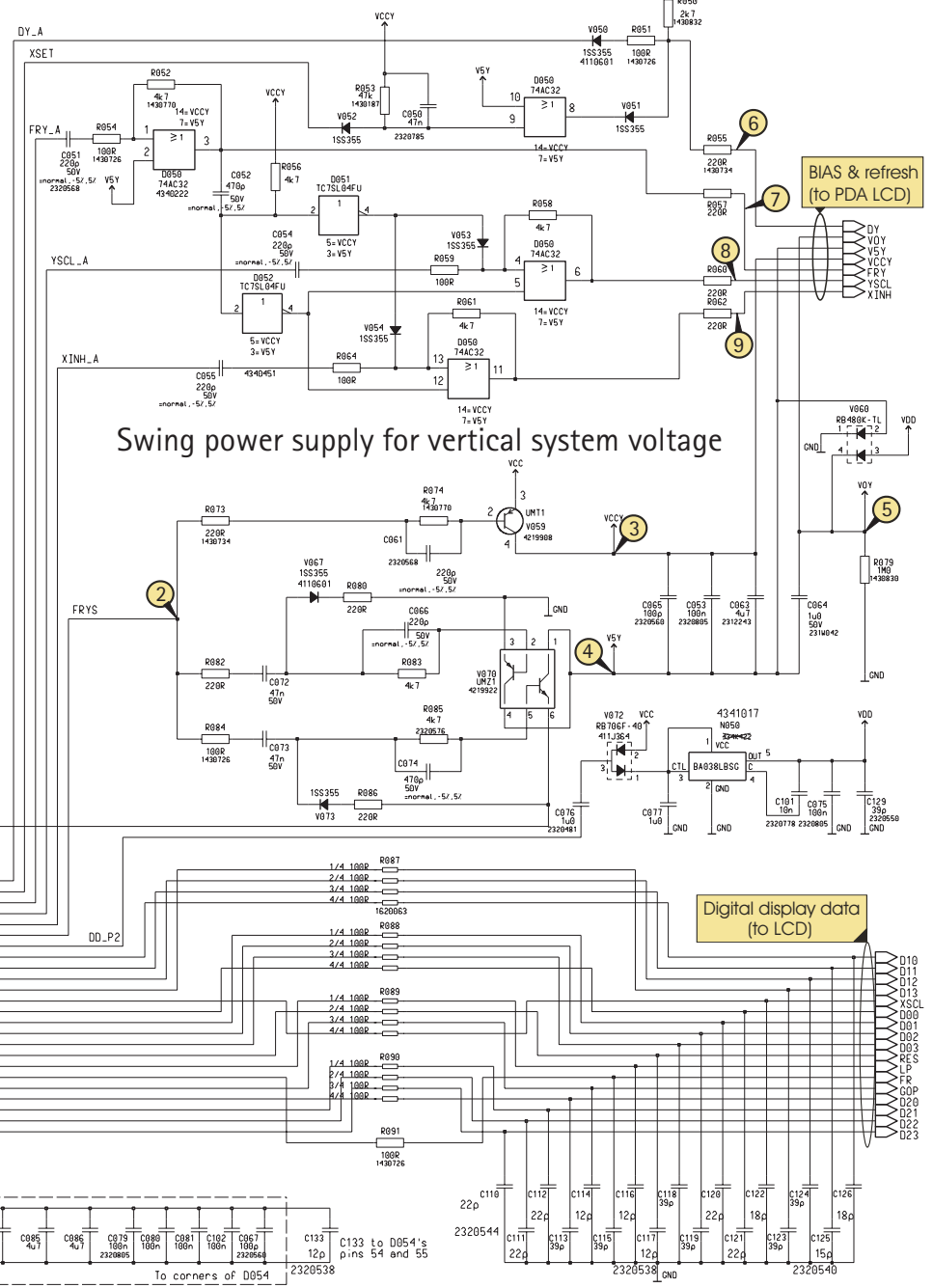



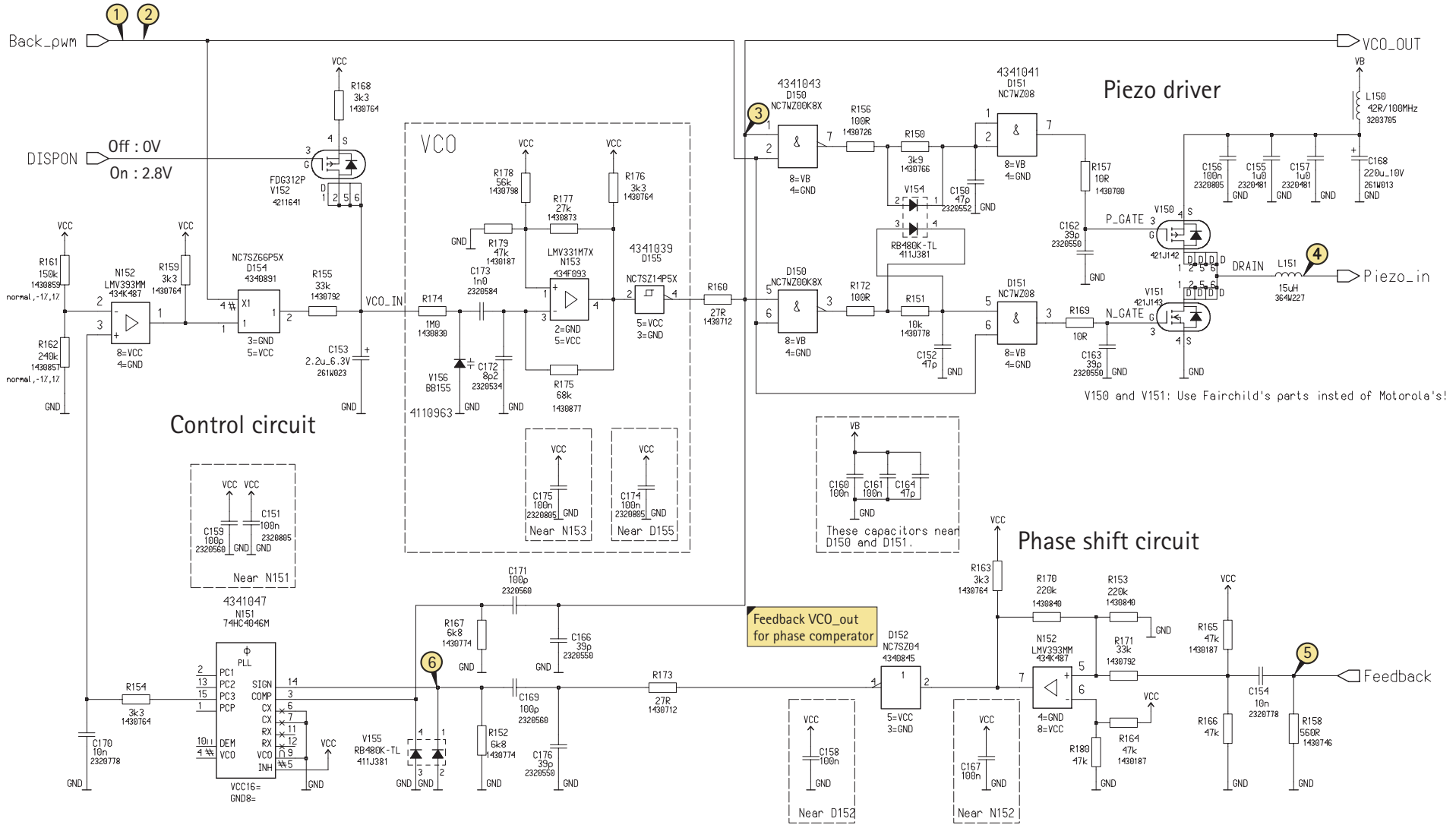

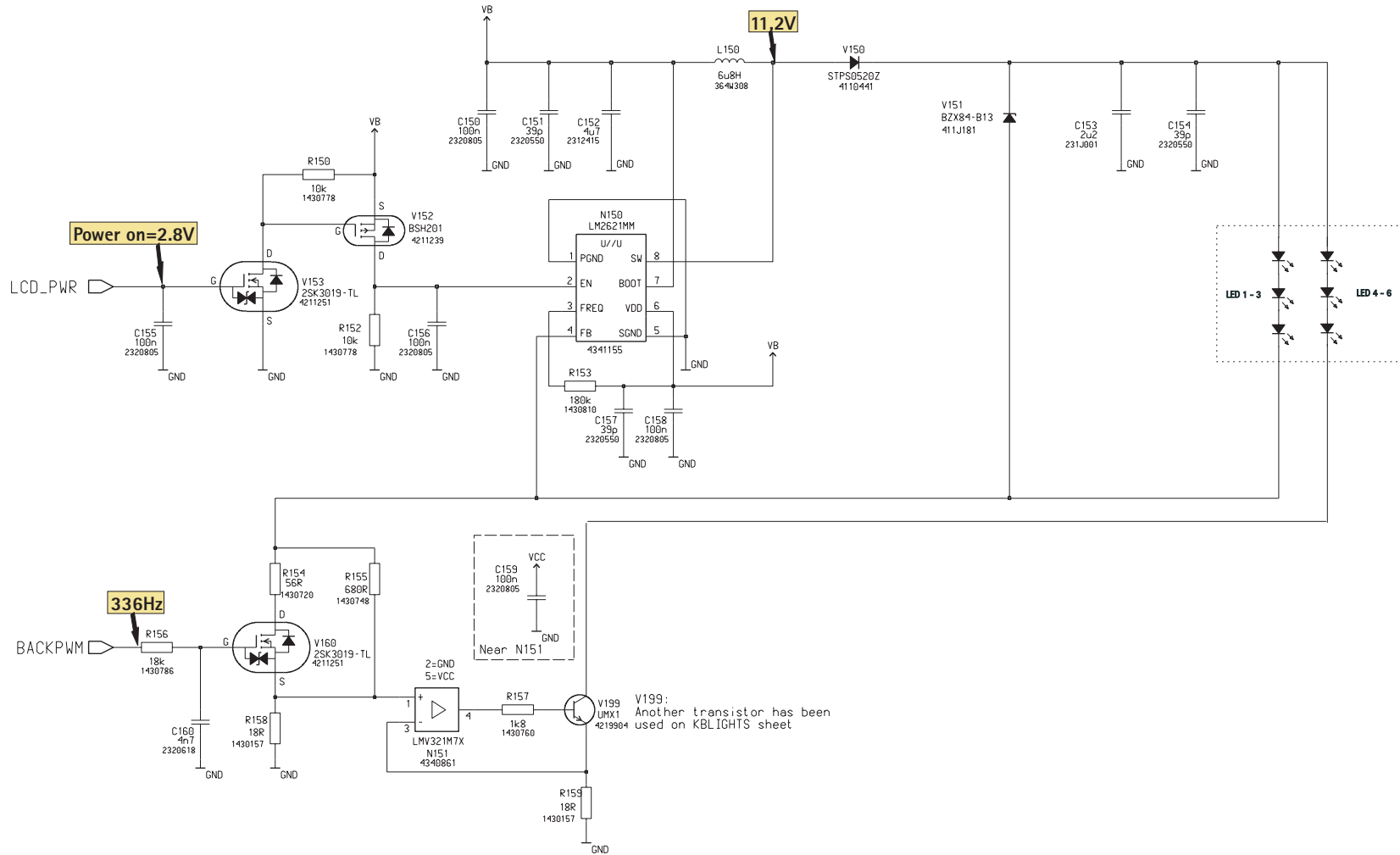

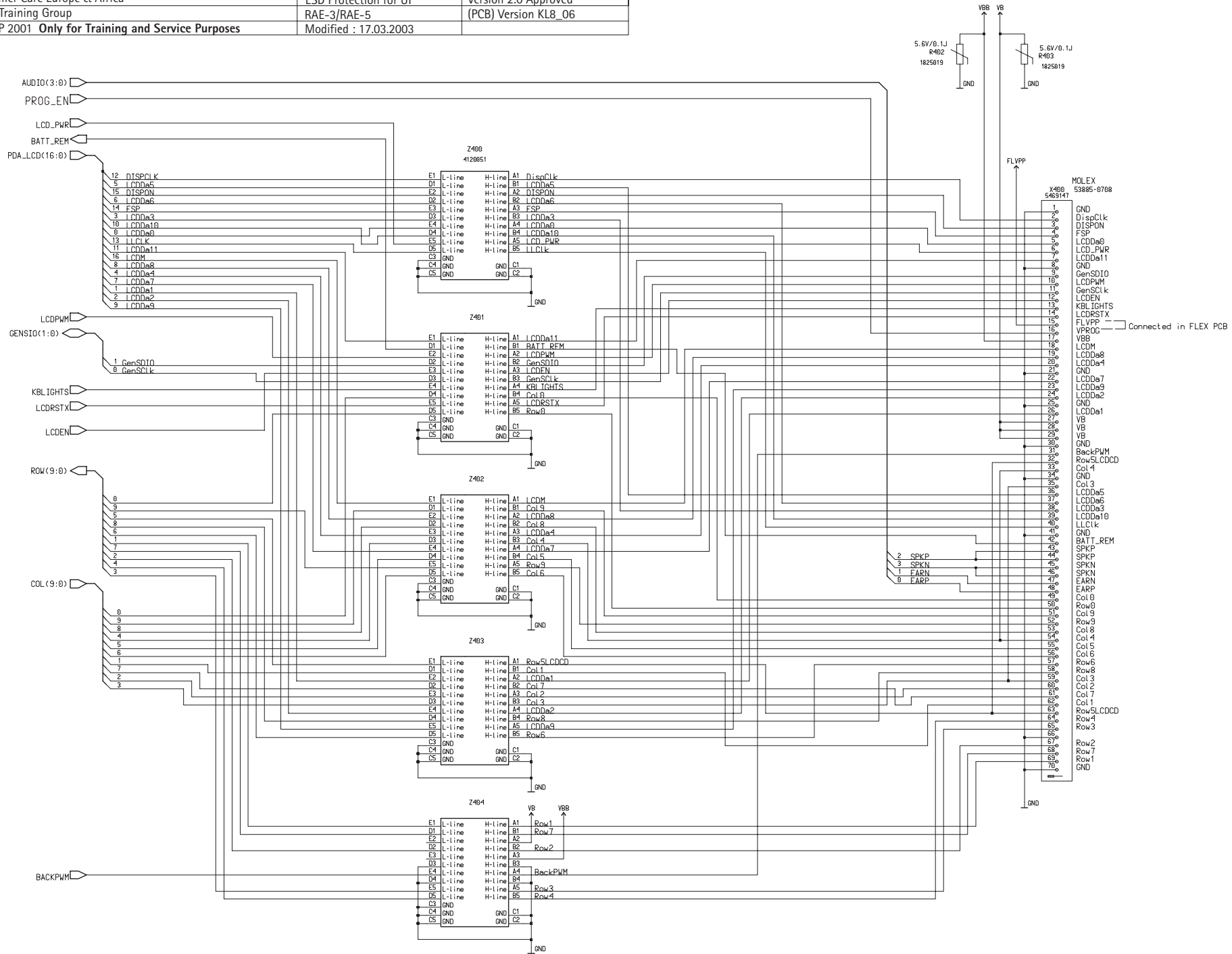

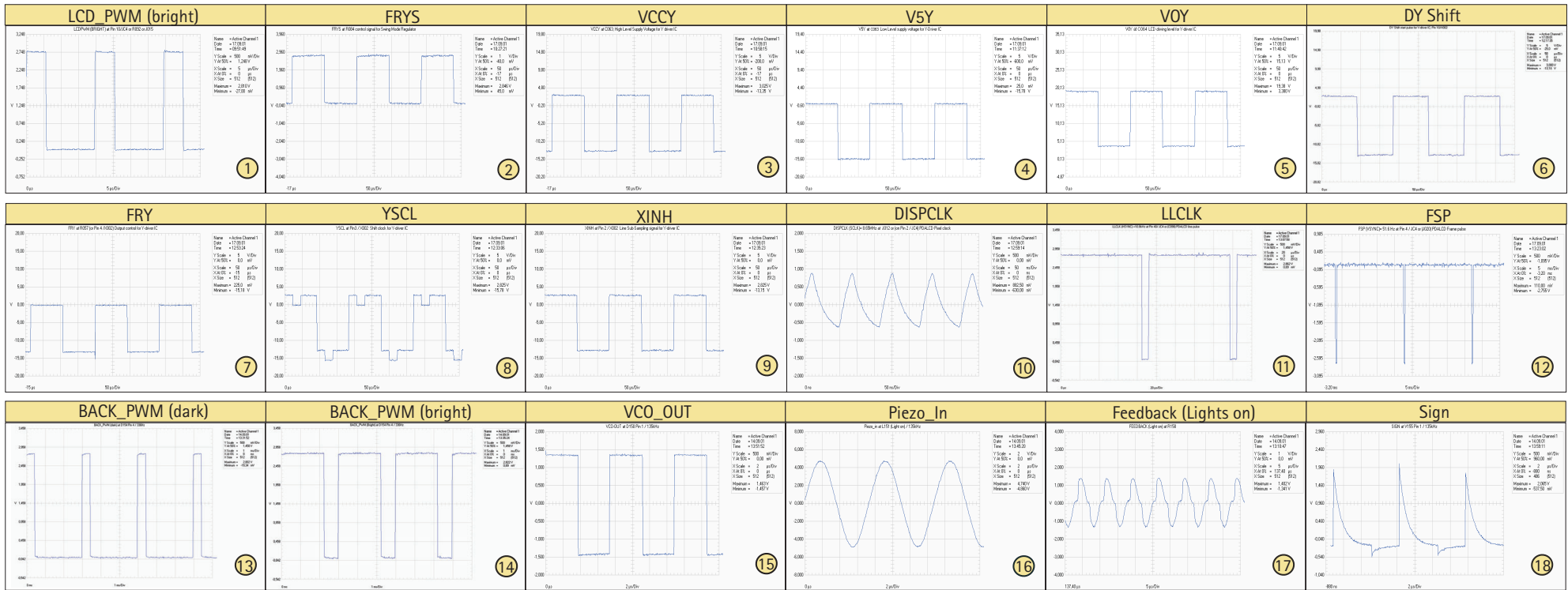
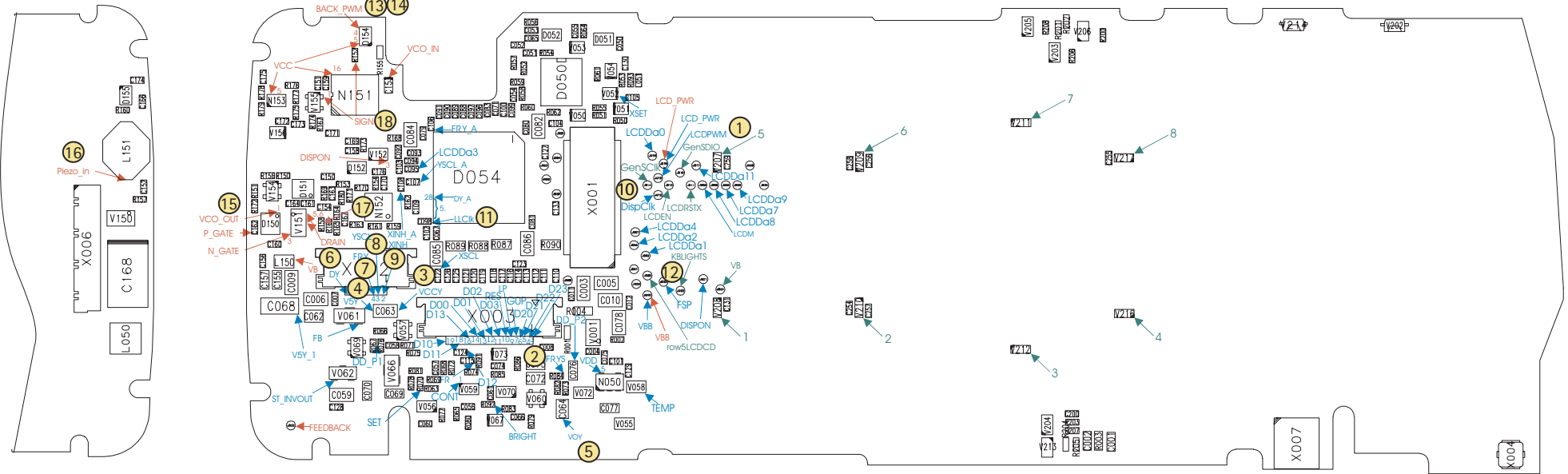

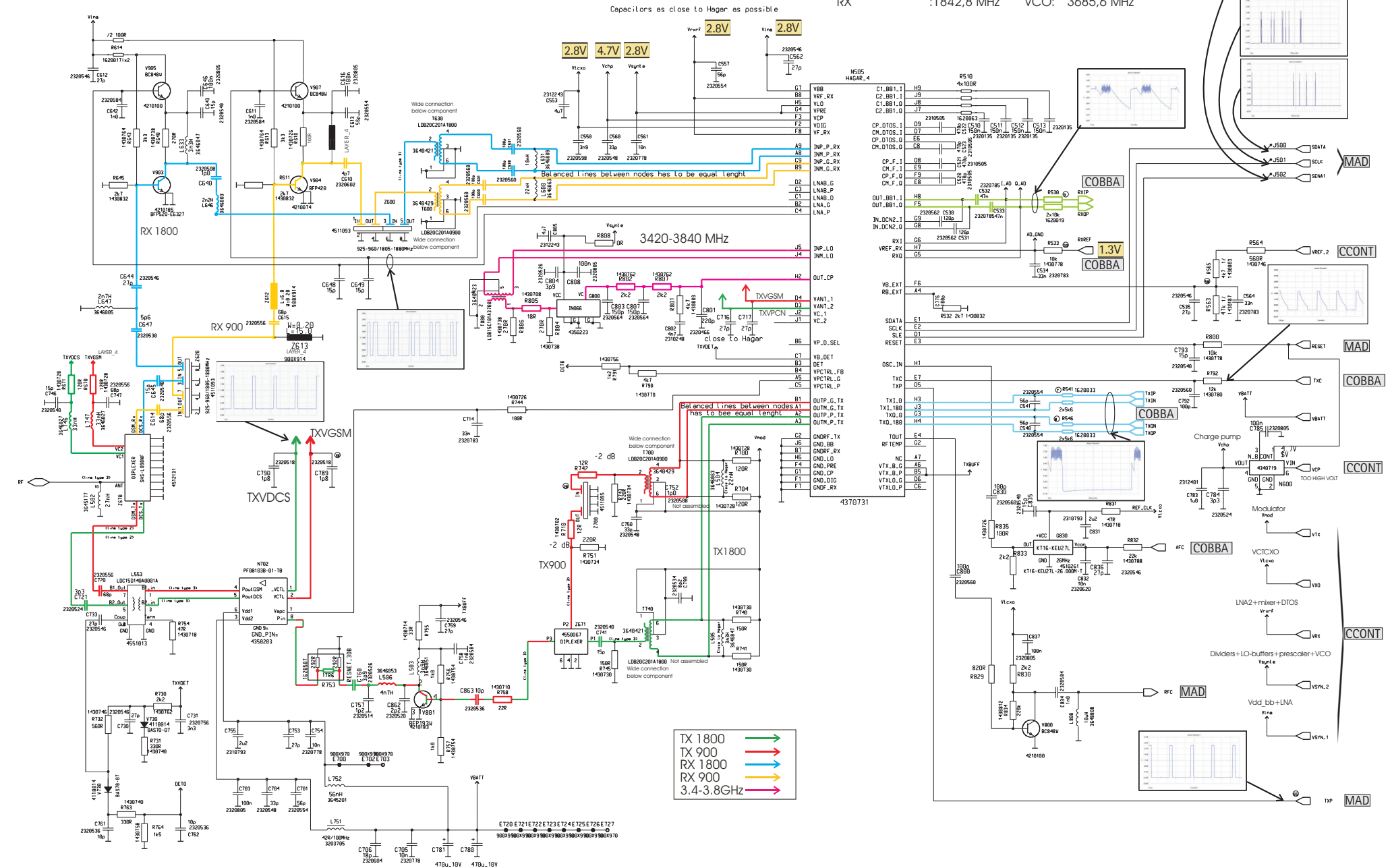

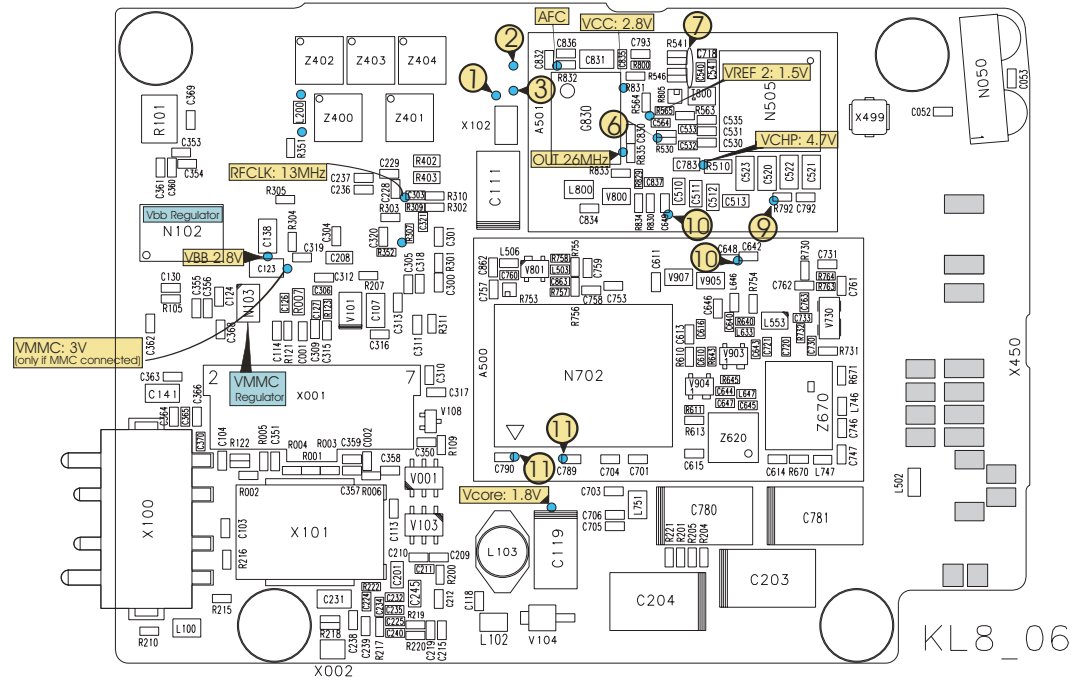
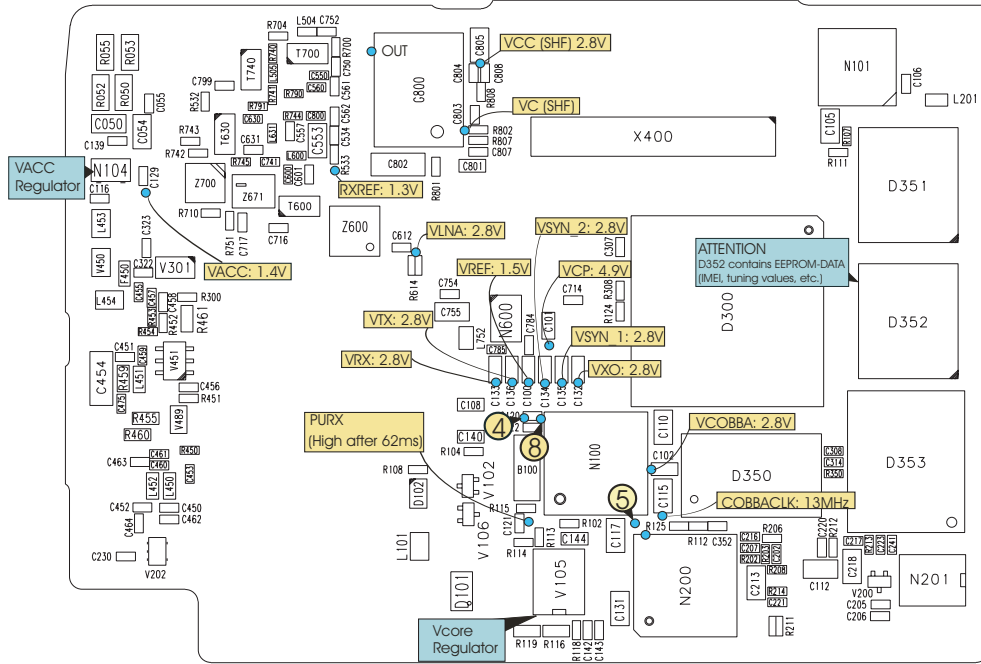

KL8\_06

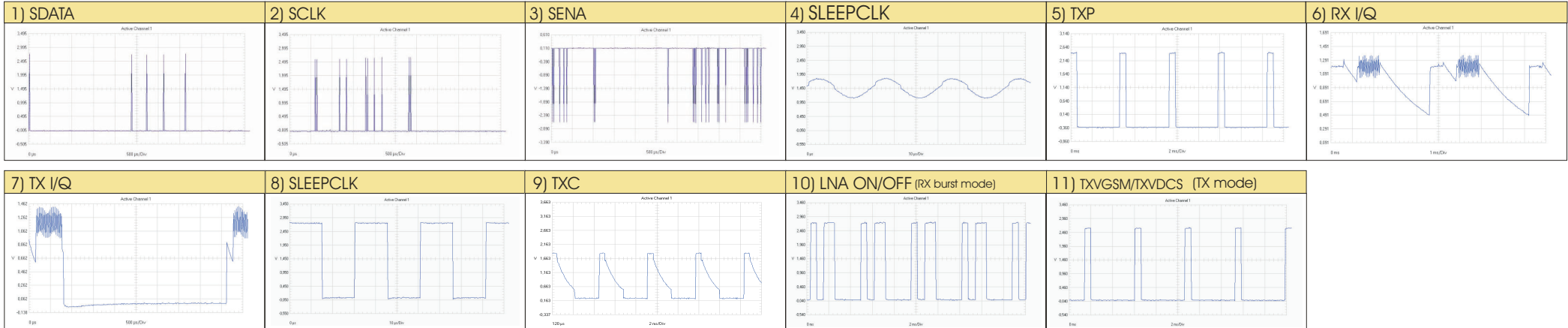



<b>A</b>	C205 - F9	C352 - E8	C610 - E3	C802 - C6	L101 - C9	R113 - D9	R510 - E2	T740 - B6
A500 - C3	C206 - F9	C353 - A2	C611 - D3	C803 - D6	L102 - C5	R114 - D9	R530 - E2	T800 - E1
A501 - D2	C207 - E9	C354 - A2	C612 - C7	C804 - D6	L103 - C4	R115 - D8	R532 - B6	<b>V</b>
<b>B</b>	C208 - B2	C355 - A3	C613 - E3	C805 - D5	L200 - B1	R116 - D9	R533 - C6	V001 - C4
B100 - D8	C209 - C4	C356 - B3	C614 - E4	C807 - D6	L201 - G6	R118 - D9	R541 - E1	V101 - B3
<b>C</b>	C210 - C4	C357 - C4	C615 - E4	C808 - D6	L450 - B8	R119 - D9	R546 - E1	V102 - D8
C001 - B3	C211 - C4	C358 - C4	C616 - E3	C830 - D2	L451 - A8	R121 - B3	R563 - E1	V103 - C4
C002 - C4	C212 - C5	C359 - C4	C630 - B6	C831 - D1	L452 - B8	R122 - B4	R610 - E3	V104 - D5
C050 - A6	C213 - E9	C360 - A2	C631 - B6	C832 - D1	L453 - A7	R123 - B3	R611 - E3	V105 - D9
C052 - F1	C215 - C5	C361 - A2	C640 - E3	C834 - D2	L454 - A7	R124 - E7	R613 - E3	V106 - D8
C053 - G1	C216 - E9	C362 - A3	C642 - E2	C835 - D1	L502 - F4	R125 - E8	R614 - C7	V108 - C3
C054 - A6	C217 - F9	C362 - A3	C643 - E3	C836 - D1	L503 - D2	R200 - C4	R640 - E3	V200 - F9
C055 - B6	C218 - F9	C364 - A3	C644 - E3	C837 - D2	L504 - C5	R201 - E9	R643 - E3	V202 - B9
C100 - D8	C219 - C5	C365 - A3	C645 - E3	C862 - C2	L505 - B6	R202 - E9	R645 - E3	V301 - B7
C101 - D7	C220 - F9	C366 - B3	C646 - E3	C863 - D2	L506 - D2	R203 - E9	R670 - E4	V450 - A7
C102 - E8	C221 - F9	C369 - A1	C647 - E3	<b>D</b>	L553 - E3	R204 - E4	R671 - F3	V451 - B7
C103 - B4	C223 - F9	C370 - B4	C648 - E2	D101 - D9	L600 - B6	R205 - E4	R700 - C5	V489 - B8
C104 - B4	C224 - C5	C450 - B8	C649 - E2	D102 - C8	L631 - B6	R206 - E9	R704 - B5	V730 - F3
C105 - F6	C225 - C5	C451 - A7	C701 - D4	D300 - E7	L633 - E3	R207 - C3	R710 - B6	V800 - D2
C106 - F6	C228 - C2	C452 - A8	C703 - D4	D350 - E8	L646 - E3	R208 - F9	R730 - E2	V801 - D2
C107 - C3	C229 - C2	C453 - B8	C704 - D4	D351 - F6	L647 - F4	R210 - A5	R731 - F3	V903 - E3
C108 - D8	C230 - A9	C454 - A8	C705 - D4	D352 - F7	L747 - F4	R211 - F9	R732 - E3	V904 - E3
C110 - E8	C231 - B5	C455 - A7	C706 - D4	D353 - F8	L751 - D4	R212 - F9	R740 - B5	V905 - E3
C111 - C2	C232 - C5	C456 - B8	C714 - D7	<b>F</b>	L752 - D7	R213 - F9	R741 - B6	V907 - E3
C112 - F9	C234 - C5	C457 - B7	C716 - B7	F450 - A7	L800 - D2	R214 - F9	R742 - B6	<b>X</b>
C113 - C4	C235 - B5	C458 - B7	C717 - B7	<b>G</b>	<b>N</b>	R215 - B4	R743 - B6	X001 - B3
C114 - B3	C236 - C2	C459 - A7	C718 - E1	G800 - C6	N050 - G1	R216 - E9	R744 - B6	X002 - B5
C115 - E8	C237 - C2	C460 - B8	C720 - E3	G830 - D1	N100 - D8	R217 - B5	R745 - B6	X100 - A4
C116 - A6	C238 - C5	C461 - B8	C721 - E3	<b>J</b>	N101 - F6	R218 - B5	R751 - B7	X101 - B4
C117 - D9	C239 - C5	C462 - B8	C730 - E3	J301 - F6	N102 - A2	R219 - B5	R753 - D3	X102 - C2
C118 - C5	C240 - C5	C463 - A8	C731 - F2	J310 - F8	N103 - B3	R220 - B5	R754 - E3	X400 - E6
C119 - D4	C241 - F9	C464 - A8	C733 - E3	J316 - F8	N104 - A6	R221 - E4	R755 - D3	X499 - F1
C120 - D8	C245 - C5	C475 - A8	C741 - B6	J318 - E7	N200 - E9	R222 - C5	R756 - D2	<b>Z</b>
C121 - D8	C300 - C3	C510 - E2	C746 - F3	J319 - D8	N201 - F9	R300 - B7	R757 - D3	Z400 - B1
C122 - D8	C301 - C2	C511 - E2	C747 - F4	J320 - E8	N505 - E1	R301 - C2	R758 - D2	Z401 - C1
C123 - B2	C303 - C2	C512 - E2	C750 - C6	J321 - E8	N600 - D7	R302 - C2	R763 - F3	Z402 - B1
C124 - B3	C304 - B2	C513 - E2	C752 - C5	J323 - D9	N702 - D3	R303 - C2	R764 - F3	Z403 - C1
C126 - B3	C305 - C3	C520 - E2	C753 - D3	J324 - E9	<b>R</b>	R304 - B2	R790 - B6	Z404 - C1
C127 - B3	C306 - B3	C521 - E2	C754 - C7	J327 - F6	R001 - B4	R305 - B2	R791 - B6	Z600 - C7
C129 - A6	C307 - E7	C522 - E2	C755 - C7	J328 - C2	R002 - B4	R307 - C2	R792 - E2	Z620 - E4
C130 - A3	C308 - F8	C523 - E2	C757 - C3	J329 - F6	R003 - B4	R308 - E7	R800 - D1	Z670 - E3
C131 - E9	C309 - B3	C530 - E2	C758 - D3	J338 - F7	R004 - B4	R309 - C2	R801 - C6	Z671 - B6
C132 - D7	C310 - C3	C531 - E2	C759 - D2	J339 - F7	R005 - B4	R310 - C2	R802 - D6	Z700 - B6
C133 - D7	C311 - C3	C532 - E2	C760 - C2	J340 - F8	R006 - C4	R311 - C3	R804 - D1	
C134 - D7	C312 - B3	C533 - E2	C761 - F3	J341 - F6	R007 - B3	R350 - F8	R805 - E1	
C135 - D7	C313 - C3	C534 - C6	C762 - E3	J342 - F7	R050 - A6	R351 - B2	R807 - D6	
C136 - D7	C314 - F8	C535 - E2	C780 - E4	J343 - F7	R052 - A6	R352 - C2	R808 - D6	
C138 - B2	C315 - B3	C540 - E1	C781 - E4	J346 - B2	R053 - A5	R402 - C2	R829 - D2	
C139 - A6	C316 - C3	C541 - E1	C783 - E2	J347 - F7	R055 - A5	R403 - C2	R830 - D2	
C140 - D8	C317 - C3	C550 - C6	C784 - D7	J348 - F8	R101 - A1	R450 - B8	R831 - D1	
C141 - A3	C318 - C3	C553 - C6	C785 - D7	J349 - E8	R102 - D8	R451 - B8	R832 - D1	
C142 - D9	C319 - B2	C557 - B6	C789 - D4	J350 - F8	R104 - D8	R452 - B7	R833 - D2	
C143 - D9	C320 - C2	C560 - C6	C790 - C4	J351 - F6	R105 - A3	R453 - B7	R834 - D2	
C144 - D9	C321 - C2	C561 - C6	C792 - E2	J500 - C1	R107 - F6	R454 - B7	R835 - D2	
C201 - C4	C322 - A7	C562 - C6	C793 - D1	J501 - D1	R108 - C8	R455 - B8	<b>T</b>	
C202 - F9	C323 - A7	C564 - E2	C799 - B6	J502 - D1	R109 - C4	R459 - A8	T600 - B6	
C203 - E4	C350 - C4	C600 - B6	C800 - C6	<b>L</b>	R111 - F6	R460 - B8	T630 - B6	
C204 - D5	C351 - B4	C601 - C6	C801 - D6	L100 - A5	R112 - E8	R461 - B7	T700 - C5	

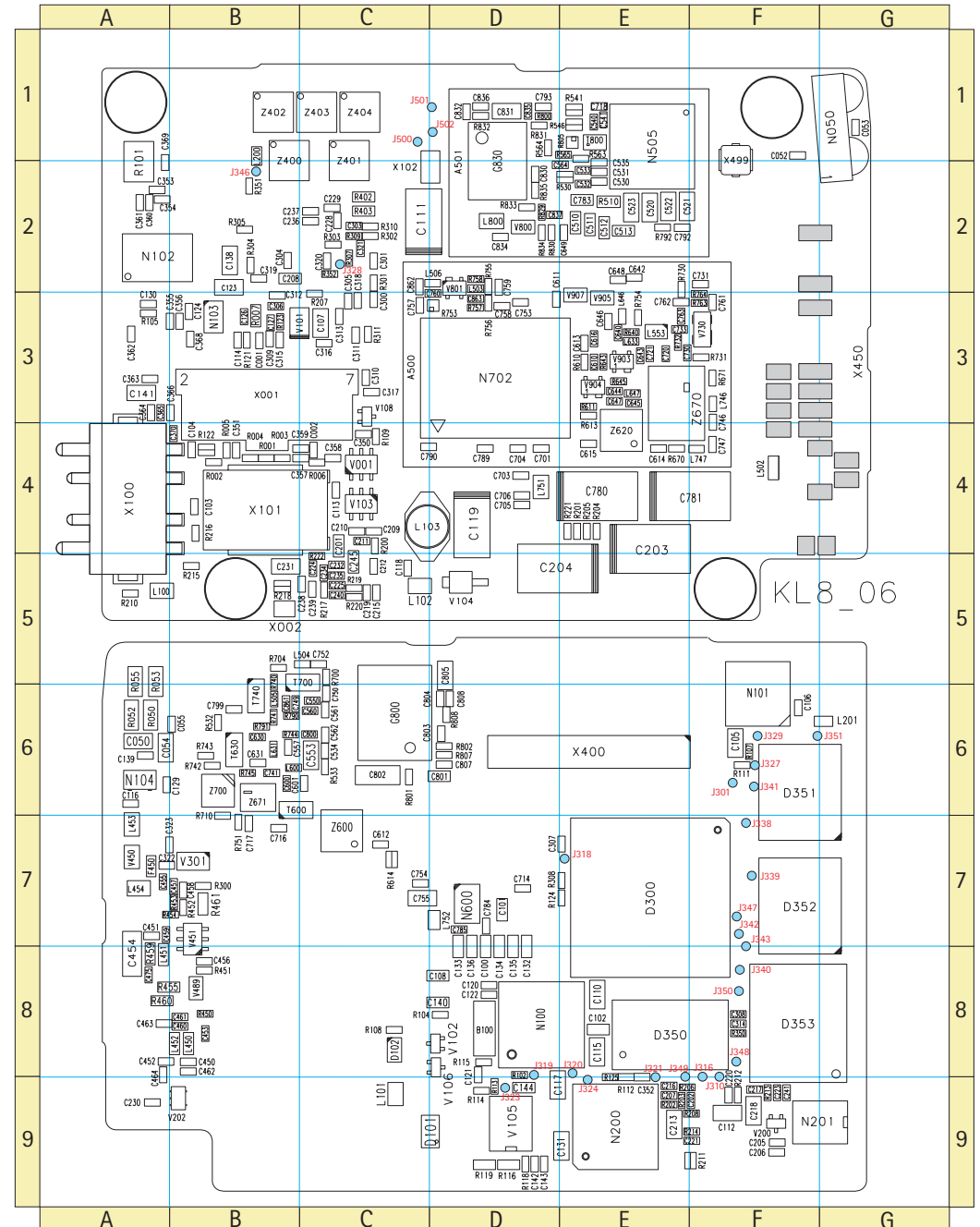

<b>B</b>	C204 - D4	C316 - C3	C535 - E1	C764 - F3	J324 - E8	<b>R</b>	R305 - B2	R805 - E1
B100 - D8	C205 - F9	C317 - C3	C540 - E1	C776 - B6	J327 - F6	R001 - B4	R308 - E7	R806 - D1
<b>C</b>	C206 - F9	C318 - C2	C541 - E1	C780 - E4	J328 - C2	R003 - B4	R309 - C2	R807 - D6
C001 - B3	C207 - E9	C319 - B2	C550 - C6	C781 - E4	J329 - F6	R004 - B4	R310 - C2	R808 - D6
C002 - C4	C208 - B2	C320 - C2	C553 - C6	C783 - E2	J338 - F7	R005 - B4	R311 - C3	R829 - D2
C050 - A6	C209 - C4	C321 - C2	C556 - C7	C784 - D7	J339 - F7	R006 - C4	R402 - C2	R830 - D2
C052 - F1	C210 - C4	C322 - A7	C557 - B6	C785 - D7	J340 - F8	R007 - B3	R403 - C2	R831 - D1
C053 - G1	C211 - C4	C323 - B7	C560 - C6	C789 - D4	J341 - F6	R050 - A6	R450 - B8	R832 - D1
C054 - A6	C212 - C4	C350 - C3	C561 - C6	C790 - C4	J342 - F8	R052 - A6	R451 - B8	R834 - D2
C055 - B6	C213 - E9	C351 - B4	C562 - C6	C792 - E2	J343 - G6	R053 - A5	R455 - B8	R835 - D2
C100 - D8	C214 - E9	C352 - E8	C600 - B6	C793 - D1	J346 - B2	R055 - A5	R460 - B8	<b>T</b>
C101 - D7	C215 - B5	C354 - A2	C601 - C6	C799 - B6	J347 - F7	R101 - A1	R461 - B7	T600 - B6
C102 - E8	C216 - E9	C354 - A2	C610 - E3	C800 - C6	J348 - F8	R102 - D8	R461 - B7	T630 - B6
C103 - B4	C217 - F9	C355 - A3	C611 - D2	C801 - D6	J349 - E8	R104 - D8	R510 - E2	T700 - B5
C104 - B4	C218 - F9	C356 - B3	C612 - C7	C802 - C6	J350 - F8	R105 - A3	R532 - B6	T740 - B6
C105 - F6	C219 - B5	C357 - B4	C613 - E3	C803 - D6	J351 - F6	R107 - F6	R533 - C6	T800 - E1
C106 - F6	C220 - F9	C358 - C4	C614 - E4	C804 - D6	J501 - C1	R108 - C8	R541 - E1	<b>V</b>
C107 - C3	C221 - F9	C359 - B4	C615 - E4	C805 - D5	J502 - C1	R109 - C3	R546 - E1	V001 - C4
C108 - D8	C223 - F9	C360 - A2	C616 - E3	C807 - D6	<b>L</b>	R111 - F6	R563 - E1	V101 - B3
C109 - E7	C224 - B4	C361 - A2	C630 - B6	C808 - D6	L100 - A5	R112 - E8	R564 - D1	V102 - D8
C110 - E8	C225 - B5	C362 - A1	C631 - B6	C830 - D2	L101 - C9	R113 - D9	R565 - D1	V103 - C4
C111 - C2	C228 - C2	C362 - A3	C640 - E3	C831 - D1	L102 - B5	R114 - D9	R564 - D1	V104 - D5
C112 - F9	C229 - C2	C364 - A3	C642 - E2	C832 - D1	L103 - C4	R115 - D8	R565 - D1	V105 - D9
C113 - C4	C230 - A9	C365 - A3	C643 - E3	C834 - D2	L200 - B1	R116 - D9	R610 - E3	V106 - D8
C114 - B3	C231 - B4	C366 - G8	C644 - E3	C835 - D1	L201 - G6	R118 - D9	R611 - E3	V108 - C3
C115 - E8	C232 - C4	C369 - A1	C645 - E3	C836 - D1	L450 - B8	R119 - D9	R614 - C7	V200 - F9
C116 - B6	C234 - B5	C370 - G8	C646 - E3	C837 - D2	L452 - B8	R121 - B3	R640 - E3	V202 - B9
C117 - B7	C235 - B5	C371 - B4	C647 - E3	C860 - B6	L453 - A7	R122 - B4	R643 - E3	V301 - B7
C118 - C4	C236 - C2	C450 - B8	C648 - E2	C861 - B6	L454 - A7	R123 - B3	R645 - E3	V450 - A7
C119 - D4	C237 - B2	C451 - A7	C649 - D2	C862 - C2	L502 - F4	R125 - E8	R670 - F4	V451 - B7
C120 - D8	C238 - B5	C452 - B8	C704 - D4	C863 - D2	L503 - D2	R200 - C9	R671 - F3	V489 - B8
C121 - D8	C239 - C5	C453 - B8	C705 - D4	<b>D</b>	L504 - B5	R202 - E4	R700 - B5	V730 - D2
C122 - B8	C240 - B5	C454 - A8	C706 - D4	D101 - D9	L505 - B6	R203 - E9	R710 - B6	V800 - D3
C123 - B2	C241 - F9	C455 - A7	C714 - D7	D102 - C8	L506 - C2	R204 - E4	R730 - E3	V903 - E3
C124 - B2	C243 - B4	C456 - B8	C715 - B6	D254 - B1	L553 - E3	R205 - E4	R731 - F3	V904 - E3
C126 - B3	C244 - B4	C457 - B7	C716 - B7	D300 - E7	L600 - B6	R207 - C2	R741 - B6	V905 - E2
C127 - B3	C245 - C4	C461 - B7	C717 - B7	D350 - E8	L631 - B6	R208 - F9	R742 - B6	V907 - E2
C129 - A6	C300 - C2	C462 - B8	C720 - E3	D351 - F6	L646 - E3	R209 - F9	R743 - B6	<b>X</b>
C130 - A2	C301 - C2	C470 - B8	C721 - E3	D352 - F7	L746 - F3	R210 - A5	R744 - B6	X001 - B3
C131 - E9	C302 - C2	C475 - A8	C731 - F2	D353 - F8	L751 - D4	R211 - F9	R745 - B6	X100 - A4
C132 - D7	C303 - C2	C510 - E2	C741 - B6	F450 - A7	L752 - D7	R212 - F9	R751 - B7	X101 - B4
C133 - D7	C304 - B2	C511 - E2	C746 - E3	<b>G</b>	L800 - D2	R213 - F9	R753 - C3	X102 - C1
C134 - D7	C305 - C2	C512 - E2	C749 - B6	G800 - C6	N050 - G1	R214 - F9	R754 - E3	X400 - E6
C135 - D7	C306 - B3	C513 - E2	C750 - C6	G830 - D1	N100 - D8	R215 - B4	R755 - D2	X450 - F3
C136 - B7	C307 - E7	C520 - E2	C752 - B5	<b>J</b>	N101 - F6	R216 - E9	R756 - D2	X499 - F1
C138 - D2	C308 - F8	C521 - E2	C753 - D2	J301 - F6	N102 - A2	R217 - B5	R757 - D2	<b>Z</b>
C140 - D8	C309 - B3	C522 - E2	C754 - C7	J310 - F8	N103 - B3	R218 - B5	R758 - D2	Z400 - B1
C142 - D9	C310 - C3	C523 - E2	C755 - C7	J316 - F8	N104 - A6	R219 - B5	R763 - E2	Z402 - B1
C143 - D9	C311 - C3	C530 - E2	C757 - C3	J318 - E7	N200 - E9	R220 - B5	R764 - E2	Z403 - C1
C144 - D9	C312 - B2	C531 - E2	C758 - D2	J319 - D8	N201 - F9	R300 - B7	R791 - B6	Z404 - C1
C201 - C4	C313 - C3	C532 - E2	C759 - D2	J320 - E8	N505 - E1	R301 - C2	R792 - E2	Z600 - C7
C202 - F9	C314 - F8	C533 - E1	C760 - C2	J321 - E8	N600 - D7	R302 - C2	R800 - D1	Z620 - E3
C203 - E4	C315 - B3	C534 - C6	C761 - F2	J323 - D9	N702 - D3	R303 - C2	R801 - C6	Z670 - E3
						R304 - B2	R804 - D1	Z671 - B6
								Z700 - B6

