

Engineer		COMPANY NAME	
Drawn by		Address	
EST CODE		City	
PROJECT CODE			
WFO BOARD CODE			
SGH-U600			

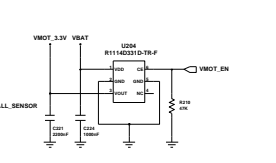

Engineer		COMPANY NAME	
Drawn by	DATE	Address	REV
Checked by	DATE	City	DATE
Approved by	DATE	SGH-U600	
Project Manager	DATE		
Part No.	Rev. No.	Sheet No.	Total No.

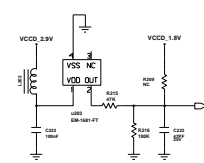
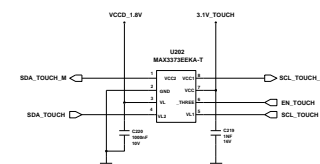
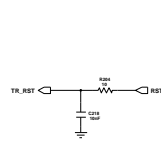
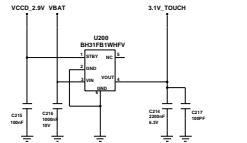
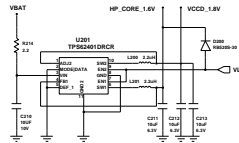
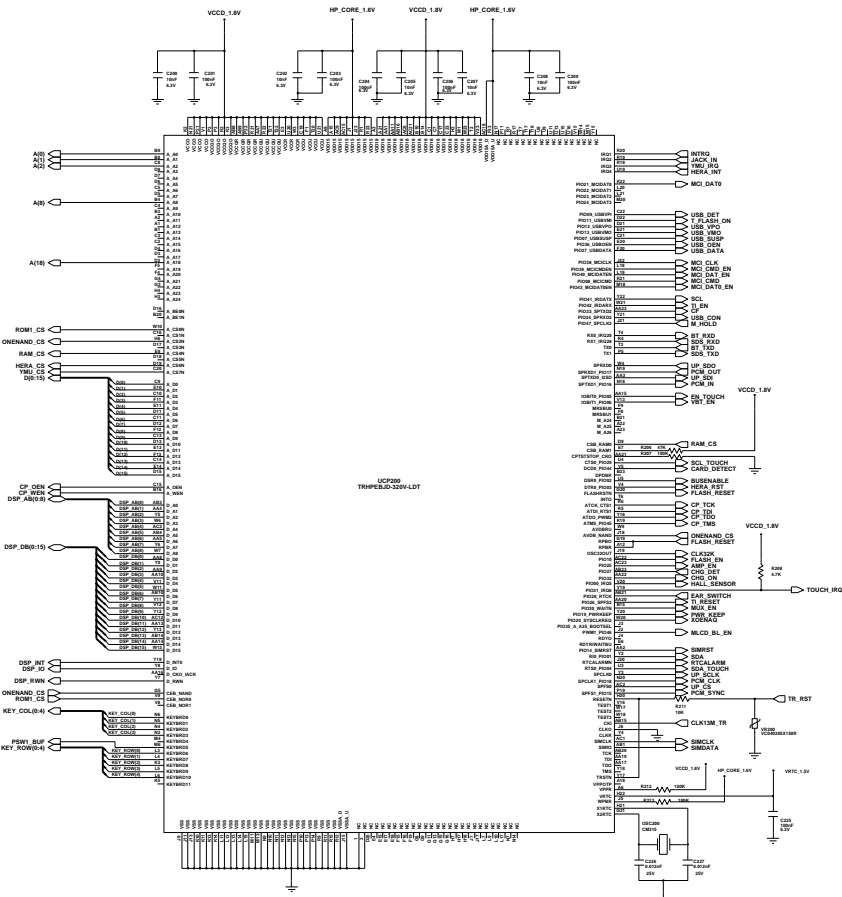
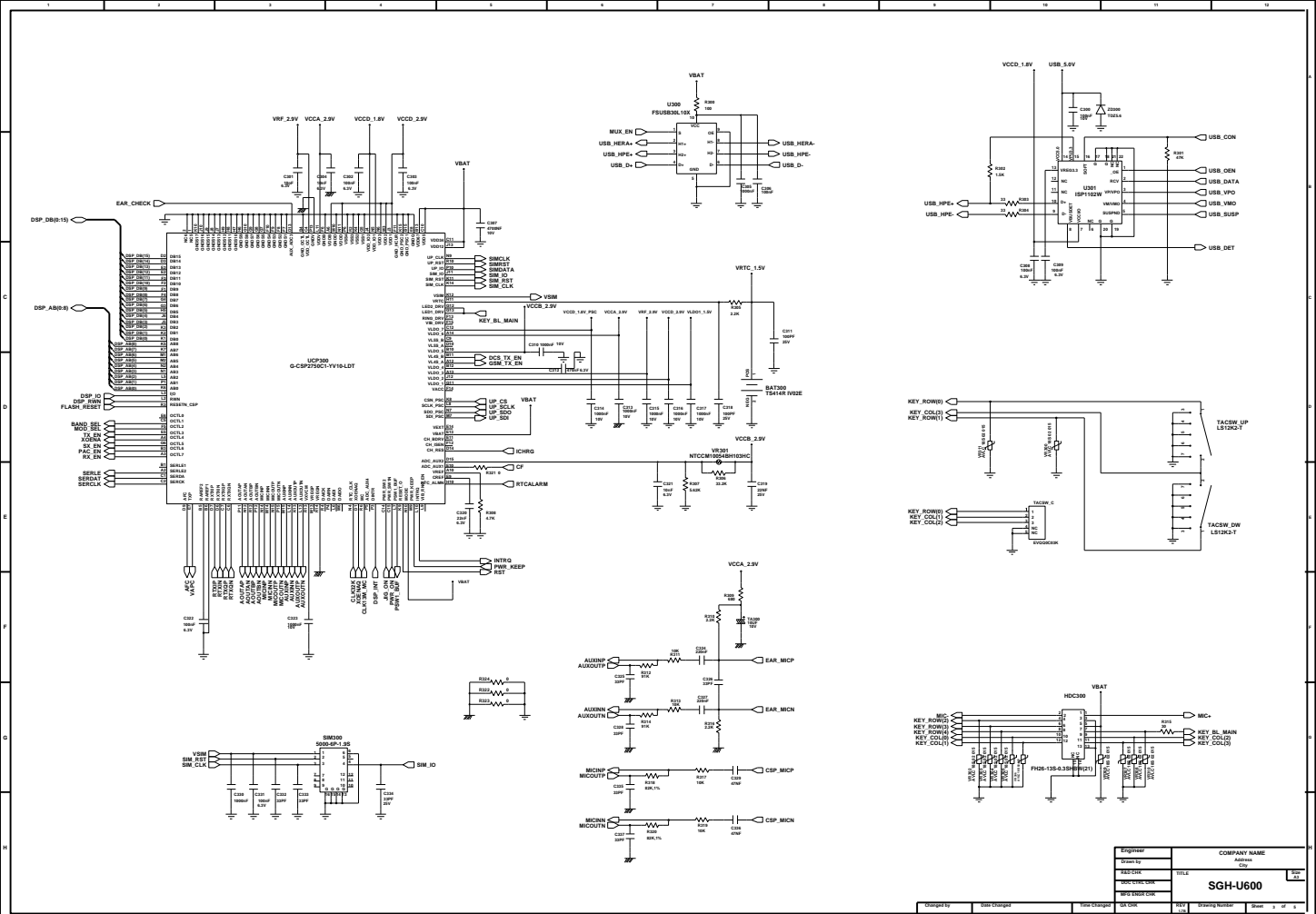

Engineer	COMPANY NAME
Drawn by	Address
REV. 002	TEL
REV. 003	TEL
REV. 004	TEL
REV. 005	TEL
REV. 006	TEL
REV. 007	TEL
REV. 008	TEL
REV. 009	TEL
REV. 010	TEL
REV. 011	TEL
REV. 012	TEL
REV. 013	TEL
REV. 014	TEL
REV. 015	TEL
REV. 016	TEL
REV. 017	TEL
REV. 018	TEL
REV. 019	TEL
REV. 020	TEL
REV. 021	TEL
REV. 022	TEL
REV. 023	TEL
REV. 024	TEL
REV. 025	TEL
REV. 026	TEL
REV. 027	TEL
REV. 028	TEL
REV. 029	TEL
REV. 030	TEL
REV. 031	TEL
REV. 032	TEL
REV. 033	TEL
REV. 034	TEL
REV. 035	TEL
REV. 036	TEL
REV. 037	TEL
REV. 038	TEL
REV. 039	TEL
REV. 040	TEL
REV. 041	TEL
REV. 042	TEL
REV. 043	TEL
REV. 044	TEL
REV. 045	TEL
REV. 046	TEL
REV. 047	TEL
REV. 048	TEL
REV. 049	TEL
REV. 050	TEL
REV. 051	TEL
REV. 052	TEL
REV. 053	TEL
REV. 054	TEL
REV. 055	TEL
REV. 056	TEL
REV. 057	TEL
REV. 058	TEL
REV. 059	TEL
REV. 060	TEL
REV. 061	TEL
REV. 062	TEL
REV. 063	TEL
REV. 064	TEL
REV. 065	TEL
REV. 066	TEL
REV. 067	TEL
REV. 068	TEL
REV. 069	TEL
REV. 070	TEL
REV. 071	TEL
REV. 072	TEL
REV. 073	TEL
REV. 074	TEL
REV. 075	TEL
REV. 076	TEL
REV. 077	TEL
REV. 078	TEL
REV. 079	TEL
REV. 080	TEL
REV. 081	TEL
REV. 082	TEL
REV. 083	TEL
REV. 084	TEL
REV. 085	TEL
REV. 086	TEL
REV. 087	TEL
REV. 088	TEL
REV. 089	TEL
REV. 090	TEL
REV. 091	TEL
REV. 092	TEL
REV. 093	TEL
REV. 094	TEL
REV. 095	TEL
REV. 096	TEL
REV. 097	TEL
REV. 098	TEL
REV. 099	TEL
REV. 100	TEL
REV. 101	TEL
REV. 102	TEL
REV. 103	TEL
REV. 104	TEL
REV. 105	TEL
REV. 106	TEL
REV. 107	TEL
REV. 108	TEL
REV. 109	TEL
REV. 110	TEL
REV. 111	TEL
REV. 112	TEL
REV. 113	TEL
REV. 114	TEL
REV. 115	TEL
REV. 116	TEL
REV. 117	TEL
REV. 118	TEL
REV. 119	TEL
REV. 120	TEL
REV. 121	TEL
REV. 122	TEL
REV. 123	TEL
REV. 124	TEL
REV. 125	TEL
REV. 126	TEL
REV. 127	TEL
REV. 128	TEL
REV. 129	TEL
REV. 130	TEL
REV. 131	TEL
REV. 132	TEL
REV. 133	TEL
REV. 134	TEL
REV. 135	TEL
REV. 136	TEL
REV. 137	TEL
REV. 138	TEL
REV. 139	TEL
REV. 140	TEL
REV. 141	TEL
REV. 142	TEL
REV. 143	TEL
REV. 144	TEL
REV. 145	TEL
REV. 146	TEL
REV. 147	TEL
REV. 148	TEL
REV. 149	TEL
REV. 150	TEL
REV. 151	TEL
REV. 152	TEL
REV. 153	TEL
REV. 154	TEL
REV. 155	TEL
REV. 156	TEL
REV. 157	TEL
REV. 158	TEL
REV. 159	TEL
REV. 160	TEL
REV. 161	TEL
REV. 162	TEL
REV. 163	TEL
REV. 164	TEL
REV. 165	TEL
REV. 166	TEL
REV. 167	TEL
REV. 168	TEL
REV. 169	TEL
REV. 170	TEL
REV. 171	TEL
REV. 172	TEL
REV. 173	TEL
REV. 174	TEL
REV. 175	TEL
REV. 176	TEL
REV. 177	TEL
REV. 178	TEL
REV. 179	TEL
REV. 180	TEL
REV. 181	TEL
REV. 182	TEL
REV. 183	TEL
REV. 184	TEL
REV. 185	TEL
REV. 186	TEL
REV. 187	TEL
REV. 188	TEL
REV. 189	TEL
REV. 190	TEL
REV. 191	TEL
REV. 192	TEL
REV. 193	TEL
REV. 194	TEL
REV. 195	TEL
REV. 196	TEL
REV. 197	TEL
REV. 198	TEL
REV. 199	TEL
REV. 200	TEL

SGH-U600

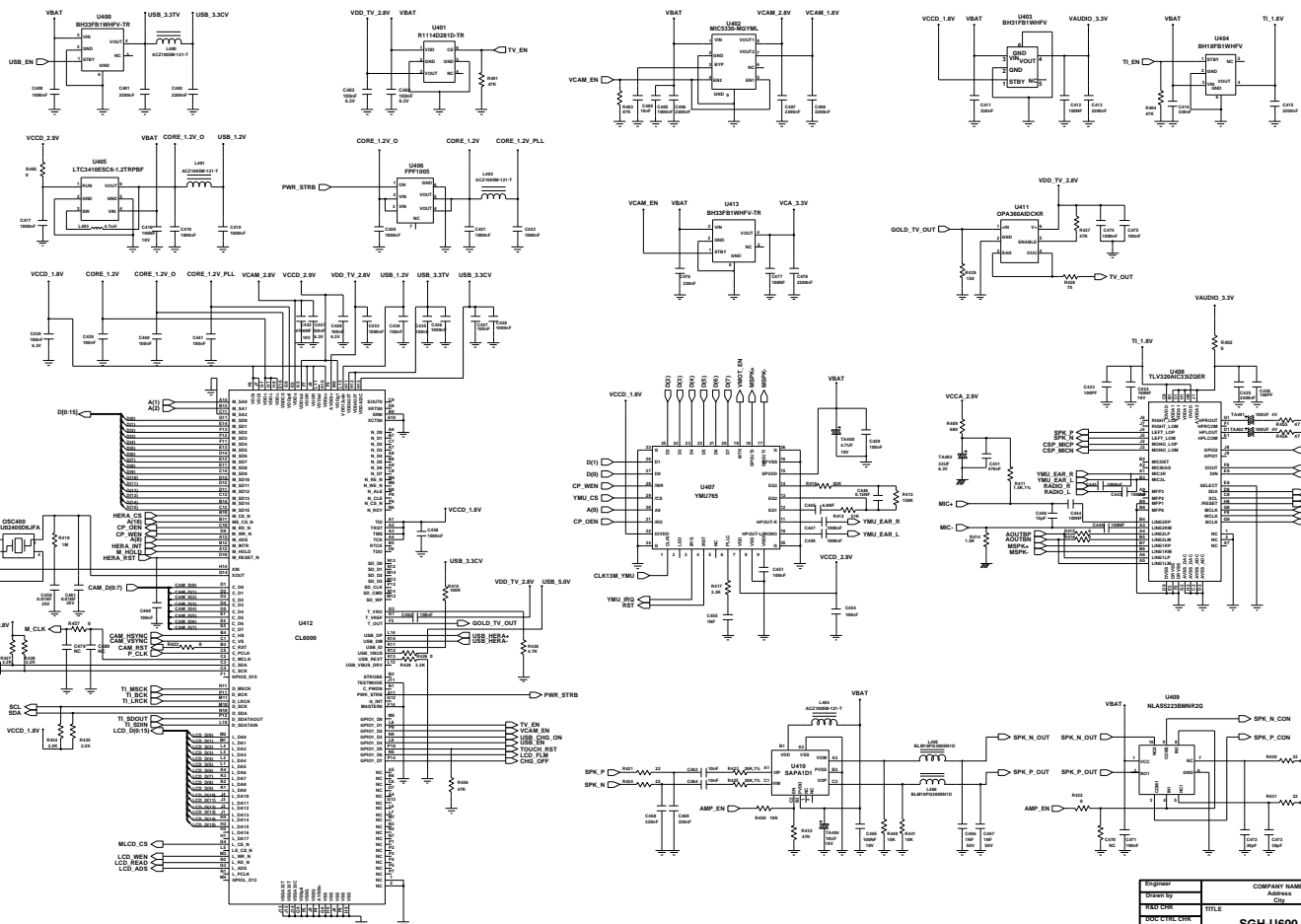

ENGINEER	COMPANY NAME
DESIGN BY	Address
REP. CHG.	City
DATE	
SGH-U600	
REV	REV. REVISION
DATE	DATE

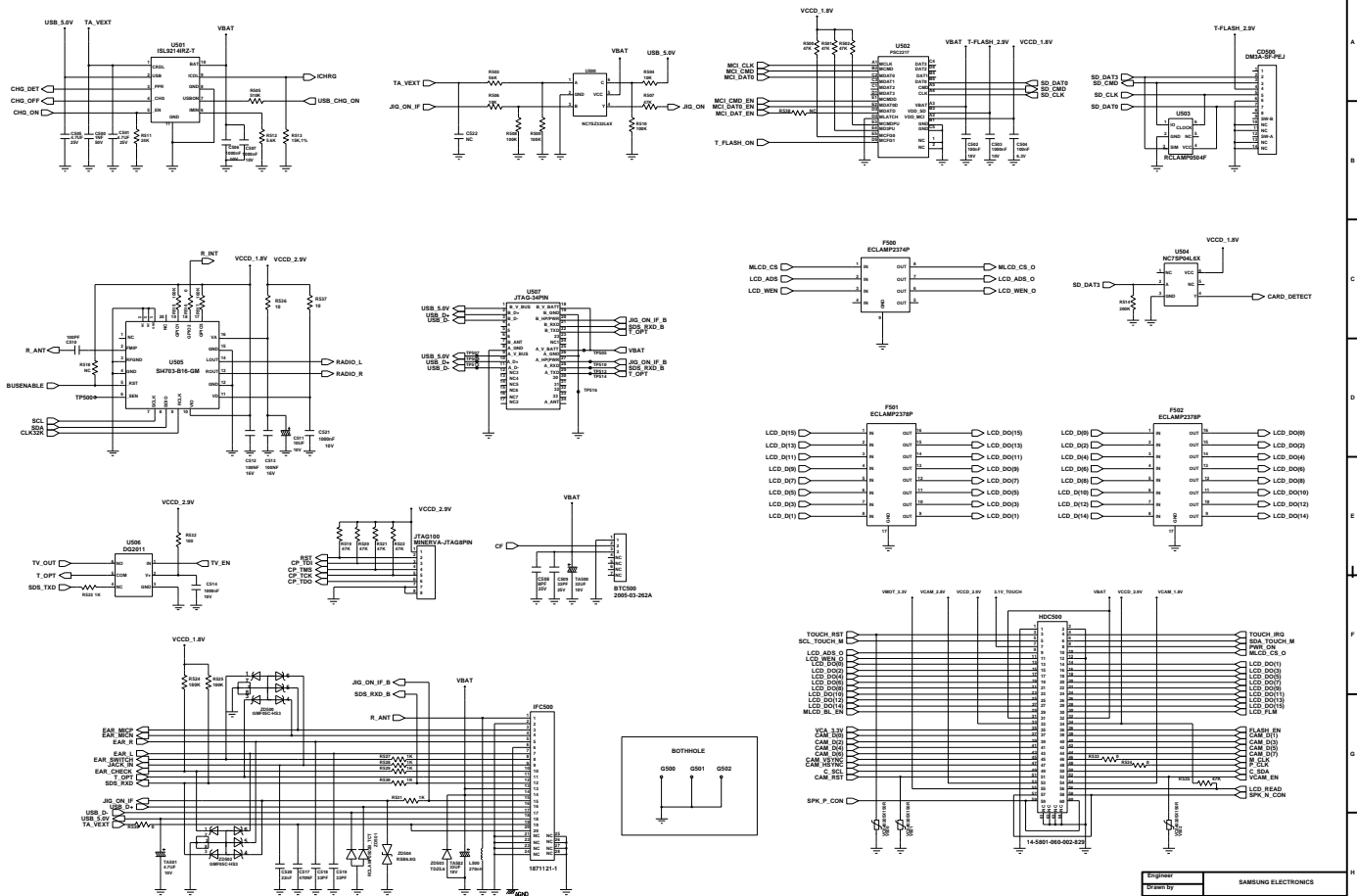

Engineer	SAMSUNG ELECTRONICS	
Drawn by	TITLE	REV
Check by	DATE	
Approved by	DATE	
Checked by	DATE	
SGH-U600		

