



Some of the contents in this manual may differ from your phone depending on the software of the phone or your service provider. This handset is not recommended for blind disability person due to touch screen keypad.



BL40 User Guide

Congratulations on your purchase of the advanced and compact BL40 phone by LG, designed to operate with the latest digital mobile communication technology.

Contents

Guidelines for safe and efficient use	8	Viewing the status bar	33
Getting to know your phone	19	Using the Multi-tasking function..	35
Open view	21	Calls	36
Installing the USIM and battery	22	Making a call or a video call.....	36
Charging your phone.....	24	Calling your contacts.....	36
Memory card.....	25	Answering and rejecting a call	36
Installing a memory card	25	In-call options	37
Formatting the memory card.....	26	Adjusting call volume	38
Transferring your contacts	26	Speed dialling	38
Menu map.....	27	Making a second call	38
Your home screen	28	Turning off DTMF.....	39
Touch screen tips.....	28	Viewing your call logs	39
Customising the home screen.....	29	Using call divert.....	40
Quick keys	31	Using call barring.....	40
Touch screen	32	Changing the common call setting.....	41
		Changing your video call settings.....	42
		Contacts.....	43
		Searching for a contact.....	43
		Adding a new contact.....	43
		Creating a group.....	44
		Changing your contact settings....	44
		Viewing information.....	45

Contents

Messaging 46

Messaging	46
Sending a message	46
Entering text.....	47
T9 predictive.....	47
Abc manual.....	47
Setting up your email.....	48
Retrieving your email	49
Sending an email using your new account.....	49
Changing your email settings.....	50
Message folders	51
Using templates	51
Using emoticons.....	52
Changing your text message settings.....	52
Changing your multimedia message settings.....	53
Changing your other settings.....	54

Camera 55

Taking a quick photo	55
Once you've taken the photo.....	56
Getting to know the viewfinder	57
Using the flash	58
Choosing a shot type	58
Taking a continuous shot	59

Using the advanced settings.....	59
Changing the image size	62
Choosing a colour effect.....	62
Using the secondary camera.....	63
Viewing your saved photos	63

Video camera 64

Shooting a quick video.....	64
After taking a video	65
Getting to know the viewfinder	66
Using the advanced settings.....	67
Changing the video image size	68
Choosing a colour tone	68
Using the secondary video camera	69
Watching your saved videos.....	69
Watching your videos on TV	70

Your photos and videos 71

Viewing your photos and videos ..	71
Using zoom when viewing a video or photo	71
Adjusting the volume when viewing a video	71
Setting a photo as wallpaper	72
Editing your photos	72
Adding text to a photo.....	74

Adding an effect to a photo	74	Creating a slide show	84
Cropping a photo	74	Geo-tagging	84
Adding a colour accent to a photo	75	Sounds.....	85
Swapping colours in a photo	75	Using a sound	85
Fog Drawing	76	Videos	85
Rain Drop.....	76	Sending a video clip	86
MotionBlur	77	Games and Applications	86
Artistic Effect	77	Playing a game	86
Editing your videos	77	Using the options menu	86
Trimming the length of the video	77	Installing a Java game and application	87
Merging two videos.....	78	Use the M-Toy menu.....	87
Merging a photo with a video	78	Flash contents.....	87
Adding text to a video	79	Viewing an SWF/ SVG file.....	87
Overlaying a photo	79	Documents	87
Adding a soundtrack to your video.....	80	Viewing a file	87
Adding live sound to your video... 80		Transferring a file to your phone... 88	
Adding a dimming effect.....	81	Others	88
Multimedia	82	Creating a movie.....	88
Pictures	82	Music	89
Images options menu	82	Transferring music onto your phone.....	90
Sending a photo	82	Playing a song.....	90
Using an image.....	83	Creating a playlist.....	91
Printing an image	83	Deleting a playlist.....	91
Moving or copying an image	84	Using the radio	91
		Searching for stations	92

Contents

Listening to the radio.....	93	Viewing phone files on your PC ..	100
Using the FM transmitter to play music.....	93	Synchronising your contacts.....	101
Organiser.....	94	Synchronising the messages.....	101
Adding an event to your calendar	94	Music Sync.....	101
Changing your default calendar view	94	Transferring music using Windows Media Player	102
Adding an item to your To Do list.	95	DivX Converter	103
Using the date finder.....	95	The web	104
Setting your alarm.....	96	Vodafone live!	104
Adding a memo	96	Accessing the web	104
Voice recorder.....	96	Adding and accessing bookmarks	104
Recording a sound or voice	97	Using the RSS reader	105
Sending the voice recording	97	Accessing a saved page.....	105
Using your calculator	97	Viewing your browser history	105
Converting a unit.....	98	Changing web browser settings.	106
Using the stopwatch	98	Using your phone as a modem ...	106
Adding a city to your world clock.	98	Settings	108
PC Suite	99	Changing your screen settings....	108
Installing the LG PC Suite on your computer	99	Personalising your profiles.....	108
Connecting your phone and PC....	99	Changing your phone settings....	109
Backing up and restoring your phone's information	100	Changing your touch settings	109
		Changing your connectivity settings.....	110
		Using memory manager	112

Using flight mode.....	112
Sending and receiving files using Bluetooth.....	112
Changing your Bluetooth settings.....	114
Pairing with another Bluetooth device.....	114
Using a Bluetooth headset.....	115
Wi-Fi.....	116
Phone Software update	118
Accessories	119
Network service	120
Technical data.....	120
Trouble shooting	122

Guidelines for safe and efficient use

Please read these simple guidelines. Not following these guidelines may be dangerous or illegal.

Exposure to radio frequency energy

THIS DEVICE MEETS INTERNATIONAL GUIDELINES FOR EXPOSURE TO RADIO WAVES

Your mobile device is a radio transmitter and receiver. It is designed and manufactured not to exceed the limits for exposure to radio frequency (RF) recommended by international guidelines (ICNIRP). These limits are part of comprehensive guidelines and establish permitted levels of RF energy for the general population. The guidelines were developed by independent scientific organisations through periodic and thorough evaluation of scientific studies. The guidelines include a substantial safety margin designed to assure

the safety of all persons, regardless of age and health.

The exposure standard for mobile devices employs a unit of measurement known as the Specific Absorption Rate, or SAR. The SAR limit stated in the international guidelines is 2.0 W/kg*. Tests for SAR are conducted using standard operating positions with the device transmitting at its highest certified power level in all tested frequency bands. Although the SAR is determined at the highest certified power level, the actual SAR of the device while operating can be well below the maximum value. This is because the device is designed to operate at multiple power levels so as to use only the power required to reach the network. In general, the closer you are to a base station, the lower the power output of the device. Before a phone model is available for sale to the public,

compliance with the European R&TTE directive must be shown. This directive includes as one essential requirement the protection of the health and the safety for the user and any other person.

The highest SAR value for this device when tested for use at the ear is 0.564 W/kg.

This device meets RF exposure guidelines when used either in the normal use position against the ear or when positioned at least 1.5 cm away from the body. When a carry case, belt clip or holder is used for body-worn operation, it should not contain metal and should position the product at least 1.5 cm away from your body. In order to transmit data files or messages, this device requires a quality connection to the network. In some cases, transmission of data files or messages may be delayed until such a connection is available. Ensure

the above separation distance instructions are followed until the transmission is completed. The highest SAR value for this device when tested for use at the body is 0.935 W/kg.

* The SAR limit for mobile devices used by the public is 2.0 watts/kilogram (W/kg) averaged over ten grams of body tissue. The guidelines incorporate a substantial margin of safety to give additional protection for the public and to account for any variations in measurements. SAR values may vary depending on national reporting requirements and the network band.

For SAR information in other regions please look under product information at www.lgmobile.com.

Guidelines for safe and efficient use

FCC SAR information

Your mobile device is also designed to meet the requirements for exposure to radio waves established by the Federal Communications Commission (USA) and Industry Canada.

These requirements set a SAR limit of 1.6 W/kg averaged over 1 gram of tissue. The highest SAR value reported under this standard during product certification for use at the ear is 0.216 W/kg and when properly worn on the body is 0.628 W/kg.

Additionally, this device was tested for typical body-worn operations with the back of the phone kept 0.79 inches (2cm) between the user's body and the back of the phone.

To comply with FCC RF exposure requirements, a minimum separation distance of 0.79 inches (2cm) must be maintained between the user's body and the back of the phone.

* FCC Notice & Caution

Notice!

This device complies with part 15 of the FCC Rules. Operation is subject to the following two conditions:

- (1) This device may not cause harmful interference, and
- (2) this device must accept any interference received, including interference that may cause undesired operation.

Caution!

Change or Modifications that are not specifically approved by the manufacturer could void the user's authority to operate the equipment

Product care and maintenance



WARNING

Only use batteries, chargers and accessories approved for use with this particular phone model. The use of any other types may invalidate any approval or warranty applying to the phone, and may be dangerous.

- Do not disassemble this unit. Take it to a qualified service technician when repair work is required.
- Keep away from electrical appliances such as TVs, radios, and personal computers.
- The unit should be kept away from heat sources such as radiators or cookers.
- Do not drop.
- Do not subject this unit to mechanical vibration or shock.
- Switch off the phone in any area where you are required by special regulations. For example, do not use your phone in hospitals as it may affect sensitive medical equipment.
- Do not handle the phone with wet hands while it is being charged. It may cause an electric shock and can seriously damage your phone.
- Do not charge a handset near flammable material as the handset can become hot and create a fire hazard.
- Use a dry cloth to clean the exterior of the unit (do not use solvents such as benzene, thinner or alcohol).
- Do not charge the phone when it is on soft furnishings.
- The phone should be charged in a well ventilated area.

Guidelines for safe and efficient use

- Do not subject this unit to excessive smoke or dust.
- Do not keep the phone next to credit cards or transport tickets; it can affect the information on the magnetic strips.
- Do not tap the screen with a sharp object as it may damage the phone.
- Do not expose the phone to liquid, moisture or humidity.
- Use the accessories like earphones cautiously. Do not touch the antenna unnecessarily.
- Do not use the phone or accessories in places with high humidity such as pools, greenhouses, solariums or tropical environments, it may cause damage to the phone and invalidation of warranty.

Efficient phone operation

Electronic and medical devices

All mobile phones may get interference, which could affect performance.

Do not use your mobile phone near medical equipment without requesting permission. Please consult your doctor to determine if operation of your phone may interfere with the operation of your medical device.

Some hearing aids might be disturbed by mobile phones.

Minor interference may affect TVs, radios, PCs, etc.

Pacemakers

Pacemaker manufacturers recommend that a minimum separation of 15cm be maintained between a mobile phone and a pacemaker to avoid potential interference with the pacemaker. To achieve this use the phone on the opposite ear to your pacemaker and do not carry it in a breast pocket.

Hospitals

Switch off your wireless device when requested to do so in hospitals, clinics or health care facilities. These requests are designed to prevent possible interference with sensitive medical equipment.

Road safety

Check the laws and regulations on the use of mobile phones in the area when you drive.

- Do not use a hand-held phone while driving.
- Give full attention to driving.
- Use a hands-free kit, if available.
- Pull off the road and park before making or answering a call if driving conditions so require.
- RF energy may affect some electronic systems in your vehicle such as car stereos and safety equipment.
- When your vehicle is equipped with an air bag, do not obstruct with installed or portable wireless equipment. It can cause the air bag to fail or cause serious injury due to improper performance.

Guidelines for safe and efficient use

- If you are listening to music while out and about, please ensure that the volume is at a reasonable level so that you are aware of your surroundings. This is particularly imperative when near roads.

Avoid damage to your hearing

Damage to your hearing can occur if you are exposed to loud sound for long periods of time. We therefore recommend that you do not turn on or off the handset close to your ear. We also recommend that music and call volumes are set to a reasonable level.

Glass Parts

Some parts of your mobile device are made of glass. This glass could break if your mobile device is dropped on a hard surface or receives a substantial impact. If the glass breaks, do not touch or attempt to remove. Stop using your mobile device until the glass is replaced by an authorized service provider.

Blasting area

Do not use the phone where blasting is in progress. Observe restrictions, and follow any regulations or rules.

Potentially explosive atmospheres

- Do not use the phone at a refueling point.
- Do not use near fuel or chemicals.
- Do not transport or store flammable gas, liquid, or explosives in the same compartment of your vehicle as your mobile phone and accessories.

In aircraft

Wireless devices can cause interference in aircraft.

- Turn your mobile phone off before boarding any aircraft.
- Do not use it on the ground without permission from the crew.

Children

Keep the phone in a safe place out of the reach of small children. It includes small parts which may cause a choking hazard if detached.

Emergency calls

Emergency calls may not be available under all mobile networks. Therefore, you should never depend solely on the phone for emergency calls. Check with your local service provider.

Guidelines for safe and efficient use

Battery information and care

- You do not need to completely discharge the battery before recharging. Unlike other battery systems, there is no memory effect that could compromise the battery's performance.
- Use only LG batteries and chargers. LG chargers are designed to maximize the battery life.
- Do not disassemble or short-circuit the battery pack.
- Keep the metal contacts of the battery pack clean.
- Replace the battery when it no longer provides acceptable performance. The battery pack maybe recharged hundreds of times until it needs replacing.
- Recharge the battery if it has not been used for a long time to maximize usability.
- Do not expose the battery charger to direct sunlight or use it in high humidity, such as in the bathroom.
- Do not leave the battery in hot or cold places, this may deteriorate the battery performance.
- There is risk of explosion if the battery is replaced by an incorrect type.
- Dispose of used batteries according to the manufacturer's instructions. Please recycle when possible. Do not dispose as household waste.
- If you need to replace the battery, take it to the nearest authorized LG Electronics service point or dealer for assistance.
- Always unplug the charger from the wall socket after the phone is fully charged to save unnecessary power consumption of the charger.

- Actual battery life will depend on network configuration, product settings, usage patterns, battery and environmental conditions.
- Let the person you are speaking with know you are driving; if necessary, suspend the call in heavy traffic or hazardous weather conditions. Rain, sleet, snow, ice and even heavy traffic can be hazardous.

Driver Safety Tips

Your wireless telephone gives you the powerful ability to communicate by voice - almost anywhere, anytime. But an important responsibility accompanies the benefits of wireless phones, one that every user must uphold.

When driving a car, driving is your first responsibility. When using your wireless phone behind the wheel of a car, practice good common sense and remember the following tips:

- Use a hands free device. If possible, add an additional layer of convenience and safety to your wireless phone with one of the many hands free accessories available today.

- ▶ Use your wireless phone to call emergency services for yourself or others.

In the case of fire, traffic accident or medical emergencies;

- Australia: Dial 0-0-0,
- New Zealand: Dial 1-1-1,
- International: Dial 1-1-2,
- other local emergency number.

Remember, it is a free call on your wireless phone for emergency services.

Guidelines for safe and efficient use

- ▶ Use your wireless phone to help others in emergencies, if you see an auto accident crime in progress or other serious emergency where lives are in danger, call the emergency number, as you would want others to do for you.
- Do not take notes or look up phone numbers while driving. Jotting down a “to do” list or flipping through your address book takes attention away from your primary responsibility, driving safely.
- If possible, place calls when you are not moving or before pulling into traffic. Try to plan calls when you will not be driving.
- Do not engage in stressful or emotional conversations that may be distracting. Make people you are talking with aware you are driving and suspend conversations that have the potential to divert your attention from the road.

Getting to know your phone

Handsfree or Stereo earphone connector

Power key

Turns the phone on/off.

Earpiece

Inner camera

Proximity Sensor



WARNING: Putting a heavy object on the phone or sitting on it can damage its LCD and touch screen functionality. Do not cover the protection film on proximity sensor of LCD. It can cause malfunction of sensor.

Getting to know your phone



**Charger, Data cable
(USB cable)**

TIP: Before connecting the USB cable, wait until the phone has powered up and has registered on the network.

Music key



Volume keys

- **When the screen is idle:** key tone or ring tone volume.
- **During a call:** earpiece volume.
- **When playing a track:** controls the volume continuously.

Camera key

- Go to camera menu directly by pressing and holding the key.

Open view

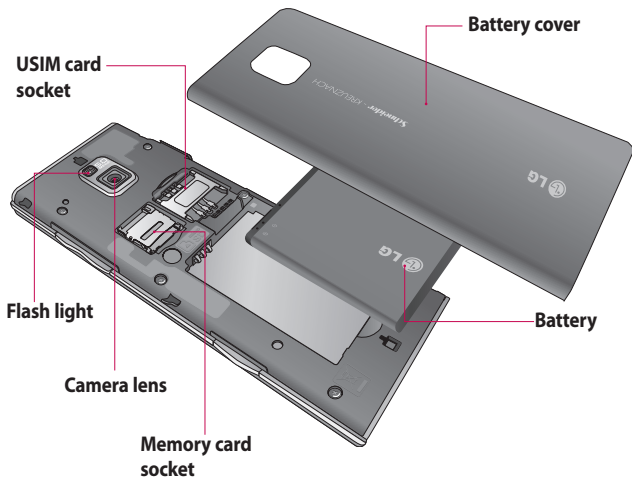

Installing the USIM and battery

1 Remove the battery cover

Slide down the battery cover.



 **WARNING:** Do not remove the battery when the phone is switched on, as this may damage the phone.

2 Remove the battery

Pull out the battery.

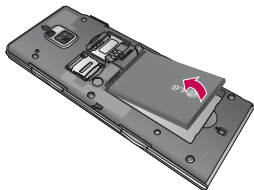

3 Install the USIM card

Slide the USIM card into the USIM card holder. Make sure the gold contact area on the card is facing downwards. To remove the USIM card, gently pull it outwards.

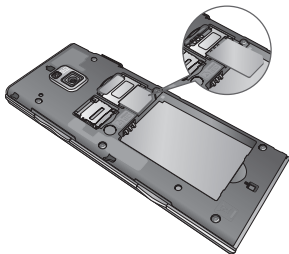

4 Install the battery

Insert the top of the battery into the top edge of the battery compartment first. Ensure that the battery contacts align with the phone's terminals. Press the bottom of the battery down until it clips into place.

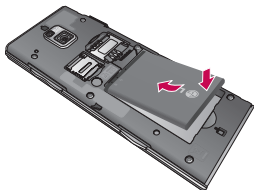

Charging your phone

Open the cover of the charger connector on the side of your BL40. Insert the charger and plug it into a mains electricity socket. Your BL40 must be charged until the “Battery full” message appears on the screen.

NOTE: The battery must be fully charged initially to improve battery lifetime. Disregard the first “Battery full” message and keep the phone on charge overnight (or for up to 14 hours).

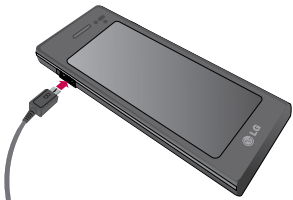

Memory card

Installing a memory card

You can expand the available memory space on your phone by using a memory card (microSD).

NOTE: A memory card is an optional accessory.

Slide the memory card into the slot at the top, until it clicks into place. Make sure the gold contact area is facing downwards.

 **WARNING:** Slide the memory card into the slot, otherwise the card may be damaged.

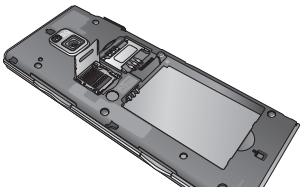
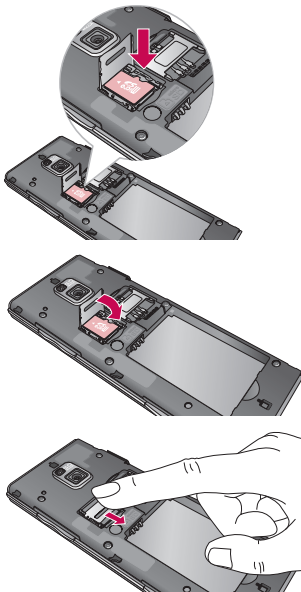

Memory card

Formatting the memory card

Your memory card may already be formatted. If it isn't, you will need to format it before you can start to use it.

NOTE: All files get deleted while formatting.

- 1 From the home screen select  and select **Phone settings** from the Settings tab.
- 2 Scroll and touch **Memory info** then scroll and touch **External memory**.
- 3 Touch **Format** and then confirm your choice.
- 4 Enter the password, if one has been set. The card will then be formatted and ready to use.

NOTE: If there is existing content on your memory card, the folder structure may be different after formatting since all files will have been deleted.

Transferring your contacts









To transfer your contacts from your USIM to your phone:

- 1 From the Communication tab, scroll through **Contacts** and choose  then **Change location**.
- 2 Touch **Copy to Handset**.
- 3 Choose **Mark all** or select names one by one and touch **Copy to Handset**.









Menu map

Touch  in the home screen to open a **Top menu**. From here you can access further menus by scrolling through the icons: **Communication**, **Entertainment**, **Utilities** and **Settings**.







Communication

-  Contacts
-  Recent history
-  Messaging
-  Write message
-  Email
-  Dialling
-  Video call
-  New contact





Entertainment

-  Music
-  Gallery
-  Camera
-  Games
-  Fun stuff
-  My Files
-  FM radio
-  Movie maker

Utilities

-  Vodafone live!
-  Tools
-  Applications
-  Alarms
-  Organiser
-  Voice recorder
-  Calculator
-  Memo

Settings

-  Profiles
-  Phone settings
-  Connectivity
-  Bluetooth
-  Wi-Fi
-  Call settings
-  Display settings
-  Touch settings

Your home screen

From this screen you can access menu options, make a call, view the status of your phone and much more.

Touch screen tips

The home screen is also a great place to get used to using the touch screen.

To select an item, touch the centre of the icon.

- Do not to press too hard; the touchscreen is sensitive enough to pick up on a light, firm touch.
- Use the tip of your finger to touch the option you require. Be careful not to touch any other keys.
- When the screen light is off, press the power key to return to the home screen.

- Whenever your BL40 is not in use, it will return to the lock screen.

Customising the home screen

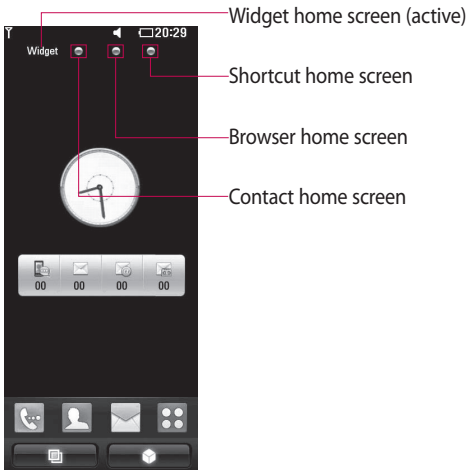

Your home screen

- **Get in touch with your BL40** -
The User Interface is based on four types of Homescreens. To swap between the home screens just wipe quickly over the display from left to right or from right to left.
- **Home screen customisation** -
For each type of home screen you are able to add and remove objects by pressing & holding your finger on the screen, or if already added touching and holding one of the objects.



Quick keys

The quick keys on your home screen provide easy, one-touch access to the functions you use most.



Touch to bring up the touch dialling pad, which lets you make a call. Enter the number as you would with a normal key pad and touch **Voice call**.

To place a video call to this number, touch **Video Call** after entering the number.



Touch to open your contacts. To search for the number you want to call: Click the search icon to enter the name of the contact using the touchpad. You can also create new contacts and edit existing ones.



Touch to access the **Messaging** menu. From here you can create a new SMS.



Touch to open the full top menu which is divided into four sub-menus.

Your home screen

Touch screen

The controls on the BL40 touch screen change dynamically, depending on the task you are carrying out.

Opening Applications

To open any Application simply touch its icon.

Scrolling

Drag from side to side to scroll. On some screens, such as web pages, you can also scroll up or down.



Zooming In or Out



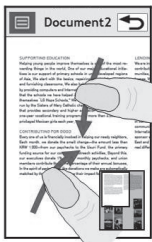





When viewing photos, web pages, emails, or maps, you can zoom in and out. Pinch your fingers together or slide them apart.





















Viewing the status bar



















The status bar uses various icons to show different conditions such as signal strength, new messages and battery life as well as telling you whether Bluetooth or GPRS are active.











Below is a table which explains the meaning of icons you're likely to see in the status bar.

Icon	Description
	No Service
	2G
	3G
	EDGE
	HSDPA
	Wi-fi is on
	Bluetooth Message
	Bluetooth Mono hands free headset
	Bluetooth Mono Stereo headset

Your home screen

Icon	Description
	Bluetooth Stereo headset
	Bluetooth Mono headset
	Bluetooth on
	Printer by Bluetooth
	Bluetooth Transfer
	Bluetooth Visibility
	Bluetooth Music
	Downloading
	Downloading complete
	Downloading cancelled
	In-call option
	Internet
	Searching
	Call divert
	Call reject
	Security
	Headset
	HomeZone
	Roaming

Icon	Description
	Alarm
	Schedule (Calendar)
	Multi-tasking
	Music paused
	Music playing
	Music playing with FM broadcasting
	FM radio playing
	FM broadcasting
	Email being sent
	Email received
	MMS sending has failed
	MMS sending
	MMS receiving
	MMS New message
	SMS sending
	SMS receiving
	New voicemail
	New message

Icon	Description
	SMS sending has failed
	New email
	Push message
	Flight mode
	Normal
	Outdoor
	Silent
	Customised profile 1-10 or Customised 1-10
	External memory
	Battery status
	Microsoft Exchange

Using the Multi-tasking function

Touch the multitasking key  to open the **Multitasking** menu. From here you can view some applications that are running and access them with one touch.





Calls

TIP! Press the power key briefly to lock the touchscreen and prevent calls being made by mistake.



Making a call or a video call

- 1 Touch  to open the keypad.
- 2 Type in the number on the keypad. To delete a digit, press the clear key.
- 3 Touch the **Voice call** or **Video call** to place the call.
- 4 To end the call, touch the **End call**.

TIP! To enter + for making international calls, touch  twice or press and hold down .

TIP! You can **Save number**, **Send message**, **Search contacts** by tapping .

Calling your contacts

- 1 From the home screen touch  to open your **Contacts**.
- 2 Scroll through the contact list or enter the first letter(s) of the contact you want to call by touching .
- 3 From the list, touch the contact you want to call and select the number to use, if there is more than one number for that contact.
- 4 Touch **Voice call** or **Video call**.

Answering and rejecting a call

When your phone rings, touch the **Accept** button to answer the call. Touch the  button to reject an incoming call.

In-call options

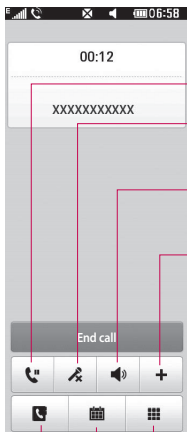



Hold - Touch  to put a call on hold.

Mute - Touch  to turn the microphone off so the person you are talking to cannot hear you.

Speaker - Touch  to turn the speaker phone on.

Options - Choose from a list of further in-call options, including creating new memo and going to messages, so you can check your messages and add contacts during a call. You can also end the call from here by touching End call.

 - Touch to open a numerical keypad for typing in numbers, e.g. when dialling call centres or other automated telephone services.

 - Add a memo during a call.

 - Search your contacts during a call.



Calls

Adjusting call volume

To adjust the volume during a call, use the up and down button on the right side of the phone.

Speed dialling



You can assign a frequently-called contact to a speed dial number.

- 1 From the home screen touch  to open your **Contacts**.
- 2 Touch  and select **Speed dials**.
- 3 Your voicemail is already set to speed dial 1. You cannot change this. Touch any other number to assign it to a speed dial contact.
- 4 Your contacts list will open. Select the contact you want to assign to that number by touching the phone number once.

To call a speed dial number, touch  on the home screen then press and hold the assigned number until the contact appears on the screen.

The call will initiate automatically, without having to touch **Voice call**.

Making a second call

- 1 During your initial call, touch  and select the number you want to call.
- 2 Call the number (unable to search for contacts).
- 3 Touch **Voice call** to connect the call.
- 4 Both calls will be displayed on the call screen. Your initial call will be locked and put on hold.
- 5 Touch the swap icon  to toggle between calls.
- 6 Touch the + symbol to open the in-call menu and select “Join calls” to make a conference call.
- 7 To end one or both calls press  .

NOTE: You will be charged for each call you make.

Turning off DTMF

DTMF lets you use numerical commands to navigate within automated calls. DTMF default is set to on.

To turn it off during a call (e.g. to make a note of a number) touch  and select **Disable DTMF**.

Viewing your call logs

From the home screen, touch , then touch **Recent history** in the Communication tab.

Choose from the following:

All history - View a complete list of all dialled, received and missed calls, voice calls, video calls and messages.

Missed calls - View a list of all calls you have missed.

Calls only - View a list of all calls you have made and missed.

Messages only - View a list of all numbers that have received or sent texts and multimedia messages.

VT only - View a list of all video calls.

TIP! From any call log, touch  and **Delete all** to delete all recorded items.

TIP! Touch any single call log entry to view the date, time and duration of the call.

Calls

Using call divert

- 1 Touch  and choose **Call settings** in the Settings tab.
- 2 Touch **Call divert** and choose **Voice calls** and/or **Video calls**.
- 3 Choose whether to divert all calls, when the line is busy, when there is no answer, or when you cannot be contacted.
- 4 Enter the number to divert to.
- 5 Touch **Activate** to activate.
- 6 Enter the number to divert to.

NOTE: Diverting calls will incur charges. Please contact your network operator for details.

TIP! To turn off all call diverts, select **Deactivate all** from the **Call divert** menu.

Using call barring

- 1 Touch  and choose **Call settings** in the Settings tab.
- 2 Touch **Call barring** and choose **Voice calls** and/or **Video calls**.
- 3 Choose any or all of the five options:
 - All outgoing**
 - Outgoing international**
 - Outgoing international calls except home country**
 - All incoming**
 - Incoming when abroad**
- 4 Enter the call barring password. Please check with your network operator about this service.

TIP! Select **Fixed dial numbers** to turn on and compile a list of numbers that can be called from your phone. You'll need your PIN2 code, available from your operator. Only numbers within the fixed dial list can be called from your phone.

Changing the common call setting

- 1 Touch  and choose **Call settings** in the Settings tab.
- 2 Touch **Common settings**. This lets you amend the following settings:
 - Call reject** - Slide the switch left for **ON**. You can touch the **Reject list** to choose all calls, specific contacts or groups or calls from unregistered numbers (i.e. not in your contacts).

Send my number - Choose whether to display your number on an outgoing call.

Auto redial - Slide the switch left for **ON** or right for **OFF**.

Minute minder - Slide the switch left to **ON** to hear a tone every minute during a call.

BT answer mode - Select **Hands-free** to be able to answer a call automatically while using a Bluetooth headset, or select **Handset** to press a handset key to answer a call.

Save new number - Select **ON** or **OFF** to save a new number.

Voice clarity - Select **ON** or **OFF** to clear noises around. This feature makes your voice louder and clearer.

Calls

Changing your video call settings



- 1 From the home screen, touch  and scroll to **Call settings** in the Settings tab.
- 2 Touch **Video call settings** and select the settings for your video calls. Decide whether to use still image, then select one and/or switch on the mirror to see yourself on screen when making a video call.

Contacts

Searching for a contact

There are two ways to search for a contact:

From the home screen

- 1 From the home screen touch  to open your **Contacts**. Touch  and enter the contact name using the key pad.
- 2 Touch **Video call** or **Voice call** to place the call.

TIP! You can search by group by touching the Contacts tab on the top of the screen and selecting **Groups**. This will bring up a list of all your groups.

From the main menu

- 1 Touch , touch **Contacts** on the Communication tab.

Adding a new contact

- 1 From the home screen touch  then touch **New contact**.
- 2 Choose whether to save the contact to **Handset** or **USIM**.
- 3 If you want to add a picture to each contact, touch **Add picture**.
- 4 Enter the first and last name of your new contact. You do not have to enter both, but you must enter at least one.
- 5 Enter up to five different numbers and assign a type to each of them, choosing between **Mobile**, **Home**, **Office**, **Pager**, **Fax**, **VT** and **General**.
- 6 Add an email address.
- 7 Assign the contact to one or more groups, choosing between **No group**, **Family**, **Friends**, **Colleagues**, **School** or **VIP**.



Contacts

8 You can also add a **Ringtone, Vibration, Homepage, Home address, Company name, Job title, Company address, Birthday, Anniversary** and **Memo**.

9 Touch  to save the contact.

TIP! You can create customised groups for your contacts. See **Creating a group**.

Creating a group

- 1** From the home screen, touch  and then touch **Contacts** in the Communication tab.
- 2** Touch **Contacts** on the top of the screen, then touch **Groups** and select **New group**.
- 3** Enter a name for the new group. And set the group picture, group name, group ringtone and group vibration.
- 4** Touch  to save the group.

NOTE: If you delete a group, the contacts assigned to that group will not be lost. They will remain in your contacts.

TIP! You can edit an existing group by touching the selected group once. Choose **View members, Edit the group, Send message, Send business card** or **Delete group**.

Changing your contact settings

You can adapt your contact settings to suit your own preferences.

- 1** Touch **Contacts** from the Communication tab, select  and scroll through **Contact settings**.
- 2** From here, you can adjust the following settings:
Display name - Choose whether to display the first or last name of a contact first.

Copy - Copy your contacts from your USIM to your handset, or vice versa. You can do this one contact at a time, or all at once.

Move - This works in the same way as Copy, but the contact will only remain in the new location. Therefore, once a contact is moved from the USIM to the handset it will be deleted from the USIM memory.

Clear contacts - Delete all your contacts. Touch **Yes** if you are sure you want to delete all your contacts.

Memory info. - View memory capacity information.

Synchronise contacts - Connect to your server to synchronise your contacts.

Send all contacts via Bluetooth

- Send all of your contacts to another device using Bluetooth. You will be prompted to turn on Bluetooth if you select this option.

Viewing information

- 1 Touch **Contacts** from the Communication tab select  and scroll to **Information**.
- 2 From here you can view your **Service dial numbers**, **Own numbers** and **Memory info.** (memory space remaining).

TIP! To add your own business card, select **My business card** and enter your details as you would for any contact. Touch  to finish.

Messaging

Messaging

Your BL40 combines SMS and MMS into one intuitive, easy to use menu.

There are two ways of entering the messaging centre:

1 From the home screen, touch , or touch  then scroll through **Messaging** from the Communication tab.

Sending a message

1 Touch  then **Write message** to open a blank message.

2 Touch **To** to enter the recipient's number, or open your contacts or favourites. You can add multiple contacts. When you are finished, touch the message box below to start composing the message text.

3 After entering the text, you can send the SMS by touching the send button on top of the message.

TIP! You will be charged for a 160 character text message for every person you send the message to.

4 Touch  **Insert** to add an Image, Video, Sound, SMS template, MMS template, emoticon, name & number, new slide, subject or signature and **More** (Business card/Schedule/Memo/Tasks).

 **WARNING:** The 160-character limit may vary from country to country depending on how the SMS is coded.

 **WARNING:** If an image, video or audio file is added to an SMS, it will automatically be converted to an MMS, and you will be charged accordingly.

Entering text

 Touch to turn on T9 predictive texting.

 Tap to change between the number, symbol and text keypads.

Use  to toggle between the different keyboards in each text entry mode (e.g., capital or lower case letters).

To enter a space, touch .

T9 predictive

In T9 mode, you will see , coloured circle in orange.

T9 uses a built-in dictionary to recognise your words based on the key sequences you touch. Simply touch the number key associated with the letter you want to enter, and the dictionary will predict the word you want to use.

For example, press 8, 3, 5, 3, 7, 4, 6, 6 and 3 to write 'telephone'.

Abc manual

In Abc mode you have to touch the key repeatedly to enter a letter. For example, to write 'hello', touch 4 twice, 3 twice, 5 three times, 5 three more times, then 6 three times.

Messaging

Setting up your email

You can keep in touch on the move using your BL40 to email. It's quick and simple to set up a POP3 or IMAP4.

- 1 Touch  from the home screen, and scroll to **Email** on the Communication tab.
- 2 Touch **Write email**. If the email account is not set up, start the email set up wizard.

TIP! If an email account is already set up, the wizard is not activated automatically.

You can also edit specific account settings by navigating to **Communication > Email >**  **> New email account**. Email provider appears: Vodafone E-M@il, Others.

Vodafone E-M@il

Email address - Enter the account email address.

Password - Enter the account password.

User name - Enter the account username.

Others

Email address

Password

User name

Mailbox type - Select mailbox type POP3 or IMAP4.

Incoming server - Enter the incoming email server address.

Outgoing server - Enter the outgoing email server address.

SMTP authentication - Choose the security settings for the outgoing mail server.

SMTP Username - Enter the SMTP username.



SMTP Password - Enter the SMTP password.

Account name - Enter a name for this account.

Once the account is set up, it will appear in the accounts list in your Email folder.

Retrieving your email

You can automatically or manually check your account for new emails. To check manually:

- 1 Touch  from the home screen, and scroll through **Email** from the Communication tab.
- 2 Select **Email**.
- 3 Touch the account you want to use then .
- 4 Choose Retrieve/Message synchronisation and your BL40 will connect to your email account and retrieve your new messages.

Sending an email using your new account



- 1 Touch  from the home screen, and scroll to **Email** on the Communication tab and touch **Write email** to open a new blank message.
- 2 Enter the recipient's address and write your message. You can also attach images, videos, audio files and other file types.
- 3 Touch **Send email** to send your email.

TIP! During an active Wi-Fi connection, emails are sent and received via Wi-Fi.

Messaging

Changing your email settings

You can change your email settings based on your own preferences.

- 1 Touch  from the home screen, and scroll through **Email** from the Communication tab.
- 2 Select  and scroll to **Email settings**.
- 3 You can alter the following settings:

Email accounts - Manage your email accounts.

Allow reply email - Choose whether to allow read confirmation messages to be sent.

Request reply email - Choose whether to request read confirmation messages.

Retrieve interval - Select how often your BL40 checks for new email messages.

Retrieve amount - Select how many your BL40 checks for new email messages.

Include message in fwd & reply

- Select whether to include the original message in your reply.

Include attachment - Select whether to include the original attachment in any reply.

Auto retrieval in roaming - Choose whether to retrieve messages automatically when abroad (roaming).

New email notification - Choose whether to be alerted about a new email without a pop-up message.

Signature - Create an email signature and switch this feature on.

Priority - Choose the priority level of your email messages.

Mail sending size - Choose the size of email you send.

Message folders

You will recognise the folder structure in your BL40, which is fairly self-explanatory. If you set up an email account, you can have folders for each account.

Inbox - All messages you receive are stored in your inbox. From here you can view them and delete them, amongst other functions.

Outbox - This is a temporary storage folder while messages are being sent.

Sent items - Messages you send are stored in this folder.

Drafts - If you don't finish writing a message you can save what you've done in this folder.

Threaded box - Messages (SMS, MMS) exchanged with another party can be displayed in chronological order so that you conveniently can see an overview of your conversation.

My folders - Create folders to store your messages.

Using templates

Create templates for the SMS and MMS messages you send most often. There are already some templates on the phone, which you can edit.

- 1 When writing a new message, you can enter **Templates** from **Insert** in option menu.
- 2 Choose **SMS Template** or **MMS Template**. You can then touch  to **New template**, **Delete** or **Delete all** templates. To edit a message just select it, make your changes and touch **Save**.

Messaging

Using emoticons

Liven up your messages using emoticons. There are some commonly used emoticons already on your phone.

- 1 When writing a new message, you can enter **Emoticon** from **Insert** in the options menu.
- 2 You can add a new emoticon by touching **New emoticon**.

Changing your text message settings

Your BL40 message settings are pre-defined, so you can send messages immediately. These settings can be changed based on your preferences.

Scroll through **Messaging** from the Communication tab. Touch  then choose **Message settings** and **Text message**. You can change the following:

Text message centre - Enter the details of your message centre.

Delivery report - Slide the switch left to receive confirmation that your messages have been delivered.

Validity period - Choose how long your messages are stored at the message centre.

Message types - Convert your text into **Voice, Fax, X.400** or **Email**.

Character encoding - Choose how your characters are encoded. This impacts on the size of your messages and therefore on your data charges.

Send long text as - Choose to send long messages as Multiple SMS or MMS.

Signature - Select to add signature in the text message.

Changing your multimedia message settings

Your BL40 message settings are pre-defined, so you can send messages immediately. These settings can be changed based on your preferences.

Scroll through **Messaging** from the Communication tab. Touch  then choose **Message settings** and **Multimedia message**. You can make change the following:

Retrieval mode - Select **Home network** or **Roaming network**. If you then select Manual you will only receive notifications about MMS messages. You can then decide whether to download them in full.

Delivery report - Choose whether to allow and/or request a delivery report.

Read reply - Choose whether to allow and/or send a read reply.

Priority - Choose the priority level of your MMS.

Validity period - Choose how long your message is stored at the message centre.

Slide duration - Choose how long slides appear on screen.

Creation mode - Choose the mode between restricted/Warning/Free.

 **WARNING:** You can select to restrict or attach unsupported type files to MMS via confirmation popup.

Free - It can attach the unsupported type file to MMS up to the available size.

Delivery time - Choose how long to wait before a message is delivered.

Multimedia message centre - Enter the details of your message centre.

Messaging

Changing your other settings

Scroll through **Message settings** from the Settings tab then:

Service message - Choose whether to receive or block service messages. You can also set message security levels by creating trusted and not trusted sender lists.

Save sent message - Choose whether to save or not save for sent message.

Info. service - Select your reception status, language and other settings.

Camera

Taking a quick photo

- 1** Press and hold down the Camera key on the right side of the phone.
- 2** Holding the phone horizontally, point the lens towards the subject you want to take a picture of.
- 3** Press the capture button lightly and a focus box will appear in the centre of the viewfinder screen.
- 4** Position the phone so you can see the photo subject in the focus box.
- 5** When the focus box turns green, the camera has focused on your subject.
- 6** Press the capture button and hold it down.

Camera

Once you've taken the photo

Your captured photo will appear on the screen. The image name is shown with eight options on the sides.



Send Touch to send the photo as a **Message, Email, Bluetooth** or **Postcard**.

NOTE: Additional cost may occur when MMS are sent while roaming.

Use as Touch to use the image as Homescreen, Lock screen, contact picture or start-up screen.

Rename Touch to edit the name of the selected picture.

Edit Touch to edit the image using various tools.



Return Touch to return to the previous menu.

Delete Touch to delete the image.

New picture Touch to take another photo immediately. Your current photo will be saved.

Gallery Touch to view a gallery of your saved photos.

Getting to know the viewfinder

Zoom - Touch  to zoom in or  to zoom out. Alternatively you can use the side volume keys.

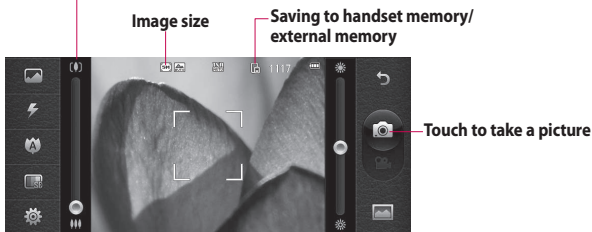

Brightness - See Adjusting the Brightness.

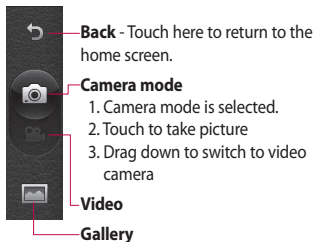
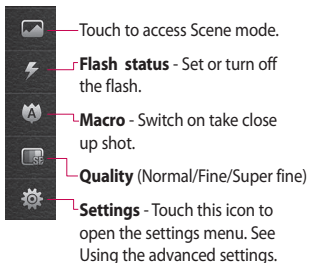

Camera

Using the flash

The default flash setting is auto, but there are other options.

- 1 Select  from the left side of the viewfinder to enter the flash sub-menu.
- 2 There are three flash options:
 - Auto** - Your camera will assess the light available for a good picture and use the flash as necessary.
 - Red -eye reduction** - The camera will flash twice in order to remove red eye.
 - Always off** - The camera will never flash. This is useful if you want to save battery power.
 - Always on** - The camera will always flash.
- 3 When you touch the option you want, the flash menu will automatically close, allowing you to take a picture immediately.

- 4 The flash status icon in the viewfinder will change based on the new flash mode.

Choosing a shot type

- 1 Touch  and select **Shot mode** to open the available shot types
- 2 Choose from eight options:
 - Normal shot** - This is the default shot type, the photo will be taken in the normal way, as outlined in taking a quick photo.
 - Continuous shot** - This enables you to take six shots automatically in very quick succession.
 - Stitch shot** - This enables you to stitch photos side by side after continuous shot. Six to eight pictures can be merged together in a panoramic image, allowing you to enjoy the full size of your BL40's screen.

Smile shot - This shot type is great for taking a photo of people.

Beauty shot - This enables you to take a photo of person's face clearly and brightly. Especially useful when you are close up.

Art shot - Choose different picture effects. (Original, Black&White, Warm, Cold.)

Frame shot - Choose from one of the fun frames to transform your friend or just decorate their surroundings.



Panorama - This shot type is great for taking a photo of a large group of people or for capturing a panoramic view.

Out focusing shot - This shot type means selective focusing. You can focus on the center of image.

Taking a continuous shot

- 1 Touch  and select **Shot mode** to open the available shot types and select **Continuous shot**.
- 2 Position the subject in the viewfinder and press the capture button as if taking a normal photo.
- 3 The camera will take shots in quick succession.

Using the advanced settings

From the viewfinder, touch  to open all advanced settings options. You can change the camera setting by scrolling the wheel. After selecting the option, touch the  button.

TIP! You can view the help menu about the functions of the camera by touching .

Camera

Swap cam - For self portraits, switch to the LG BL40's inner camera. You can also switch between camera mode and video camera mode.

Size - Change the size of the photo to save on memory space or to take an appropriately sized picture for a contact. See **Changing the image size**.

Scene mode - Set the camera to adjust to the environment. Choose from Auto, Portrait, Landscape, Sport and Night.

Colour Effect - Choose a colour tone to use on your new photo. See **Choosing a colour effect**.

White balance - Choose between **Auto, Incandescent, Sunny, Fluorescent** and **Cloudy**.

Self-timer - The self-timer allows you to set a delay after the shutter is pressed. Select **Off, 3 seconds, 5 seconds** or **10 seconds**. This is

ideal if you want to be included in a photo.

Shot mode - Choose the shot mode.

ISO - The ISO rating determines the sensitivity of the camera's light sensor. The higher the ISO, the more sensitive the camera will be. This is useful in darker conditions when you can't use the flash. Select the ISO value from **Auto, 100, 200, 400**, or **800**.

Quality - Choose between Super fine, Fine and Normal. The finer the quality the sharper the photo. However, the file size will increase as a result, which means you'll be able to store fewer photos in your memory.

Memory - Choose whether to save your photos to the **Handset memory** or the **External memory**.

Image stabilization - Enables you to take a picture without the camera wobbling or shaking.

Focus Mode - Select the way the camera will focus. Choose between **Spot**, **Manual focus** and **Face tracking**.

Shutter sound - Select one of the 3 shutter sounds.

Grid screen - Choose between **Off**, **Simple cross** or **Trisection**.

Geo-Tagging - Choose to switch on the EXIF information for the photo to write GPS information.

Reset settings - Restore all camera settings.

TIP! When you exit the camera, all settings will return to their defaults except image size and image quality. Any non-default settings will need to be reset, such as colour tone and ISO. Check these before you take your next photo.

TIP! The settings menu is superimposed over the viewfinder, so when you change elements of the image colour or quality you will see a preview of the image change behind the settings menu.



Camera

Changing the image size

The more pixels, the larger the file, which means the files take up more memory space. If you want to store more pictures on your phone, you can alter the number of pixels to make the files smaller.

- 1 Using the viewfinder, touch  in the left corner.
- 2 Select **Size** from the Preview menu.
- 3 Select a pixel value from the options (**5M(2560x1920)**, **3M(2048x1536)**, **2M(1600x1200)**, **1M(1280x960)**, **VGA(640x480)**, **QVGA(320x240)**, **Contacts**) or choose the predefined wallpaper size.

Choosing a colour effect

- 1 Using the viewfinder, touch  in the left corner.
- 2 Select **Colour Effect** from the Preview menu.
- 3 There are colour tone options.
- 4 When you've made your selection the colour tone menu can be closed by selecting the  ready for you to take your picture.

TIP! You can change a picture taken in colour to black and white or sepia, but you cannot change a picture taken in black and white or sepia to colour.

Using the secondary camera

Your LG BL40 has an inner 640x480 camera for both video calls and taking photos.

- 1 To switch to the secondary camera touch  then select **Use main camera** from the **Swap cam** menu.
- 2 After a few seconds you'll see yourself in the viewfinder. To capture the image, press the side button as normal.

TIP! The secondary camera has fewer settings as it has no flash nor ISO. You can still alter the image size, colour effect, image quality, white balance and set the self-timer by touching  in the same way as when using the main camera.







- 3 After you've taken the photo you'll be offered all the same options as for an image taken with the main camera.
- 4 To return to the main camera touch  and then select **Use secondary camera** from the **Swap cam** menu.

Viewing your saved photos

- 1 You can access your saved photos from within camera mode. Just touch  and your gallery will appear onscreen.

Video camera

Shooting a quick video

- 1 Press and hold the camera key on the right side of the phone.
- 2 Alternatively, draw down  in the view finder in camera mode to switch to video mode.
- 3 The video camera's viewfinder will appear on screen.
- 4 Holding the phone horizontally, point the lens towards the subject of the video.
- 5 Press the capture button once or touch  in the view finder to start recording.
- 6  **REC** will appear at the bottom of the viewfinder with a timer showing the length of the video.
- 7 To pause the video, touch  and resume recording by selecting .
- 8 Touch  on the screen to stop recording.

 **WARNING:** The great editing software on your LG BL40 is compatible with all video types except 640x480. Don't record in this format if you plan to edit the video.

After taking a video

A still image representing your captured video will appear on the screen. The name of the video will be shown on the bottom of the screen, along with nine options on the sides.

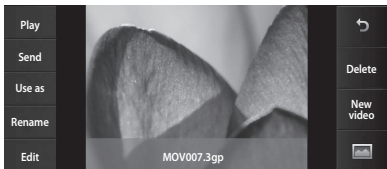

Play Touch to play the video.

Send Touch to send the photo as a **Message**, **Email** or **Bluetooth**. See Sending a message, and Sending and receiving your files using Bluetooth.

Use as Touch to use the video as a ringtone.

Rename Touch to edit the name of the selected picture.

Edit Touch to edit the image using various tools.

 Touch to return to the previous menu.



Delete Touch to delete the video you have just made, and confirm by touching **Yes**. The viewfinder will reappear.

New video Touch to shoot another video immediately. Your current video will be saved.





 Touch to view the saved videos and pictures gallery.

Video camera

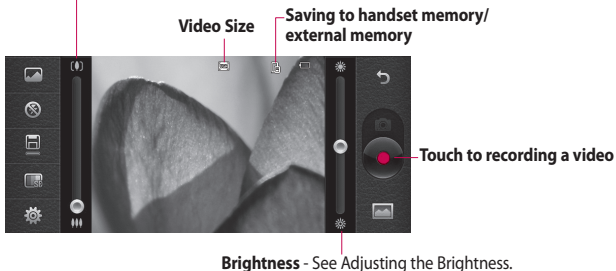
Getting to know the viewfinder

Zoom - Touch  to zoom in or  to zoom out. Alternatively you can use the side volume keys.



-  Touch to access Scene mode.
-  **Flash status** - Set or turn off the flash.
-  **Duration** - Set a duration limit for your video. Choose between Normal and MMS to limit the maximum size to send the video as an MMS.
-  **Quality** - Choose between Super fine, Fine and Normal. The finer the quality, the sharper the video will be. The file size will increase as a result, meaning you'll be able to store fewer videos in the phone's memory.
-  **Settings** - Touch this icon to open the settings menu. See Using the advanced settings.

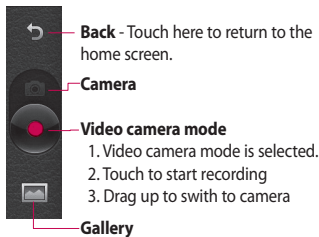

Using the advanced settings

Using the viewfinder, touch  to open all the advanced settings options.

Swap cam - Switch to your LG BL40's inner camera to record yourself on video.

Video size - Change the size of the video to save memory space. See **Changing the video image size.**

Scene mode - Choose between Auto or Night.

Colour Effect - Choose a colour tone to use on your new view. See **Choosing a colour tone.**

White balance - The white balance ensures all white in your video is realistic. To enable your camera to adjust the white balance correctly, you may need to determine the light conditions. Choose between **Auto, Incandescent, Sunny, Fluorescent** or **Cloudy.**

TIP! If you choose MMS duration, choosing a lower image quality will enable you to shoot a longer video.

Memory - Choose whether to save your videos to the Handset memory or the External memory.

Voice - Choose from Mute to record a video without sound, or unmute to include the sound.

Reset settings - Reset all the video camera settings.

Video camera

Changing the video image size

The more pixels, the larger the file size, which means the files take up more memory space. If you want to store more videos on your phone, you can alter the number of pixels to make the files smaller.

- 1 Using the viewfinder, touch  in the left corner.
- 2 Select **Video size**.
- 3 Select a pixel value from the four options:
VGA(640x480) - Standard sized VGA.
QVGA(320x240) - Smaller image size, and therefore a smaller file size. This is ideal for saving memory space.
QCIF(176x144) - Smallest image size and therefore the smallest file size.

- 4 Touch  to return to the viewfinder.

 **WARNING:** The great editing software on your LG BL40 is compatible with all video types except 640x480. Don't record in this format if you plan to edit the video.

TIP! For video format conversion software, see the CD that came with your BL40.

Choosing a colour tone

- 1 Using the viewfinder,  in the left corner.
- 2 Select **Colour Effect**.
- 3 There are five colour tone options, **Off**, **Sepia**, **Monochrome**, **Negative** or **Sketch**.
- 4 Touch the colour tone you want to use.

TIP! You can change a video shot in colour to black and white or sepia, but you cannot change a video shot in black and white or sepia to colour.

Using the secondary video camera



Your LG BL40 has an inner 320x240 camera for both video calls and recording videos.

- 1 To switch to the inner camera, touch  then select **Use secondary camera** from the **Swap cam** menu.
- 2 After a few seconds you'll see yourself in the viewfinder. To start recording the image press the capture button as normal, and press it again to stop recording.

- 3 After you've shot the video, you'll be offered all the options available for a video shot using the main camera.
- 4 To return to the main camera touch  and then **Use main camera**.

TIP! You can still alter the image size, colour effect, white balance and quality by touching **Settings** in the same way as when using the main camera.

Watching your saved videos

- 1 In the viewfinder, touch .
- 2 Your gallery will appear on the screen.
- 3 Touch the video you want to view once to bring it to the front of the gallery. Touch  for it to play.

Video camera

Watching your videos on TV

Connect your BL40 to TV using the TV output cable.

NOTE: The TV output cable is available for purchase separately.



WARNING: All formats except 320x240 and 176x144 are compatible with playing the video through a TV.

Your photos and videos

Viewing your photos and videos

- 1 Touch  on the camera preview screen.
- 2 Your gallery will appear on the screen.
- 3 Touch the video or photo to open it fully.

TIP! Flick left or right to view other photos or videos.

TIP! To delete a photo or video, open it and select . Touch **Yes** to confirm.

Using zoom when viewing a video or photo

When viewing photos or videos, you can zoom in and out by pinching your fingers together or spreading them apart.

Adjusting the volume when viewing a video

To adjust the volume of a video while it is playing, touch the volume button on the bottom right corner of the screen (or the bar on the left side of the screen if the phone is tilt in landscape mode). Alternatively, use the volume keys on the side of the phone.

Your photos and videos

Setting a photo as wallpaper

- 1 Touch the photo you want to set as wallpaper to open it.
- 2 Touch the  to open the options menu
- 3 Touch **Use as**.

Editing your photos

You can do lots of great things to your photos to change them, add to them or liven them up.

- 1 Open the photo you want to edit, and touch the options icon to select **Edit**.
- 2 Touch the icons to alter your photo:



Select Area

I. **Rectangle**

Select a rectangular area and perform the following operation.

1. Crop / Save

Crop area and move your finger across the screen to select the area.

2. Filter

Selected area will be applied.

II. **Ellipse / Circular**

Select a circular area and perform the following operation.

1. Filter

Selected area will be applied.

III. **Photo ID**

Photo Id feature helps you to create your 3x4, 3.5x4.5, 5x7, Contact Image size photo for printing.

 Draw something on your photo, freehand. Select the line thickness from the four options, then the colour you want to use.

 Adding writing on a picture. See **Adding text to a photo**.

 Decorate your photo with stamps. Choose from the different stamps and touch your photo where you want to place them.

 Erase the editing you have done to the picture. You can choose the size of eraser you use.

 Touch to return to the gallery.

 Save the changes you made to the photo. Select to save the changes as an **Update existing**, or a **New file**. If you select **New file** enter a file name.

 Erase the editing you have done to the photo.

 Touch to open further effect options including **Rotate**. There are also more advanced editing options. See **Adding a colour accent** and **Swapping the colours in a photo**.

 Touch to apply the effect options to a photo.

 This helps to adjust a picture taken using automatic colour, brightness etc.





Your photos and videos

Adding text to a photo



- 1 From the editing screen, touch .
- 1 Select **Signature Text** or **Bubble Text**.
- 2 Type the text using the keypad and touch the Save icon.
- 3 Set the text to the desired location on the picture by sliding it.
Touch the text, keypad will be enabled for reedit.



Adding an effect to a photo

- 1 From the editing screen, touch .
- 2 You can apply any of the various options to the photo
- 3 To undo an effect simply touch .

Cropping a photo

- 1 From the editing screen, touch .
- 2 Choose the shape you want to use to crop the picture.
- 3 Drag the box over the area you want to crop.
- 4 When you are happy with your selection, touch .

Adding a colour accent to a photo

- 1 From the editing screen, touch **Image** .
- 2 Choose **Colour Accent**.
- 3 Select part of the photo. A traced line will appear around everything in that area which is the same or a similar colour, for example, a person's hair or jumper.
- 4 Alter the intensity of the accenting by touching **Intensity** and touch '+' or '-' button.
- 5 Touch **OK**.
- 6 All colour will be removed from the photo, apart from in the section marked for colour accenting.
- 7 Select **Save** to save the changes.

Swapping colours in a photo

- 1 From the editing screen, touch **Image** .
- 2 Choose **Colour Swapping**.
- 3 Select part of the photo. A traced line will appear around everything in that area which is the same or a similar colour, for example, a person's hair or jumper.
- 4 Select a colour.
- 5 Press **OK**.
- 6 The part of the photo selected for colour accenting will change to the selected colour.
- 7 Select **Save** to save the changes.

Your photos and videos

Fog Drawing

- 1 Tasks Fog drawing on your picture, touch Image.
- 2 Choose **Fog Drawing**.
- 3 Puff into the mic to put fog on the picture and draw with your finger over it.
- 4 After the fog is applied on the picture, you can change color and intensity of the fog and erase width.

Rain Drop

- 1 For adding rain drops on your picture, select Image menu.
- 2 Choose **Rain Drop**.
- 3 The bubbles appears over the image.
- 4 You can set the intensity/scale of droplets by adjusting the intensity/scale menu bar respectively.
- 5 Also the direction of droplets can be adjusted with the cell phone rotation.

MotionBlur

- 1 For applying Motion Blur, touch **Image**.
- 2 Select **MotionBlur**.
- 3 Select the location you want to enter MotionBlur by drawing an outline. Touch Ok, and then Rub in the direction you want.
- 4 Intensity of the blur can be set using the intensity adjust bar.



Artistic Effect

- 1 From the editing screen, touch **Filter**.
- 2 choose **Artistic Effect**.
- 3 Select the Artistic Effect effect and you can watch the painting.
- 4 The painting will be created and automatically saved. Touch cancel to stop in between.

Editing your videos

The video editing features are available for MPEG4 types.

Trimming the length of the video

- 1 Play the video you want to edit, touch  option key.
- 2 Select **Edit** and choose **Trim/Multi-trim**.
- 3 Touch  and set the new start and end points using **Trim**.
- 4 Touch **Preview** to confirm you are happy with the new cut.
- 5 Touch **Save** or, alternatively, touch  to return to the gallery and discard the changes.



Your photos and videos



Merging two videos

- 1 Play the video you want to edit, touch  option key.
- 2 Select **Edit** and choose **Video merge**.
- 3 The My videos folder will open. Choose the video you want to merge.
- 4 Touch and slide the photo to move it to the end or the beginning of the video.
- 5 Touch **Preview** to choose how to merge the videos together.
- 6 Press **Save** then **Yes** to save the new merged video. Replace the existing file or save as a new file.
- 7 Repeat these steps to merge more videos.



Merging a photo with a video

- 1 Play the video you want to edit, touch  option key.
- 2 Select **Edit** and choose **Image merge**.
- 3 The Images folder will open. Choose the photo you want to merge into your video and touch **Select**.
- 4 Touch and slide the photo to move it to the end or the beginning of the video.
- 5 Touch **Preview** to choose how the photo and video merge together.
- 6 Press **Save** then choose to replace the existing file or save as a new file.
- 7 Repeat these steps to merge more photos.

Adding text to a video

- 1 Open the video you want to edit, touch  option key.
- 2 Select **Edit** and select **Text overlay**.
- 3 Touch  and pause playback for setting the start point for text appearance.
- 4 Touch **Start** and choose the text styles. Enter your text using the keypad and select **OK**.
- 5 Touch the area of the screen you want the text to appear and touch **OK**.
- 6 Touch **Save**. Replace the existing file or save as a new file.
- 7 Repeat these steps to add more text.

Overlaying a photo

- 1 Open the video you want to edit, touch  option key.
- 2 Select **Edit** and choose **Image overlay**.
- 3 The Images folder will open. Choose the photo you want to overlay on your video.
- 4 Touch  and pause when you want the picture to appear, then select **Opacity** after touching the **Start** button.
- 5 Touch **OK** and then press **End** when the photo overlay shall be stopped.
- 6 Touch the area of the screen where you want the text to appear. If the photo is too big it will overlay the whole screen, not just the selected area.
- 7 Touch **Save**. Replace the existing file or save as a new file.
- 8 Repeat these steps to add more photos.

Your photos and videos

Adding a soundtrack to your video

- 1 Open the video you want to edit, touch  option key.
- 2 Select **Edit** and choose **Audio dubbing**.
- 3 The My sounds folder will open. Choose the track you want to add to your video.
- 4 The original audio track on your video will be erased.
- 5 If the audio track is shorter than the video choose whether to play it **Once** or to **Repeat** it.
- 6 Replace the existing file or save as a new file.

Adding live sound to your video

- 1 Open the video you want to edit, touch  option key.
- 2 Select **Edit** and choose **Live dubbing**.
- 3 Set the audio mixing ratio between the original sound and the recording sound.

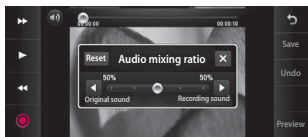

Adding a dimming effect

- 1 Open the video you want to edit, touch  option key.
- 2 Select **Edit** and choose **Dimming Effect**.
- 3 Your video will now fade in at the start and fade out at the end.
- 4 Replace the original file or save as a new file.

Multimedia

You can store multimedia files in your phone's memory so you have easy access to all your pictures, sounds, videos and games. You can also save your files to a memory card. Using a memory card allows you to free up space in your phone's memory.

To access the Entertainment menu, touch  select **My Files** from the Entertainment Tab. You can open a list of the folders that store all your multimedia files.

TIP! To delete any files in My Files, touch  then **Delete**.

Pictures

Images contains a list of pictures including default images pre-loaded onto your phone, images you have downloaded and those taken with your phone's camera.

Images options menu



The options available to you in **Images** depend on the image type you have selected. All of the options will be available for pictures you have taken with the phone's camera, but only the **Set favorites**, **Sort by** and **Slide show** options are available for default images.

Sending a photo

- 1 To send a photo just select the picture you want.
- 2 Touch **Send**. Choose between **Message**, **Email**, **Bluetooth** or **Upload to web**.
- 3 If you choose **Message** or **Email**, your photo will be attached to a message and you can write and send the message as usual. If you choose **Bluetooth**, your phone will search for a device to send the picture to.

Using an image

You can choose images to use as wallpapers and screensavers, or even to identify a caller.

- 1 Touch  then select **My Files** from the Entertainment tab.
- 2 Touch **Images**.
- 3 Select an image and touch .
- 4 Touch **Use as** and choose between:

Homescreens -

Lock screen - Set a wallpaper for the key lock screen.

Contacts image - Allocate an image to a person in your contacts list, so the picture is displayed when they call you.



Start up image - Set an image to appear when you switch the phone on.

Shut down image - Set an image to appear when you switch the phone off.

Outgoing call image - Set an image to appear during outgoing calls.

Incoming call image - Set an image to appear during incoming calls.



Printing an image

- 1 Touch  then select **My Files** from the Entertainment tab.
- 2 Touch **Images**.
- 3 Select an image and touch .
- 4 Touch **Print via Bluetooth**.

Multimedia



Moving or copying an image

An image can be moved or copied between the phone memory and the memory card. You may want to do this to clear some space in one of the memories, or to safeguard your images against being lost.

- 1 Touch  then select **My Files** from the Entertainment tab.
- 2 Touch **Images**.
- 3 Touch .
- 4 Select **Move** or **Copy**.

Creating a slide show

If you want to view all the images on your phone, you can create a slide show to save you having to open and close each individual image.

- 1 Touch  then select **My Files** from the Entertainment tab.
- 2 Touch **Images**.
- 3 Touch  then **Slide show**.

Geo-tagging

Turn on the camera and enjoy the capabilities of your phone's location-based services.

Take pictures wherever you are and tag them with the location.

If you upload tagged pictures to a blog that supports Geo-tagging, you can see the pictures displayed on a map.

Sounds

The **Sounds** folder contains Downloaded sounds, **Default sounds** and **Voice recordings**.

From here you can manage or send sounds or set them as ringtones.

Using a sound

- 1 Touch  then select **My Files** from the Entertainment tab.
- 2 Touch **Sounds**.
- 3 Select **Default sounds** or **Download sound**.
- 4 Select a sound and eventually touch the play icon. It will start to play.
- 5 You can use the sound as a various tone by selecting **Use as** menu.
- 6 Choose between **Ringtone**, **Video ringtone** and **Message tone**.

Videos

The **Videos** folder shows a list of videos you have downloaded or recorded on your phone.

Watching a video

- 1 Touch  then select **My Files** from the Entertainment tab.
- 2 Touch **Videos**.
- 3 Select a video to play.

TIP! BL40 supports both DivX & Xvid video format playback to ensure greater content availability.

NOTE: The TV output cable is available for purchase separately.

Multimedia

Sending a video clip

- 1 Select a video and touch  .
- 2 Touch **Send** and choose between **Message**, **Email** and **Bluetooth**.
- 3 If you choose **Message** or **Email**, your video clip will be attached to the message, which you can write and send as normal. If you choose **Bluetooth**, your phone will search for a device to send the video to.

Games and Applications

You can download new games and applications to your phone to keep you entertained in your free time.

Playing a game

- 1 Touch  then select the **Games** or the **My Files** from the Entertainment tab.
- 2 Touch **Games or Applications** menu.
- 3 Touch Launch button to launch a game or an application.

Using the options menu

Within Games and Application folders, the following options are available:

- Sort by:** Sort the games and applications by Date, Size or Name.
- Original size and Fit to width :** The **Original size** allows an application to be executed in its original resolution. The **Fit to width** allows an application to be executed in a format fitting the whole screen width.

Installing a Java game and application

- 1 Touch  then select **My Files** from Entertainment tab.
- 2 Touch the All Memory item that is upper side menu.
- 3 Select All memory or Phone Memory. If you insert new memory card, touch External Memory menu.

Use the M-Toy menu

M-Toy contains preloaded flash games which are using the integrated motion sensor.

Flash contents

The Flash contents folder contains all downloaded SWF and SVG files.

Viewing an SWF/ SVG file

- 1 Touch  then select **My Files** from the Entertainment tab.
- 2 Touch **Flash contents**.
- 3 Select the file you want to view.

Documents

This is possible with your Excel, PowerPoint, Word, Text and pdf files.

Viewing a file

- 1 Touch  then select **My Files** from the Entertainment tab.
- 2 Touch **Documents**.
- 3 Select a document and touch **View**.

Multimedia

Transferring a file to your phone

Bluetooth is probably the easiest way of transferring a file from your computer to your phone. You can also use the LG PC Suite via your sync cable.

To transfer files (e.g. music) using Bluetooth:

- 1 Make sure your phone and computer have Bluetooth switched on and are connected to each other.
- 2 Use your computer to send the file via Bluetooth.
- 3 When the file is sent, accept it on your phone by touching **Yes**.
- 4 The file should appear in your **Documents** or **Others** folder.

Others

The **Others** folder is used to store files that are not pictures, audio files, videos, games or applications. It is used in the same way as the **Documents** folder. You may find that when you transfer files from your computer to your phone that they appear in the **Others** folder. If this happens, you can move them.

Creating a movie

- 1 Touch  then select **Movie maker** from the Entertainment tab.
- 2 Touch **Insert** to add an image.
- 3 Touch the style to choose a movie style.
- 4 Touch the **Sound** on the screen to change the sound, e.g. for a voice recording.
- 5 Touch the **Preview** button to see the results.

- 6 Touch the **Play Order** on the screen to change the order.
- 7 Touch the **Storage** tab on the screen to choose where to save the movie, and touch the Usage to choose between normal file size and MMS.
- 8 To save your movie, touch **Save movie**.

Music

Your LG BL40 has a built-in music player that lets you play all your favourite tracks. To access the music player, touch menu key  then select **Music** from the Entertainment Tab. From here, you can access a number of folders:

All tracks - Contains all the tracks you have on your phone.

Favorites - Contains the tracks you have saved as favourites.

Artists - Browse your music collection by artists.

Albums - Browse your music collection by albums.

Genres - Browse your music collection by genres.

Playlists

TIP! BL40 is the first worldwide handset to apply Dolby Mobile for music, Providing trademark Dolby sound quality to your mobile phone.

Multimedia

Transferring music onto your phone

The easiest way to transfer music onto your phone is via Bluetooth or the sync cable.

You can also use the LG PC Suite. To transfer music using Bluetooth:

- 1 Make sure both devices have Bluetooth switched on and are connected to each other.
- 2 Select the music file on the other device and select to send it via Bluetooth.
- 3 When the file is sent, accept it on your phone by touching **Yes**.
- 4 The file should appear in **Music** > **All tracks**.

Playing a song

- 1 Touch  then select **Music** from the Entertainment tab.
- 2 Touch **All tracks**.
- 3 Select the track you want to play then touch .
- 4 Touch  to pause the track.
- 5 Touch  to skip to the next track.
- 6 Touch  to go back to the previous track.
- 7 Touch  to return to the **Music** menu.

TIP! To change the volume while listening to music, touch .

Creating a playlist



You can create your own playlists by choosing a selection of songs from the **All tracks** folder.

- 1 Touch  then select **Music** from the Entertainment tab.
- 2 Access the folder Playlists.
- 3 Touch **New playlist**, enter the playlist name and touch .
- 4 The All tracks folder will be displayed. Touch all the songs that you would like to include in your playlist; a tick will appear next to these track names.
- 5 Touch **Add songs**.

To play a playlist, select it and touch one of the tracks it contains.

NOTE: To add a second playlist, touch  then New playlist.

Deleting a playlist

- 1 Touch  then select **Music** from the Entertainment tab.
- 2 Access the folder Playlists and touch the  option icon.
- 3 Touch **Delete** or **Delete all** to delete all of the playlists.

Using the radio

Your LG BL40 has a built-in FM radio tuner so you can listen to your favourite stations on the move.

NOTE: You will need to attach your earphones to listen to the radio. Insert them into the earphones socket.



Multimedia



Searching for stations

You can tune your phone to radio stations by searching for them manually or automatically. They will then be saved to specific channel numbers, so you don't have to keep re-tuning. You can store up to 48 channels on your phone.

Automatic tuning:

- 1 Touch  then select **FM radio** from the Entertainment tab.
- 2 Touch .
- 3 Touch **Autoscan**. The stations found will be allocated to channel numbers in your phone.

NOTE: You can also manually tune to a station by using the wheel displayed next to the radio frequency.

Listening to the radio

- 1 Touch  then select **FM radio** from the Entertainment tab.
- 2 Touch the channel number of the station you would like to listen to.

TIP! To improve radio reception, extend the headset cord, which functions as the radio aerial.

 **WARNING:** If you connect the headset not specifically made for the phone, this may cause interference with radio reception.

Using the FM transmitter to play music

The BL40 allows you with its built-in FM transmitter to listen to your music via any FM tuner in range of the phone, e.g. at home or in your car.

- 1 Touch  then **Tools** from the Utilities tab. Select **FM Transmitter**.
- 2 Select a frequency at which your phone shall transmit an FM signal of your music.
- 3 Touch **Transmit**.

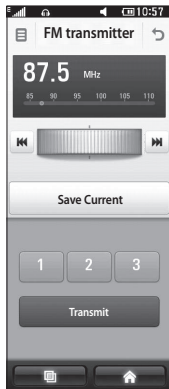

Organiser



Adding an event to your calendar

- 1 From the home screen select  then touch **Organiser** from the Utilities tab.
- 2 Select the date to which you want to add an event.
- 3 Touch  then **New schedule**.
- 4 Touch **Category** then choose between **Appointment**, **Anniversary** or **Birthday**. Check the date and enter the time you want your event to begin.
- 5 For appointments and anniversaries, enter the time and date the event finishes in the lower time and date boxes.
- 6 If you would like to add a subject or note to your event, touch **Subject** and location (for appointments) type in the details.
- 7 Select **Alarm** to set an alert for the event. If you want to repeat the alarm, select **Repeat**.



- 8 Touch  to save the event in the calendar. A coloured square cursor will mark all days that have saved events, and an alarm will sound at the event start time, to help you stay organised.

TIP! You can enter holidays in your calendar. Individually touch each day of the holiday, then touch  and select **Set holiday**. Each day will be marked in red text.

Changing your default calendar view

- 1 From the home screen select  then scroll through **Organiser** in Utilities tab. Select **Settings** in .
- 2 Touch **Default view** and choose Month, Week, Timetable, List or All tasks.

Adding an item to your To Do list

- 1 From the home screen select  then scroll through **Organiser** in Utilities tab.
- 2 Select **New task** in  and touch **Notes**.
- 3 Set the date for the task, add notes, then select its priority level: **High**, **Medium** or **Low**.
- 4 Save the task by selecting .

TIP! You can back up and synchronise your calendar with your computer by using the PC Suite.

Using the date finder



Date finder is a handy tool to help you calculate what the date will be once a certain number of days have passed. For example, 60 days from 10.10.2009 will be 09.12.2009.

This helps you keep track of deadlines.

- 1 From the home screen select  then scroll through **Organiser** in Utilities tab.
- 2 Select **Date finder** from the option menu.
- 3 In the **From** tab set the required date.
- 4 In the **After** tab set the number of days.
- 5 The **Target date** will be shown.



Organiser

Setting your alarm

- 1 From the home screen select  then scroll through **Alarms** in Utilities tab.
- 2 If you want to add a new alarm, touch **New alarm**. If you want to set the alarm to sound again within one hour, touch **Quick alarm**.
- 3 Set the time you would like the alarm to sound.
- 4 Choose whether you want the alarm to repeat and set the repeat type. The icons indicate the weekday you select.
- 5 Select **Sound/ Vibration** to select the type of alarm you want.
- 6 Touch **Alarm bell** then select bell. To listen to sounds, touch the sound, followed by .
- 7 Touch **More** to set other options.
- 8 Touch  to save.

TIP! Touch On icon or set  to start the alarm.

Adding a memo



- 1 From the home screen select  then scroll through **Memo** in Utilities tab.
- 2 Touch **New memo**.
- 3 Touch the screen then the keypad appeared. Type your memo, and then touch .

TIP! You can edit an existing memo. Select the one to be edited, touch **Edit** and type in your changes.

Voice recorder

Use your voice recorder to record voice memos or other audio files.

Recording a sound or voice

- 1 From the home screen select  then scroll to **Voice recorder** in the Utilities tab.
- 2 Touch  to begin recording.
- 3 Touch  to end recording.





- 4 If you touch , it will automatically restart the voice recording after saving the previous one.

Sending the voice recording

- 1 Once you have finished recording, touch **Send**.
- 2 Choose **Message**, **Email** or **Bluetooth**. If you choose **Message** or **Email**, the recorded track will be attached to the message and sent as MMS. If you choose **Bluetooth**, your phone will search for a device to send the voice recording to.

Using your calculator

- 1 From the home screen select , then scroll to **Calculator** in the Utilities tab.
- 2 Touch the number keys to enter numbers.
- 3 For simple calculations, touch the function you require (+, -, x or ÷), followed by =.
- 4 For more complex calculations, touch  and choose from **sin**, **cos**, **tan**, **deg**, **log** etc..

Organiser



Converting a unit

- 1 From the home screen select , then scroll to **Tools** in the Utilities tab.
- 2 Select **Unit converter**.
- 3 Choose whether you want to convert **Currency, Area, Length, Weight, Temperature, Volume** or **Velocity**.
- 4 Then select the unit, and enter the value you would like to convert from.
- 5 The corresponding value for all units will appear on the screen.

Using the stopwatch

- 1 From the home screen select , then scroll to **Tools** and select **Stopwatch** in the Utilities tab.
- 2 Touch **Start** to begin the timing.
- 3 Touch **Lap** if you want to record a lap time.
- 4 Touch **Stop** to end the stopwatch.
- 5 Touch **Resume** to restart the stopwatch from the point you stopped it, or touch **Reset** to start the stopwatch again.

Adding a city to your world clock

- 1 From the home screen select  .
- 2 Scroll to **Tools** and select **World clock** in the Utilities tab.
- 3 Touch the  icon, followed by **Add city**.

PC Suite

You can synchronise your PC with your phone. This will ensure all your important details and dates match, and also act as a back up to help put your mind at ease.

TIP! You will need to install the application PC Suite provided on the CD-ROM or available as a download from <http://update.lgmobile.com>. (From www.lgmobile.com PRODUCTS > Manual & Software > Go to Manual & S/W Download Section)

Installing the LG PC Suite on your computer

- 1 From the home screen, touch  and then click **Connectivity**.
- 2 Select **USB connection** and click **PC Suite**.
- 3 Connect handset and PC via USB cable and wait for a while.

- 4 Installation guide message will be displayed.

Caution! If installation guide message is not displayed in your PC, please check your CD-ROM setting on Windows.

- 5 Insert the supplied CD-ROM or the click the download button to directly download the LG PC Suite program from the internet.
- 6 Click on the LG PC Suite Installer which will appear on your screen.

Connecting your phone and PC

- 1 Select PC Suite mode in Connectivity menu and then connect the USB cable to your phone and your PC.
- 2 LG PC Suite will be automatically activated on your PC.
- 3 Your phone and PC are now connected.

PC Suite

Backing up and restoring your phone's information

- 1 Connect your phone to your PC as outlined above.
- 2 Click on the **Backup** icon, and select **Backup** or **Restore**.
- 3 Choose whether to back up **Contents Data** and/or **Phonebook/Schedule/ToDo/Memo Data**. Select the location you want to back up the information to, or restore it from. Click **OK**.
- 4 Your information will be backed up.

Viewing phone files on your PC

- 1 Connect your phone to your PC as outlined above.
- 2 Click on the Manage Photos, Videos or music icon.
- 3 Images, audio files and videos you have saved on your phone will be displayed on the screen in the LG Phone folder.

TIP! Viewing the contents of your phone on your PC helps you to arrange files you no longer need.

Synchronising your contacts

- 1 Connect the phone to your PC.
- 2 Click on the **Contacts** icon.
- 3 Click **Sync Contacts** button your PC will now import and display all the contacts saved on your phone.
- 4 Click on **Menu** and select **Export**. You can now select where you want to save your contacts to.

Synchronising the messages

- 1 Connect the phone to your PC.
- 2 Click on the Messages icon.
- 3 All your phone messages will be displayed in folders on the screen.
- 4 Use the toolbar at the top of the screen to edit and rearrange messages.

Music Sync

This menu lets you add music to your BL40. Before you start transferring music from your PC to your phone, make sure your computer has the following set-up and accessory is at hand:

- Microsoft Windows XP or Vista
- Windows Media Player 10 or above
- USB data cable
- microSD card (If you wish to use external memory as the music storage.)

WARNING

Do not disconnect your phone during the transfer.

PC Suite

Transferring music using Windows Media Player

- 1 From the home screen select , then scroll through **Connectivity** in the **Settings** tab.
- 2 Select **USB connection mode** and choose **Music sync**.
- 3 Connect your handset and PC using a compatible USB cable.
- 4 When you try to connect the handset to your PC, your handset will read: "Music Sync" followed by Connected.
- 5 The PC will prompt you to launch your preferred music management software.
- 6 Select Window Media Player.
- 7 Go to the Sync Tab, then drag and drop the music you wish to transfer to your handset into the **Sync List** panel.
- 8 Click on the **Start Sync** button. This starts the transfer process.

WARNING

Do not disconnect your phone during the transfer.

DivX Converter

Install the DivX converter, which is supplied on the same CD-ROM as the PC Suite software. DivX will convert media files on your PC to a format that lets you upload them and view them on your phone.

Once installed, select **DivX** from the Program Files on your PC, then **DivX converter** followed by Converter.

Use the arrows in the application to change the conversion format to Mobile. If you right click on the application box and select **Preferences**, you can change the location where the converted files are saved.

Drag and drop the files into the application for initial analysis. Then select **Convert** for the process to begin. When the process is complete a Conversion complete pop up will be displayed.

The web

Vodafone live!

Vodafone live! gives you a fast, full-colour world of games, music, news, sport, entertainment and lots more, straight to your mobile phone.

Wherever you are and whatever you're into.

Accessing the web

- 1 From the home screen select  then scroll through **Vodafone live!** in the Utilities tab.
- 2 To go straight to the browser home page, select **Home**. Alternately, select **Enter address** and type in the URL, followed by **Connect**.

NOTE: You will incur extra cost by connecting to these services and downloading content. Check data charges with your Network Operator.

Adding and accessing bookmarks

For easy and fast access to your favourite websites, you can add bookmarks and save web pages.

- 1 From the home screen select  then scroll through **Vodafone live!** in the Utilities tab.
- 2 Select **Bookmarks**. A list of your Bookmarks will appear on the screen.
- 3 To add a new bookmark, touch **New Bookmark**. Enter a name for the bookmark followed by its URL.
- 4 Touch . Your Bookmark will now appear in the bookmark list.
- 5 To access the bookmark simply touch the bookmark then touch connect. You will be connected to the corresponding URL.

Using the RSS reader

RSS (Really Simple Syndication) is a family of web feed formats used to publish frequently updated content, such as blog entries, news headlines or podcasts. An RSS document, called a feed, web feed, or channel, contains either a summary of content from an associated web site or its full text. RSS makes it possible for people to keep up with their favourite web sites in an automated way that is easier than checking manually.

The user subscribes to a feed by entering its link into the reader or by clicking an RSS icon in a browser that starts the subscription process. The reader checks the user's subscribed feeds regularly for new content and downloads any updates that it finds.

Accessing a saved page

- 1 From the home screen select  then scroll through **Vodafone live!** in the Utilities tab.
- 2 Select **Saved pages**.
- 3 Select the page you want to view and it will open.

Viewing your browser history

- 1 From the home screen select  then scroll through **Vodafone live!** in the Utilities tab. Select **History**.
- 2 The web pages you have accessed recently will be displayed. To access any of these pages, simply select it.

The web

Changing web browser settings

- 1 From the home screen select  then scroll to **Connectivity** in the Settings tab.
- 2 Select **Browser settings**.
- 3 You can edit the **Profiles, Appearance settings, Cache / Cookies, Security, or Reset settings**.
- 4 You can simply set these on or off by touching the switch icon.

Using your phone as a modem

Your BL40 can be used as a modem for your PC, giving you email and internet access even when you don't have any wired connection. You can do this via the USB cable or Bluetooth.

Using the USB cable:

- 1 Ensure you have the LG PC Suite installed on your PC.
- 2 Connect your BL40 and PC using the USB cable and launch the LG PC Suite software.
- 3 Click **Communication** on your PC. Then click **Settings** and select **Modem**.
- 4 Choose **LG Mobile USB Modem** and select **OK**. It will now appear on the screen.
- 5 Click Connect and your PC will connect via your BL40.

Using Bluetooth:

- 1 Ensure Bluetooth is switched **On** and **Visible** for both your PC and BL40.
- 2 Pair your PC and BL40 so that a passcode is required to connect them.
- 3 Use the **Connection wizard** on your LG PC Suite to create an active Bluetooth connection.
- 4 Click **Communication** on your PC. Then click **Setting**.
- 5 Click **Modem**.
- 6 Choose **Standard Modem over Bluetooth link** and click **OK**. It will now appear on the screen.
- 7 Click **Connect** and your PC will connect via your BL40.

Settings

This folder lets you adapt your settings to personalise your BL40.

Changing your screen settings

- 1 From the home screen select  then scroll through **Display settings** in the Settings tab.
- 2 You can choose the option menu from:
 - Wallpaper** - Choose an image for locking, switching the phone on or off, or making or receiving a call.
 - Homescreens** - Widget/ Contact/ Browser/ Shortcut
 - Lock screen** - Choose the clock type on the lock screen.
 - Lock screen gesture** - Choose the gesture by drawing on the lock screen menus.
 - Main menu icon** - Choose the main menu style.
 - Font** - Adjust the font size and style.

Auto brightness - Adjust the screen brightness automatically.

Personalising your profiles

You can quickly change your profile on the home screen. Just touch the status summary icon on the top, then touch the profile tab.

Using the settings menu, you can personalise each profile setting.

- 1 From the home screen select  then scroll through **Profiles** in the Settings tab.
- 2 Choose the profile you want to edit: **Normal**, **Silent**, **Outdoor** or **Flight mode**
- 3 You can then change all sounds and alert options available in the list, including your **Voice/Video ringtone**, **Volume**, **Message alerts** and others.

Changing your phone settings

Enjoy the freedom of adapting the BL40 to your own preferences.

1 From the home screen select  then scroll to **Phone settings** in the Settings tab.

2 Select a menu from the list below:

Date & Time - Adjust your date and time settings or choose to auto update the time when travelling or for daylight saving.

Power save - Choose to switch the factory set power saving settings to **On** or **Off**.

Languages - Change the language on your BL40's display.

Auto lock - Lock the keypad automatically on the home screen.

Security - Adjust your security settings, including PIN codes and handset lock. The default security code is 0000.

Memory info.

Reset settings - Restores all settings to their factory defaults.

Information - View BL40 technical information.

Changing your touch settings

From the home screen select  then scroll to **Touch settings** in the Settings tab.

Touch vibration - Change the type of vibration.

Vibration type - Vibration 1/2/3

Vibration volume - Controls the strength of vibration.

Touch sound - Change the tone when touching the screen.

Sound - Sound 1/2/3

Volume - Controls the volume of tone.

Settings

Changing your connectivity settings

Your connectivity settings have already been set up by your network operator, so you can enjoy your new phone immediately. To change any settings, use this menu:

From the home screen select  then scroll to **Connectivity** in the Settings tab.

Network selection - Your BL40 will connect automatically to your preferred network.

Internet profile - Set the profiles for connecting to the internet.

Access points - Your network operator has already saved this information. You can add new access points using this menu.

Server synchronisation - You can backup or restore contacts to the PC through Synch service.

Home network - You can share contents in your handset by Home network. It can approach the stuff menu - Music, Video, Image and external memory too.

Switch on to start home networking and confirm my device name and check items to sharing.

It can support the following files. Music: mp3, Video: H.264(AVC)/ AAC/ MP4, Image: jpeg.

If you turn on the Home network function in the state of Wi-Fi off, it will be connected automatically after Wi-Fi has been turned on.

When this fail, you can select Home network from the Wi-Fi searching screen. In flight mode the home network mode will be turned off automatically.

GPS type - Choose either **Assisted GPS** or **Stand alone**.

GPS

- The GPS technology uses information from earth-orbiting satellites to find locations.
- A receiver estimates the distance to GPS satellites based on the time it takes for signals to reach them, then uses that information to identify its location.
- This may take from a couple of seconds to several minutes.
- Assisted GPS(A-GPS) on this mobile is used to retrieve location assistance data over a packet data connection with the terrestrial networks.
- The assistance data is only retrieved from the Service server when offered by your network provider and needed.

Note: GPS service has an error tolerance and will not work in buildings or underground.

USB connection - Synchronise your BL40 using the LG PC Suite software to copy files from your phone.

TV out - Choose **PAL** or **NTSC** when connecting your BL40 to a TV.

DivX VOD registration - This menu is used to generate a DivX VOD registration code. Please visit <http://vod.divx.com> to register and for technical support.

Packet data conn. - Set the packet data connection.

Browser settings - Set the values related to the browser.

Streaming settings - Your network operator has already saved this information. You can edit it if you want to make changes.

Java settings - Allows you to set profiles for connections made by Java programs and to view certificates.

Settings

Using memory manager

Your BL40 has three available memories: the phone itself, the USIM card and an external memory card (microSD, which you may need to purchase separately). You can use memory manager to see how much of each memory has been used and how much space is available.

From the home screen select  then scroll through **Phone settings** in the Settings tab. Select **Memory info..**

Handset multimedia memory -

View the memory for multimedia content such as Pictures, Sounds, Video, Flash and Documents.

Handset reserved memory -

View the memory available on your handset for SMS, Contacts, Calendar, Tasks list, Memos, Alarms, Call history, Bookmarks and Miscellaneous items.

USIM memory - View the memory available on your USIM Card.

External memory - View the memory available on your external memory card (which you may need to purchase separately).

Using flight mode

Turn flight mode on by selecting  then **Settings** > **Profiles** and select **Flight mode**.

Flight mode prevents you making calls, connecting to the Internet, sending messages or using Bluetooth.

Sending and receiving files using Bluetooth

Bluetooth is a great way to send and receive files as it does not require any wired connection, is quick and easy. You can also connect to a Bluetooth headset to make and receive calls.

To send a file:

- 1 Open the file you want to send, which will typically be a photo, video or music file.
- 2 Touch  and choose **Send**. Select **Bluetooth**.
- 3 If you have already paired the Bluetooth device, your BL40 will not automatically search for other Bluetooth devices. If not, your BL40 will search for other Bluetooth enabled devices within range.
- 4 Choose the device to which you want to send the file to and touch **Select**.
- 5 Your file will be sent.

TIP! Check the progress bar to make sure your file has been sent.

To receive a file:

- 1 To receive files your Bluetooth must be set to **On**. See **Changing your Bluetooth settings** below for more information.
- 2 A message will prompt you to accept the file from the sender. Touch **Yes** to receive the file.
- 3 You will see where the file has been saved and choose to **View** the file or **Use as wallpaper** (image file only). Files will usually be saved to the appropriate folder in My Files.

Settings

Changing your Bluetooth settings

1 From the home screen select  then scroll through **Bluetooth** in the Settings tab.

2 Touch .

Make changes to:

My device information - Enter a name for your BL40.

My device visibility - Choose to be **Visible**, **Hidden** or **Visible for 1 min**.

Remote USIM mode on -

Activate the remote USIM mode.

Supported services - Select how to use Bluetooth in association with different services.

Delete - Choose to delete the paired device lists.

Delete all - Choose to delete all the paired device lists.

Pairing with another Bluetooth device

By pairing your BL40 with another device, you can set up a passcode protected connection. This makes your pairing more secure.

- 1 Check that your Bluetooth is **On**. You can change your visibility using the **Settings** menu.
- 2 Touch **New device** to search.
- 3 Your BL40 will search for Bluetooth devices. When the search is completed **Refresh** icon will appear on the screen.
- 4 Choose the device you want to pair with and enter a passcode, then touch **OK**.
- 5 Your phone will then connect to the other device, on which you will need to enter the same passcode.
- 6 Your passcode-protected Bluetooth connection is now ready.

Using a Bluetooth headset

- 1 Check that your Bluetooth is **On**.
- 2 Follow the instructions that came with your headset to put it in pairing mode and pair your devices.
- 3 The headset will be automatically switched to Headset profile.
- 4 Touch **Ask always** or **Allow without ask**.

NOTE: Bluetooth Headset sold separately.

Wi-Fi

Wireless Manager allows you to manage Internet connections per Wi-Fi (Wireless LAN) on your device. It allows the phone to connect to local wireless networks or access the Internet wirelessly. Wi-Fi is faster and has a greater range than Bluetooth wireless technology and can be used for fast emailing and Internet browsing.

NOTE: The BL40 supports WEP, WPA-PSK/2 encryption, and not EAP, WPS encryption. If your Wi-Fi service provider or network administrator sets encryption for network security, fill in the key in the pop-up window. If encryption is not set, this pop-up window will not be shown. You can obtain the key from your Wi-Fi service provider or network administrator.

1. How to set up Wi-Fi

- 1 Wi-Fi On
- 2 AP (Access Point) Search
 - Searches which AP it can connect to.
- 3 AP Connect
 - Connects to the desired AP from the AP search list.
 - If the AP is security type WEP or WPA-PSK/2, enter the security key.

2. Wi-Fi network profile support

- 1 Wi-Fi profile support (how to connect to a frequently-used AP or Hidden AP)
 - 1) If the AP does not appear in the search list, you can connect to it by saving it as a profile.
 - 2) Saving the frequently-used AP as a profile makes it easier to

enter the Security key when connecting to an AP with that Security type.

3) If the AP does not support DHCP, you can connect to the AP using a static IP address.

2 Description of each field in the Wi-Fi profile.

1) Network name: SSID (ID)

2) Security type: WEP, WPA-PSK/2 support.

3) Security key: saves the security key.

4) IP/DNS setting: this allows you to set to Automatic or Static depending on whether the AP supports DHCP.

For Static, enter the field value of the IP address and DNS server to use with the static IP address when connecting.

3 How to save the Wi-Fi profile

1) Select Saved networks from the Options menu, then select **New network** and enter values into each field.

2) It is possible to select and save the AP search list by selecting **Wi-Fi On** and then **Refresh** (Searching AP).

3) After connecting to an AP with this Security type, the profile will be saved automatically.

3. How to obtain MAC address

For setting up a connection in some wireless networks with MAC filter you may need to enter the MAC address of your BL40 into the router.

1 Touch Wi-Fi from the settings tab, then open the options menu.

2 Select My MAC Address and it will be displayed.

Phone Software update

LG Mobile Phone Software update from internet

For more information on using this function, please visit the LG Mobile website

**path: <http://www.lgmobile.com>
- select country – Products menu
- Manual & software menu**

This Feature allows you to update the firmware of your phone to the latest version conveniently from the internet without the need to visit any service center.

As the mobile phone firmware update requires the user's full attention for the duration of the update process, please make sure to check all instructions and notes that appear at each step before proceeding. Please note that removing the USB data communication cable or battery during the upgrade may seriously damage you mobile phone.

As the manufacturer takes no responsibility for loss of data during the update process, you are advised to note down any important information in advance for safekeeping.

Accessories

There is a variety of accessories available for your mobile phone, which may be sold separately. You can select these optional items according to your personal communication requirements. Please consult your local dealer for availability. **(The items described below are delivered in the box)**

Charger



Battery



Stereo headset



Data cable and CD-ROM

To connect and synchronise your BL40 and PC. The CD-ROM contains also this User Guide in electronic format.



User Guide



NOTE:

- Always use genuine LG accessories.
- Failure to do this may invalidate your warranty.
- Accessories may vary in different regions.

Network service

The wireless phone described in this guide is approved for use on GSM/W-CDMA networks.

A number of features included in this guide are called Network Services. These are special services that you arrange through your wireless service provider. Before you can take advantage of any of these Network Services, you must subscribe to them through your service provider and obtain instructions for their use from your service provider.

DivX VOD registration

Generate a DivX VOD registration code.

Please visit <http://vod.divx.com/> for registration and technical support.

Technical data

General

Product name: BL40

System: GSM/ W-CDMA

Ambient Temperatures

Max: +55°C (discharging),
+45°C (charging)

Min: -10°C

Declaration of Conformity



Suppliers Details

Name

LG Electronics Inc

Address

LG Electronics Inc. LG Twin Towers 20,
Yeouido-dong, Yeongdeungpo-gu, Seoul, Korea 150-721

Product Details

Product Name

GSM/ W-CDMA Terminal Equipment

Model Name

BL40

Trade Name

LG

CE 0168 !

Applicable Standards Details

R&TTE Directive 1999/5/EC

EN 301 489-01 V1.6.1, EN 301 489-07 V1.3.1, EN 301 489-09 V1.3.1

EN 301 489-17 V1.2.1, EN 301 489-19 V1.2.1, EN 301 489-24 V1.4.1

EN 301 511 V9.0.2

EN 301 908-1 V3.2.1 EN 301 908-2 V3.2.1,

EN 300 328 V1.7.1, EN 301 357-2 V1.3.1

EN 50360:2001/EN62209-1:2006

EN 60950-1 : 2001

Supplementary Information

The conformity to above standards is verified by the following Notified Body(BABT)

BABT, Balfour House, Churchfield Road, Walton-on-Thames, Surrey, KT12 2TD, United Kingdom
Notified Body Identification Number : 0168

Declaration

I hereby declare under our sole responsibility that the product mentioned above to which this declaration relates complies with the above mentioned standards and Directives

European Standard Center
LG Electronics Logistics and Services B.V.
Veluwezoom 15, 1327 AE Almere, The Netherlands
Tel : +31 - 36- 547 - 8940, Fax : +31 - 36 - 547 - 8794
e-mail : jacob @ lge.com

Name

Issued Date

Seung Hyoun, Ji / Director 31.Jul. 2009

Signature of representative

Trouble shooting

This chapter lists some problems you might encounter while using your phone. Some problems require you to call your service provider, but most are easy for you to correct yourself.

Message	Possible causes	Possible Solutions
USIM error	There is no USIM card in the phone or it is inserted incorrectly.	Make sure the USIM card is correctly inserted.
No network connection	Signal weak Outside GSM network area	Move towards a window or into an open area. Check the Network Operator coverage map.
Codes do not match	To change a security code, you will need to confirm the new code by entering it again. The two codes you have entered do not match.	Contact your Service Provider.
Function cannot be set	Not supported by Service Provider, or registration required	Contact your Service Provider.
Calls not available	Dialling error New USIM card inserted Charge limit reached	New network not authorised. Check for new restrictions. Contact Service Provider or reset limit with PIN 2.

Message	Possible causes	Possible Solutions
Phone cannot be switched on	On/Off key not pressed long enough Battery empty Battery contacts dirty	Press the On/Off key down for at least two seconds. Keep charger attached for a longer time. Clean the contacts.
Charging error	Battery totally empty	Charge battery.
	Temperature out of range	Make sure the ambient temperature is right, wait for a while, and then charge again.
	Contact problem	Check the power supply and connection to the phone. Check the battery contacts and clean them if necessary.
	No mains voltage	Plug in to a different socket or check the voltage.
	Charger defective	If the charger does not warm up, replace it.
	Wrong charger Battery defective	Only use original LG accessories. Replace battery.
Phone loses network	Signal too weak	Reconnection to another service provider is automatic.
Number not permitted	The Fixed dial number function is on.	Check settings.

MANUFACTURER'S WARRANTY

Australia & New Zealand

1. WHAT THIS WARRANTY COVERS:

LG offers you a warranty that the enclosed Product and its enclosed accessories will be free from defects in material and workmanship according to the following terms and conditions:

- (1) The warranty for the Product is for ONE (1) year beginning on the date of purchase of the Product.
- (2) The warranty extends only to the original consumer purchaser of the Product ("Customer") and is not assignable or transferable to any subsequent customer.
LG offers a warranty for genuine LG battery packs, extending SIX (6) months from the date of purchase.
- (3) This warranty is only valid to the original purchasing Customer for the duration of the warranty period as long as it is purchased and used in AUSTRALIA or NEW ZEALAND.
- (4) During the warranty period, any defective LG Product or part will be repaired or replaced by LG or its authorised service centre, at LG's option, with new or factory rebuilt replacement items. LG or the authorised service centre will return the Product to the Customer in working condition. No charge for either parts or labour in repair or replacement of the Product will be incurred by the Customer. If parts, boards or equipment are replaced, they shall become the property of LG.
- (5) Upon request from LG, the Customer must provide LG with proof of the date of purchase.
- (6) The Customer will bear the cost of transporting, delivering and handling the Product to and from LG or its authorised service centre.
- (7) The benefits available from this warranty are in addition to all applicable statutory rights.

2. WHAT THIS WARRANTY DOES NOT COVER:

- (1) Defects or damage resulting from use of the Product in other than its normal and customary manner.

- (2) Defects or damage from abnormal use, abnormal conditions, improper storage, exposure to moisture or dampness, unauthorised modifications, unauthorised connections, unauthorised repair, misuse, neglect, abuse, accident, alteration, improper installation, or other acts which are not the fault of LG, including damage caused by shipping, blown fuses, spills of food or liquid.
- (3) Breakage or damage to antennas, unless caused directly by defects in material or workmanship.
- (4) If the Customer does not notify LG of the alleged defect or malfunction of the Product during the applicable warranty period, the Customer shall have no coverage or benefits under this warranty.
- (5) Products which have had the serial number removed or made illegible.
- (6) If the battery short circuits or the seals of the battery are broken or show evidence of tampering, or the battery was used in equipment in a manner other than that which has been specified, the Customer shall have no coverage or benefits under this warranty.
- (7) Damage resulting from use of non-LG approved accessories.
- (8) All plastic surfaces and all other externally exposed parts that are scratched or damaged due to normal use.
- (9) Products operated outside published maximum ratings.
- (10) Products used or obtained in a rental program.
- (11) Consumables (such as fuses).
- (12) Defects or damage resulting from breakage of or tampering with the LCD screen.
- (13) Where applicable, Products that have been subject to an unauthorised removal or deactivation of the network operator lock function.

MANUFACTURER'S WARRANTY

Australia & New Zealand

3. STATEMENT:

Except for those terms that cannot by law be excluded, all terms other than those expressly contained in this warranty statement are excluded. To the extent permitted by law, LG excludes all liability (whether in contract, tort or otherwise) for any consequential, special, incidental or indirect loss or damage including loss of profit, loss or impairment of privacy of conversations, work stoppage or loss or impairment of data arising out of the use or inability to use the Product.

4. HOW TO GET WARRANTY SERVICE:

To obtain information regarding warranty service, please call the following toll free telephone numbers;

AUSTRALIA:

LG Electronics Australia Pty Ltd
2 Wonderland Drive
Eastern Creek NSW 2766
PO Box 212
HORSLEY PARK NSW 2175
Tel: 1800-638-080
Fax: 02-8805-4201

NEW ZEALAND:

LG Electronics Australia Pty Ltd
Unit A, 38 Highbrook Drive
East Tamaki 2013
PO Box 58195 Greenmount
Auckland 2141
Tel: 0800-666-780
Fax: 09-914-2441



LG Electronics Australia Pty Ltd.