



Part No. MMBB0203902

Issue 1.0
Printed in Korea

KG220 User Guide



KG220 User Guide

Some of contents in this manual may differ from your phone depending on the software of the phone or your service provider.



CE 0168



KG220 User Guide - ENGLISH



Disposal of your old appliance

1. When this crossed-out wheeled bin symbol is attached to a product it means the product is covered by the European Directive 2002/96/EC.
2. All electrical and electronic products should be disposed of separately from the municipal waste stream via designated collection facilities appointed by the government or the local authorities.
3. The correct disposal of your old appliance will help prevent potential negative consequences for the environment and human health.
4. For more detailed information about disposal of your old appliance, please contact your city office, waste disposal service or the shop where you purchased the product.

Table of Contents



Introduction	8	Menu Tree	32
Guidelines for safe and efficient use	9	Selecting functions and options	35
KG220 features	13	Call history	36
Parts of the phone	13	Missed calls	36
Display information	16	Received calls	36
Homescreen	18	Dialled calls	36
Getting started	19	All calls	37
Installing the SIM card and the handset battery	19	Delete recent calls	37
Charging the battery	20	Call charges	37
Disconnecting the adapter	21	Call duration	37
Turning your phone on and off	22	Call costs	37
Access codes	22	Settings	38
Barring password	23	GPRS information	38
General functions	24	Call duration	38
Making and answering calls	24	Data volumes	38
Address book	28	Address book	39
In-call menu	29	Contacts	39
Multiparty or conference calls	30	New contact	39
		Caller groups	40

Speed dials	40
Own number	41
My bussiness card	41
Settings	41
Settings	43
Date & Time	43
Set date	43
Date format	43
Set time	43
Time format	43
Phone	43
Display	43
Language	44
Call	44
Call divert	44
Answer mode	45
Send my number	45
Call waiting	45
Minute minder	45

Auto redial	46
Security	46
PIN code request	46
Handset lock	46
Call barring	46
Fixed dial number (FDN)	47
Change codes	48
Network	48
Network Selection	48
Band Selection	48
GPRS	49
Memory status	49
Reset settings	49
Camera	50
Take pictures	50
Take continuously	51
Settings	52
Auto save (On/Off)	52
Clear album	52

Table of Contents



Messaging	53	Orange World	64
New Messages	53	Profiles	66
Write text message	53	Changing the profile	66
Write picture message	54	Customising profiles - Personalise.....	66
Inbox	56	Customising profiles - Rename	67
Drafts	57		
Outbox	57	Media album	68
Listen to voice mail	58	Photos	68
Info messages	58	Images	68
Read	59	Sounds	68
Topics	59	Games & Apps	68
Templates	59	My games & more	68
Text.....	59	Accounts	69
Picture message	60	More pictures	69
Settings	60	More ringtones	69
Text message	60	More games	69
Picture message	61		
Voice mail centre	62	More	70
Info message	63	Calendar	70
Service message	63	Alarm clock	71

Calculator	71
World time	72
Unit converter	72
Voice recorder	73
Q&A	74
Accessories	77
Technical Data	78

Introduction

Congratulations on your purchase of the advanced and compact KG220 mobile phone, designed to operate with the latest digital mobile communication technology.



This user's guide contains important information on the use and operation of this phone. Please read all the information carefully for optimal performance and to prevent any damage to or misuse of the phone. Any changes or modifications not expressly approved in this user's guide could void your warranty for this equipment.

Please read these simple guidelines. Not following these guidelines may be dangerous or illegal. Further detailed information is given in this manual.

Exposure to radio frequency energy

Radio wave exposure and Specific Absorption Rate (SAR) information

This mobile phone model KG220 has been designed to comply with applicable safety requirements for exposure to radio waves. This requirement is based on scientific guidelines that include safety margins designed to assure the safety of all persons, regardless of age and health.

- The radio wave exposure guidelines employ a unit of measurement known as the Specific Absorption Rate, or SAR. Tests for SAR are conducted using standardised methods with the phone transmitting at its highest certified power level in all used frequency bands.
- While there may be differences between the SAR levels of various LG phone models, they are all designed to meet the relevant guidelines for exposure to radio waves.

- The SAR limit recommended by the International Commission on Non-Ionizing Radiation Protection (ICNIRP) is 2W/kg averaged over ten (10) gram of tissue.
- The highest SAR value for this model phone tested by DASY4 for use at the ear is 0.917 W/kg (10g).
- SAR data information for residents in countries/regions that have adopted the SAR limit recommended by the Institute of Electrical and Electronics Engineers (IEEE), which is 1.6 W/kg averaged over one (1) gram of tissue (for example USA, Canada, Australia and Taiwan).

Product care and maintenance

Warning! Only use batteries, chargers and accessories approved for use with this particular phone model. The use of any other types may invalidate any approval or warranty applying to the phone, and may be dangerous.

- Do not disassemble this unit. Take it to a qualified service technician when repair work is required.
- Keep away from electrical appliances such as a TV's, radios or personal computers.



Guidelines for safe and efficient use

- The unit should be kept away from heat sources such as radiators or cookers.
- Never place your phone in a microwave oven as it will cause battery to explode.
- Do not drop.
- Do not subject this unit to mechanical vibration or shock.
- The coating of the phone may be damaged if covered with wrap or vinyl wrapper.
- Do not use harsh chemicals (such as alcohol, benzene, thinners, etc.) or detergents to clean your phone. There is a risk of this causing a fire.
- Do not subject this unit to excessive smoke or dust.
- Do not keep the phone next to credit cards or transport tickets; it can affect the information on the magnetic strips.
- Do not tap the screen with a sharp object as it may damage the phone.
- Do not expose the phone to liquid or moisture.
- Use accessories, such as earphones and headsets,

with caution. Ensure that cables are tucked away safely and do not touch the antenna unnecessarily.

- Please remove the data cable before powering on the handset.

Efficient phone operation

To enjoy optimum performance with minimum power consumption please:

- Do not hold the antenna when the phone is in use. If you hold it, it can affect call quality, it may also cause the phone to operate at a higher power level than needed and shorten talk and standby times.

Electronic devices

All mobile phones may get interference, which could affect performance.

- Do not use your mobile phone near medical equipment without requesting permission. Avoid placing the phone over pacemakers (i.e. in your breast pocket.)
- Some hearing aids might be disturbed by mobile phones.

- Minor interference may affect TVs, radios, PCs, etc.

Road safety

Check the laws and regulations on the use of mobile phones in the areas when you drive.

- Do not use a hand-held phone while driving.
- Give full attention to driving.
- Use a hands-free kit, if available.
- Pull off the road and park before making or answering a call if driving conditions so require.
- RF energy may affect some electronic systems in your motor vehicle such as a car stereo or safety equipment.
- If your vehicle is equipped with an air bag, do not obstruct it with installed or portable wireless equipment. It can cause serious injury due to improper performance.

If you are listening to music whilst out and about, please ensure that the volume is at a reasonable level so that you are aware of your surroundings. This is

particularly imperative when attempting to cross the street.

Avoid damage to your hearing

- Damage to your hearing can occur if you are exposed to loud sound for long periods of time. We therefore recommend that you do not turn on or off the handset close to your ear. We also recommend that music and call volumes are set to a reasonable level.

Blasting area

Do not use the phone where blasting is in progress. Observe restrictions, and follow any regulations or rules.

Potentially explosive atmospheres

- Do not use the phone at a refuelling point. Don't use near fuel or chemicals.
- Do not transport or store flammable gas, liquid, or explosives in the compartment of your vehicle, which contains your mobile phone and accessories.



Guidelines for safe and efficient use

In aircraft

Wireless devices can cause interference in aircraft.

- Turn off your mobile phone before boarding any aircraft.
- Do not use it on the ground without crew permission.

Children

Keep the phone in a safe place out of small children's reach. It includes small parts which if detached may cause a choking hazard.

Emergency calls

Emergency calls may not be available under all mobile networks. Therefore, you should never depend solely on your mobile phone for emergency calls. Check with your local service provider.

Battery information and care

- You do not need to completely discharge the battery before recharging. Unlike other battery systems, there is no memory effect that could compromise the battery's performance.

- Use only LG batteries and chargers. LG chargers are designed to maximize the battery life.
- Do not disassemble or short-circuit the battery pack.
- Keep the metal contacts of the battery pack clean.
- Replace the battery when it no longer provides acceptable performance. The battery pack may be recharged hundreds of times until it needs replacing.
- Recharge the battery if it has not been used for a long time to maximize usability.
- Do not expose the battery charger to direct sunlight or use it in high humidity, such as the bathroom.
- Do not leave the battery in hot or cold places, this may deteriorate the battery performance.

Parts of the phone

Front view



1. Headset jack

- Connect a headset here.

2. Up/down side keys

- Controls the volume of keypad tone in standby mode with the clamshell open.
- Controls the earpiece volume during a phone call.

3. Camera lens

- ⚠ **Note** Dirt on the camera lens could affect the image quality.



Rear view

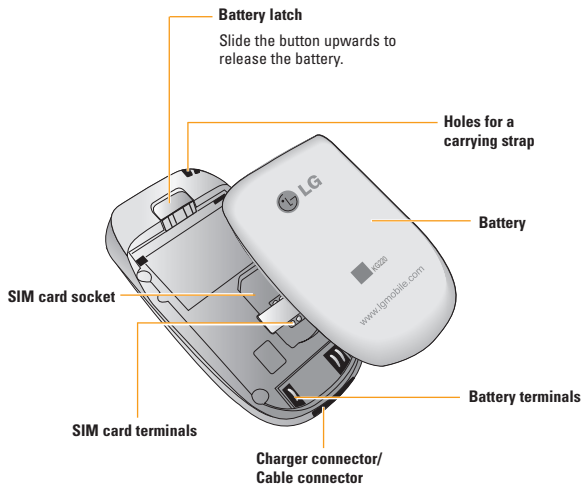

Open view

**1. Earpiece**

2, 10. Left soft key/ Right soft key: Performs the function indicated by the text on the screen immediately above it.

3. Orange World key: A shortcut key to access to Orange World WAP.

4. Send key: Dials a phone number and answers incoming calls. You can also quickly access the latest incoming, outgoing and missed calls by pressing the key in standby mode.

5. Alphanumeric keys: Enter numbers, letters and some special characters.

6. Microphone: Can be muted during a call for privacy.



7. Main screen: Displays phone status icons, menu items, Web information, pictures and more in full colour.

8. Navigation keys: Use to scroll through menus and move the cursor.

9. Confirm key: Selects menu options and confirms actions.











KG220 features











- 11. Camera key:** Press this key to use the camera feature. Directly goes to the camera menu.
- 12. End/Power key:** Used to end a call or reject a call and also to go back to standby mode. Hold this key down to turn the phone on/off.
- 13. Clear key:** Deletes a character by each press. Hold the key down to clear all input. Also use this key to go back to the previous screen.
- 14. Special function keys:**
 -  : A long press of this key activates/deactivates the manner mode.
 -  : A long press of this key enters the international call character "+".
 -  : While keying in a phone number, a long press of this key enters a pause.

Display information

The table below describes various display indicators or icons that appear on the phone's display screen.

On-Screen Icons

Icon	Description
	Indicates the strength of the network signal.
	Indicates a call is in progress.
	Indicates that you are roaming on another network.
	Indicates that GPRS service is available.
	Indicates the alarm has been set and is on.
	Indicates the status of the battery charge.
	Indicates the receipt of a text/picture message.
	Indicates the receipt of a voice message.

Icon	Description
	Indicates that the vibration ringer has been set.
	Indicates the Loud profile is activated.
	Indicates the Silent profile is activated.
	Indicates the Headset profile is activated.
	You can divert a call.
	Indicates the Normal profile is activated.
	Indicates that you can use the push message service.
	Indicates that the phone is accessing the WAP.
	Indicates that you are using GPRS.
	Indicates that you entered the security page.

Homescreen

Orange has added the Home screen to your phone so that you can quickly link to the features you use the most as well as see at a glance any missed calls or new messages.



Quick access

The Home screen lets you launch key features of your phone and great services from Orange in as little as two key presses. Whether you want to send a text message, start exploring Orange World, you can now do it faster than ever.

All the options

Each time you select one of the icons in the left of your screen, you're presented with a list of options that give you even more choice. So, for example, when you want to browse Orange World, you can choose to go direct to Info, Fun, Tools or Your Page.

Installing the SIM card and the handset battery

Make sure the power is off before you remove the battery.

1. Remove the battery.

Slide the battery release latch upwards and lift out the top of the battery.



Note Removing the battery from the phone when the power is on may cause the phone to malfunction.

2. Install the SIM card

Insert the SIM card into the holder. Slide the SIM card into the SIM card holder. Make sure that the SIM card is inserted properly and that the gold contact area on the card is facing downwards. To remove the SIM card, press down lightly and pull it in the reverse direction.



To insert the SIM card



To remove the SIM card

Caution The metal contact of the SIM card can be easily damaged by scratches. Pay special attention to the SIM card while handling. Follow the instructions supplied with the SIM card.



3. Install the battery.

Insert the bottom of the battery first into the bottom edge of the battery compartment. Push down the top of the battery until it snaps into space.

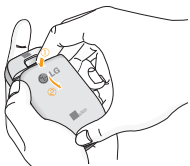

Charging the battery

To connect the mains adapter to the phone, you must have installed the battery.



1. With the arrow facing you as shown in the diagram push the plug on the battery adapter into the socket on the bottom of the phone until it clicks into place.
2. Connect the other end of the mains adapter to the mains socket. Only use the charger included in the box.
3. The moving bars of battery icon will stop after charging is complete.

- ⚠ **Caution**
 - Do not force the connector as this may damage the phone and/or the travel adapter.
 - If you use the battery pack charger out of your own country, use an attachment plug adapter for the proper configuration.
 - Do not remove your battery or the SIM card while charging.
- ⚠ **Warning**
 - Unplug the power cord and charger during lightning storms to avoid electric shock or fire.
 - Make sure that no sharp-edged items such as animal teeth or nails come into contact with the battery. There is a risk of this causing a fire.
 - Do not place or answer calls while charging the phone as it may short-circuit the phone and/or cause electric shock or fire.

Disconnecting the adapter

1. When charging is finished, the moving bars of the battery icon stop and 'Full' is displayed on the screen.
2. Unplug the adapter from the power outlet. Disconnect the adapter from the phone by pressing the grey tabs on both sides of the connector and pull the connector out.



- ⚠ **Note**
 - Ensure the battery is fully charged before using the phone. for the first time.
 - Do not remove the battery or SIM card while charging.
 - In the case the battery is not properly charged, please turn the phone off and on using the power key. Then detach and reattach the battery, and recharge the phone.



Turning your phone on and off

Turning your phone ON

1. Install a battery to the handset and connect the phone to an external power source such as the travel adapter, cigarette lighter adapter or hands-free car kit. Or install a charged battery pack to the handset.
2. Press and hold  for a few seconds until the LCD screen is turned on.
3. Depending on the status of the **PIN code request** setting you may need to enter your PIN code.

Turning your phone OFF

1. Press and hold  for a few seconds until the LCD screen is turned off.

Access codes

You can use the access codes described in this section to avoid unauthorised use of your phone. The access codes (except PUK and PUK2 codes) can be changed by using the **Change codes** feature [Menu 3-4-5]. See page 48.

PIN code (4 to 8 digits)

The PIN (Personal Identification Number) code protects your SIM card against unauthorised use. The PIN code is usually supplied with the SIM card. When the **PIN code request** is set to **Enable**, your phone will request the PIN code every time the phone is switched on. When the **PIN code request** is set to **Disable**, your phone connects to the network directly without the PIN code.

PIN2 code (4 to 8 digits)

The PIN2 code, supplied with some SIM cards, is required to access functions such as **Advice of Call Charge** and **Fixed dial number**. These functions are only available if supported by your SIM card. Check with your network operator for further information.



PUK code (4 to 8 digits)

The PUK (PIN Unblocking Key) code is required to unlock a PIN blocked phone. The PUK code may be supplied with the SIM card. If not, contact your network operator for the code. If you lose the code, please contact your network operator.

PUK2 code (4 to 8 digits)

The PUK2 code, supplied with some SIM cards, is required to change a blocked PIN2 code. If you lose the code, please contact your network operator.

Security code (4 to 8 digits)

The security code protects the unauthorised use of your phone. The default security code is set to '0000' and the security code is required to delete all phone entries and to activate the **Reset settings** menu. Also, the security code is required to enable or disable the phone lock function to prevent unauthorised use of the phone. The security code default setting can be modified from the **Security settings** menu.



Barring password

The barring password is required when you use the **Call barring** [Menu 3-4-3] function. You can obtain the password from your network operator when you subscribe to this function. See page 46 for further details.





Making and answering calls



Making a call

1. Make sure your phone is switched on.
2. Enter a phone number, including the area code.
 - ▶ Press and hold the clear key () to erase the entire number.
3. Press the send key () to call the number.
4. To end the call, press the end key () or the right soft key.

Making a call from the call history list

1. In standby mode, press the send key (), and the latest incoming, outgoing and missed phone numbers will be displayed.
2. Select the desired number by using the up/down navigation keys.
3. Press  to call the number.

Making an international call

1. Press and hold the  key for the international prefix. The '+' character automatically selects the international access code.
2. Enter the country code, area code, and the phone number.
3. Press  to call the number.

Ending a call

When you have finished your call, press the end () key.

Making a call from the address book

You can save the names and phone numbers dialed regularly in the SIM card and/or phone memory. You can dial a number by simply looking up the desired name in the address book and pressing the () key.

Adjusting the volume

If you want to adjust the earpiece volume during a call, use the side keys (). Press the up side key to increase and down side key to decrease the volume.

Note In standby mode with the phone open, pressing the side keys adjusts the key tone volume.

Answering a call

When you receive a call, the phone rings and the flashing phone icon appears on the screen. If the caller can be identified, the caller's phone number (or name/photo if saved in the phonebook) is displayed.

1. To answer an incoming call, open the phone. (When **Flip open** has been set as the answer mode. See page 45 [Menu 3-3-2].)

Note If **Press any key** has been set as the answer mode (see page 45), any key press will answer a call except for the  or the right soft key.

▶ To reject an incoming call, press and hold one of the side keys on the left side of the phone without opening the phone.

▶ You can answer a call while using the address book or other menu features.

2. To end the call, close the phone or press the  key.

Manner mode (Quick)

You can activate the manner mode by pressing and holding down the  key after opening the phone.

Signal strength

You can check the strength of your signal by the signal indicator () on the LCD screen of your phone. Signal strength can vary, particularly inside buildings. Moving near to a window may improve reception.

Entering text

You can enter alphanumeric characters by using the phone's keypad. For example, storing names in the phonebook, writing a message, creating a personal greeting.

The following text input methods are available in the phone.



General functions

T9 mode

This mode lets you enter words with only one keystroke per letter. Each key on the keypad has more than one letter. The T9 mode automatically compares your keystrokes with an internal dictionary to determine the correct word, thus requiring far fewer keystrokes than the traditional ABC mode. This is sometimes known as predictive text.

ABC mode

This mode lets you enter letters by pressing the key labelled with the required letter once, twice, three or four times until the letter is displayed.

123 mode (Number mode)

Type numbers using one keystroke per number. To change to 123 mode in a text entry field, press the  key until 123 mode is displayed.

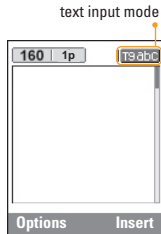

Changing the text input mode

1. When you are in a field that allows characters to be entered, you will notice the text input mode indicator in the top right corner of the LCD screen.
2. Change the text input mode by pressing . You can check the current text input mode in the top right corner of the LCD screen.



► Using the T9 mode

The T9 predictive text input mode lets you enter words easily with a minimum number of key presses. As you press each key, the phone begins to display the characters that it thinks you are typing based on the built-in dictionary. You can also add new words in the dictionary. As new words are added, the word changes to reflect the most likely candidate from the dictionary.

1. When you are in the T9 predictive text input mode, start entering a word by pressing keys  to . Press one key per letter.

- The word changes as letters are typed. Ignore what's on the screen until the word is typed completely.
- If the word is still incorrect after typing completely, press the down navigation key once or more to cycle through the other word options.



Example:

Press     to type **Good**

Press     [Down navigation key] to type **Home**

- If the desired word is missing from the word choice list, add it using the ABC mode.
- You can select the language of the T9 mode. Press the left soft key [Option], then select **T9 languages**. Select the desired language of T9 mode. You can also turn off the T9 mode by selecting **T9 off**. The default setting on the phone is T9 enabled mode.

2. Enter the whole word before editing or deleting any keystrokes.

3. Complete each word with a space by pressing the  key. To delete letters, press .



Note To exit from the text input mode without saving your input, press . The phone goes back to standby mode.

► Using the ABC mode

Use the  to  keys to enter your text.

1. Press the key labelled with the required letter:











- Once for the first letter
- Twice for the second letter
- And so on

2. To insert a space, press the  key once. To delete letters, press the  key. Press and hold down the  key to clear the whole display.



General functions

- Note** Refer to the table below for more information on the characters available using the alphanumeric keys.

Key	Characters in the order display	
	Upper Case	Lower Case
 123	., / ? ! - : ' " 1	., / ? ! - : ' " 1
 234	A B C 2	a b c 2
 345	D E F 3	d e f 3
 456	G H I 4	g h i 4
 567	J K L 5	j k l 5
 678	M N O 6	m n o 6
 789	P Q R S 7	p q r s 7
 890	T U V 8	t u v 8
 90#	W X Y Z 9	w x y z 9
 0*	Space 0	Space 0

► Using the 123 (Number) mode

The 123 mode enables you to enter numbers in a text message (a telephone number, for example).

Press the keys corresponding to the required digits before manually switching back to the appropriate text entry mode.

Address book

You can store phone numbers and their corresponding names in the memory of your SIM card.

In addition, you can store up to 500 numbers and names in the phone memory.

The SIM card and phone are both used in the same way in the **Address book** menu.

In-call menu

Your phone provides a number of control functions that you can use during a call. To access these functions during a call, press the left soft key [Options].

During a call

The menu displayed on the handset screen during a call is different to the default main menu displayed when in standby mode, and the options are described below.

Making a second call

You can get a number you wish to dial from the phonebook to make a second call. Press the right soft key then select **Search**. To save the dialled number into the phonebook during a call, press the right soft key then select **Add new**.

Switching between two calls

To switch between two calls, press the left soft key then select **Swap** or by pressing  key.



Answering an incoming call

To answer an incoming call when the handset is ringing, simply press the  key. The handset is also able to warn you of an incoming call while you are already on a call. A tone sounds in the earpiece, and the display will show that a second call is waiting.

This feature, known as **Call waiting**, is only available if your network supports it. For details of how to activate and deactivate it see **Call waiting** [Menu 3-3-4] on page 45.

If **Call waiting** is activated, you can put the first call on hold and answer the second, by pressing  or by selecting the left soft key[Answer].

Rejecting an incoming call

You can reject an incoming call without answering by simply pressing the  key. During a call, you can reject an incoming call by pressing the right soft key [End] key or by pressing the .



General functions

Muting the microphone

You can mute the microphone during a call by pressing the [Menu] key then selecting **Mute on**. The handset can be unmuted by selecting **Mute off**. When the handset is muted, the caller cannot hear you, but you can still hear them.

Switching DTMF tones on during a call

To turn DTMF tones on during a call, press the left soft key, and then select **DTMF on**. DTMF tones can be turned off the same way. DTMF tones allow your phone to make use of an automated switchboard.

Multiparty or conference calls

The multiparty or conference service provides you with the ability to have a simultaneous conversation with more than one caller, if your network operator supports this feature. A multiparty call can only be set up when you have one active call and one call on hold, both calls having been answered. Once a multiparty call is set up, calls can be added, disconnected or separated (that is, removed from the multiparty call but still connected to you) by the

person who set up the multiparty call. These options are all available from the In-Call menu. The maximum callers in a multiparty call are five. Once started, you are in control of the multiparty call, and only you can add callers to the multiparty call.

Making a second call

You can make a second call while currently on a call. Enter the second number and press the  key. When the second call is connected, the first call is automatically placed on hold. You can swap between calls by pressing the left soft key then selecting **Swap**.

Setting up a conference call

Place one call on hold and while the active call is on, press the left soft key and then select the **Conference/Join all**.

Putting a conference call on hold

Press the left soft key, then select the **Conference/Hold all**.

Activate the conference call on hold

Press the left soft key, then select the **Conference/Join all**.

Adding calls to the conference call

To add a call to an existing conference call, press the left soft key, then select the **Conference/Join all**.

Displaying callers in a conference call

To scroll through the numbers of the callers who make up a conference call on the handset screen, use the up/down navigation keys.

Taking a private call during a conference call

To have a private call with one caller from a conference call, display the number of the caller you wish to talk to on the screen, then press the left soft key. Select the **Conference/Private** to put all the other callers on hold.

Ending a conference call

The currently displayed caller from a conference call can be disconnected by pressing the  key. To end a conference call, press the left soft key, then select the **Conference/End multiparty**. After pressing the left soft key, selecting **Conference/End all** will end all the active and on-hold calls.

Menu Tree

The following illustration shows the available menu structure and indicates the:

- ▶ Number assigned to each menu option.
- ▶ Page where you can find the feature description.

You can go to the desired menu using the left soft key [Menu], navigation keys and the [OK] key. And you can also take a shortcut by pressing the corresponding number key of desired menu after pressing the left soft key [Menu].



1. Call history (see page 36)

- 1 Missed calls
- 2 Received calls
- 3 Dialed calls
- 4 All calls
- 5 Delete recent calls
- 6 Call charges
- 7 GPRS information



2. Address book (see page 39)

- 1 Contacts
- 2 New contact
- 3 Caller groups
- 4 Speed dials
5. Own number
6. My business card
- 7 Settings



3. Settings (see page 43)

- 1 Date & Time
- 2 Phone
- 3 Call
- 4 Security
- 5 Network
- 6 GPRS
- 7 Memory status
- 8 Reset settings

**4. Camera (see page 50)**

- 1 Take pictures
- 2 Take continuously
- 3 Settings

**5. Messaging (see page 53)**

- 1 New messages
- 2 Inbox
- 3 Drafts
- 4 Outbox
- 5 Listen to voice mail
- 6 Info messages
- 7 Templates
- 8 Settings

**6. Orange World (see page 64)**

- 1 Orange World
- 2.Info
- 3.Fun
- 4.Tools
- 5.Yours page
- 6.Favourites
- 7.Go to URL
- 8.Settings
- 9.SIM service

**7. Profiles (see page 66)**

- 1 Normal
- 2 Vibrate only
- 3 Silent
- 4 Loud
- 5 Headset



8. Media album (see page 68)



- 1 Photos
- 2 Images
- 3 Sounds
- 4 Games & Apps
- 5 More pictures
- 6 More ringtones
- 7 More games



9. More (see page 70)

- 1 Calendar
- 2 Alarm clock
- 3 Calculator
- 4 World time
- 5 Unit converter
- 6 Voice recorder

Selecting functions and options

Your phone offers a set of functions that allow you to customise the phone. These functions are arranged in menus and sub-menus, accessed via the two soft keys marked [] and []. Each menu and sub-menu lets you view and alter the settings of a particular function

The roles of the soft keys vary according to the current context or the label on the bottom line of the screen just above each key indicates its current role.

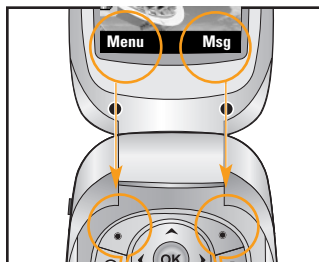

Press the left soft key to access the available menu.

Press the right soft key to access the shortcut menus.



You can check the record of missed, received, and dialed calls only if the network supports Calling Line Identification (CLI) within the service area.

The number and name (if available) are displayed together with the date and time at which the call was made. You can also view call times and costs.

Press the Menu key () and select **Call register** using navigation keys.

Missed calls

Menu 1-1

This option lets you view the last 20 unanswered calls. After selecting a phone number, you can make a call to the number by pressing the send key. After pressing the left soft key [Options], you can also:

- View the number if available and call it or save it in the address book.
- Enter a new name for the number and save in the address book.
- Send a message to this number.
- Delete the call from the list.

Received calls

Menu 1-2

This option lets you view the last 10 incoming calls. After selecting a phone number, you can make a call to the number by pressing the send key. After pressing the left soft key [Options], you can also:

- View the number if available and call it or save it in the address book.
- Enter a new name for the number and save in the address book.
- Send a message to this number.
- Delete the call from the list.

Dialed calls

Menu 1-3

This option lets you view the last 20 outgoing calls (called or attempted). After selecting a phone number, you can make a call to the number by pressing the send key. Using the [Option] key, you can also:

- View the number if available and call it or save it in the address book.

- Enter a new name for the number and save in the address book.
- Send a message to this number.
- Delete the call from the list.

📌 **Note** You can delete all the call records from the list using the **Delete recent calls** menu [Menu 1-5].

All calls Menu 1-4

This option lets you view all lists of outgoing or incoming calls.

Delete recent calls Menu 1-5

Use this to delete the missed call list, received call list, or dialled call list. You can also delete all call lists at one time selecting **All calls**.

Call charges Menu 1-6

Call duration Menu 1-6-1

Use this to view the duration of your incoming and outgoing calls. You can check each call duration at the bottom of screen while scrolling using the up/down

navigation keys. You can reset the call timer by selecting **Reset all**.

- ▶ **Last call:** Length of the last call.
- ▶ **All calls:** Total length of all calls made or received calls since the timer was last reset.
- ▶ **Received calls:** Length of the incoming calls.
- ▶ **Dialled calls:** Length of the outgoing calls.
- ▶ **Reset all:** You can delete all records of call timer.

📌 **Notice** The actual time invoiced for calls by your service provider may vary, depending on network features, rounding-off for billing, etc.

Call costs Menu 1-6-2

This network service allows you to check the last call cost and the total call cost. The call cost is displayed on the bottom of the LCD screen. To reset the call cost, select **Reset all**. You will be requested to enter the PIN2 code.

📌 **Note** The actual cost invoiced for calls by your service provider may vary, depending on network features, rounding-off for billing, taxes, etc.



Call history

Settings

Menu 1-6-3

- ▶ **Set tariff:** You can set the currency type and the unit price. Contact your service providers to obtain charging unit prices.

To select the **Currency** or **1 Unit** in this menu, you need the PIN2 code.

- ⓘ **Note** When all units have been used, no calls can be made except emergency calls. Depending on the SIM card, you need the PIN2 code to set a call cost limit.

- ▶ **Set credit:** This network service allows you to limit the cost of your calls by selected charging units. If you select **Read**, the number of remaining unit is shown. If you select **Change**, you can change your charge limit.
- ▶ **Auto display:** This network service allows you to see automatically the cost of your last call. If you select **On** in **Auto display** menu, you can see the cost of the last call when the call is released.

GPRS information

Menu 1-7

You can check the amount of data transferred over the network through the GPRS information option. In addition, you can also view how much time you are online. (GPRS stands for General Packet Radio Service.)

Call duration

Menu 1-7-1

You can check the duration of **Last call** and **All calls**. You can also reset the call timers by selecting **Reset all**.

Data volumes

Menu 1-7-2

You can check the **Sent**, **Received** or **All** data volumes. You can also reset the counter by selecting **Reset all**.

You can save phone numbers and their corresponding names in the memory of your SIM card.

- Press the left soft key [Menu] in standby mode, then select **Address book**.

Contacts

Menu 2-1

1. Select **Contacts**. You are asked to enter a name.
2. Enter the start of the name that you wish to find and press left soft key [Search].

- **Note** You can also scroll through the address book from the beginning, by pressing the left soft key [List] directly.

3. After finding the desired name, you can make a call to the number by pressing the [send] key. Or press the left key [Options] to use the following options.

- ▶ **Edit:** Edits the name, number, and the listing group.
- ▶ **Write message:** Use this to write messages.
- ▶ **Copy:** Use this to copy the address book entry from SIM to the phone memory or vice versa.
- ▶ **Main number:** You can select one of the mobile,

home or office numbers that you call most often. Once that has been set, that number will be displayed as the main number.

- ▶ **Delete:** Deletes the entry.

New contact

Menu 2-2

You can add an entry using this function.

There are 2 memories: Phone memory and SIM memory. The phone memory capacity is 500 entries. You can enter up to 20 characters in each name in the phone memory. The SIM card memory capacity depends on the SIM card.

1. Scroll to highlight **New contact**, and press [Select].
2. You can add new phonebook entries to SIM memory or the phone memory. To select the memory, go to **Default memory** [Menu 2-7-1].

▶ Adding new entries into SIM memory

You can enter a name and number, and select the required group. (Depends on the SIM)

▶ Adding new entries into the phone memory



Address book

You can enter a name and number, and select the required group.

Caller groups

Menu 2-3

You can classify the address book entries with 7 groups. Use this feature to assign a ring tone and/or a graphic icon to each group. This enables you to identify callers from each group.

1. Select **Caller groups**. Every group list will be displayed: **Family**, **Friend**, **Colleagues**, **VIP**, **Group1**, **Group2**, and **Others**.
2. Select the group name that you want to manage by pressing the left soft key [Select]. The following submenus will be displayed.
 - ▶ **Member list**: Displays the member list in the group.
 - ▶ **Group ring tone**: Use this to select the ring tone to be used when you receive a voice phone call from a person in the group.

- ▶ **Group icon**: Use this to select the graphic icon to be displayed when you receive a call from a person in the group.
- ▶ **Add member**: Add a member to the group.
- ▶ **Remove member**: Delete a member from the group.
- ▶ **Rename**: Assigns a new name to the group.

Speed dials

Menu 2-4

Assign contacts to any of the keys 2 to 9. You can then call that contact by pressing the corresponding number key.

1. Scroll to **Speed dial**, then press [Select].
2. To add a number to **Speed dials**, press the left soft key [Select]. Search the name through the address book.
3. You can change or delete a speed dial number, make a call or send a message by pressing the left soft key [Options].

Own number (SIM dependent) Menu 2-5

You can check and save your own number in the SIM card.

My bussiness card Menu 2-6

This option helps you to make your own name card. Key in the name, mobile phone number, home number, office number, Fax number, and E-mail address.

Settings Menu 2-7

Default memory

You can select the memory for the Address book feature between the SIM and the phone. If you select **Variable**, when adding entry, the phone will ask where to save the number.

View options

Scroll to highlight **View options**. Then press  [Select].

- **Name only:** Set the address book list by displaying the name only.

- **With pictures:** Set the address book list with the information of character and picture.
- **Name & number:** Set the address book list by displaying the name and the number.

Search by

Scroll to highlight **Search by**, then press  [Select].

- **Variable:** The phone will ask how to search.
- **Name or Number:** The phone will search an entry by Name or Number.

Copy all/Move all

You can copy/move entries from the SIM card memory to the phone memory and vice versa.

- ▶ **SIM to Phone:** Use this to copy/move the entries from the SIM Card to Phone memory.
- ▶ **Phone to SIM:** Use this to copy/move the entries from the Phone memory to the SIM Card.



Introduction

The following options are available.

- **Copy all:** The original dial numbers are kept.
- **Move all:** The original dial numbers will be erased.

Memory in use

You can check the current memory status of the SIM card and phone memory.

Clear contacts

You can delete all entries in the SIM or phone memory. This function requires the security code. Press  to return to standby mode.

Service dial number (SIM dependent)

Use this to view the list of Service Dialling Numbers (SDN) assigned by your network operator. Such numbers include the customer services, directory enquiries and voice mail numbers.

1. Select the Service dial number option.
2. The names of the available services will be shown.

3. Use the up/down navigation keys to select a service. Press  .

Press the Menu key () and select **Settings** using navigation keys.

Date & Time Menu 3-1

This option lets you change the current time and date displayed.

The following options are available.

Set date Menu 3-1-1

Use this to enter the day, month and year. You can change the date format via the **Date format** menu option.

Date format Menu 3-1-2

DD/MM/YYYY (day/month/year)

MM/DD/YYYY (month/day/year)

YYYY/MM/DD (year/month/day)

Set time Menu 3-1-3

Use this to enter the current time. You can choose the time format via the **Time format** menu option.

Time format Menu 3-1-4

24-hour

12-hour

Phone Menu 3-2

Many features of your phone can be customised to suit your preferences. All of these features are accessed via the **Phone settings** menu.

Display Menu 3-2-1

- ▶ **Wallpaper:** Select the wallpaper which will be displayed on the LCD screen in standby mode.
- ▶ **Menu colour:** Your Phone provides you with 4 menu colour themes. Set the menu colour by scrolling and pressing the Select key.
- ▶ **Standby text:** If you select **On**, you can edit the text which will be displayed in standby mode.



Settings

- ▶ **Backlight:** Use this to select whether or not the phone uses the backlight. A small increase in standby/talk time can be achieved by turning the backlight off.
- ▶ **Information window:** You can preview the current status of the selected menu before opening the menu. The status is shown at the bottom of the screen.

Language

Menu 3-2-2

You can select the display language. When the language option is set to **Automatic**, the language is automatically selected according to the language of the SIM card used. English will be set if the language on the SIM card is not supported by the phone.

Call

Menu 3-3

To change the settings for call diverting.

Call divert

Menu 3-3-1

When this network service is activated, you can direct your incoming calls to another number, for example, to your voice mailbox number. For details, contact your network operator. Select one of the divert options, for example, select **If busy** to divert voice calls when your number is busy or when you reject incoming calls.

The following options are available.

All voice calls: Diverts all voice calls unconditionally.

If busy: Diverts voice calls when the phone is in use.

If no reply: Diverts voice calls which you do not answer.

If out of reach: Diverts voice calls when the phone is switched off or out of coverage.

All data calls: Diverts to a number with a PC connection unconditionally.

All fax calls: Diverts to a number with a fax connection unconditionally.

Each option has the following menu:

▶ **Activate:** Activates the corresponding service.

- **To voice mail centre:** Forwards to message centre.
- **To other number:** Input the number for call diverting.
- **To favourite number:** You can check back to last five diverted numbers.

▶ **Cancel:** Cancels the selected call divert.



▶ **View status:** You can check the status of the service.

Cancel all: Cancels all call divert settings.

Answer mode Menu 3-3-2

Select the desired mode to answer a call.

▶ **Flip open:** When the phone rings, you can answer a call simply by opening the flip.

▶ **Press any key:** When the phone rings, you can answer a call by pressing any key except the  key and the right soft key ().

▶ **Send key only:** You can answer a call only by pressing the send key.

Send my number Menu 3-3-3

This network service lets you decide whether your phone number is displayed (On) or hidden (Off) from the person you are calling. Select **Set by network** to reset the phone to the setting that you have agreed upon with your service provider.

Call waiting (Network Service) Menu 3-3-4

The network will notify you of a new incoming call while you have a call in progress. Select **Activate** to request the network to activate call waiting, **Cancel** to request the network to deactivate call waiting, or **View status**, to check if the function is active or not.

Minute minder Menu 3-3-5

When set to **On**, the phone will beep every minute during a call to keep you informed of the length of the call.



Settings

Auto redial

Menu 3-3-6

Select **On**, and your phone will make a maximum of five attempts to connect the call after an unsuccessful call attempt.

Security

Menu 3-4

Various passwords are used to protect certain features of your phone. Refer to page 23 for the various passwords.

PIN code request

Menu 3-4-1

When the **PIN code request** feature is enabled, you must enter your PIN each time you switch the phone on. Consequently, any person who does not have your PIN cannot use your phone without your approval.

- **Note** Before disabling the PIN code request feature, you must enter your PIN.

The following options are available:

- **On:** You must enter the PIN each time the phone is switched on.

- **Off:** The phone connects directly to the network when you switch it on.

Handset lock

Menu 3-4-2

When the **Handset lock** feature is enabled, the phone is locked and you must enter the phone password each time the phone is switched on. The password is factory set to **0000**. To change the phone password, refer to the **Change codes – Security code** menu option [Menu 3-4-5]. Once the correct password has been entered, you can use the phone until you switch it off.

Call barring

Menu 3-4-3

Call barring lets you restrict the making and receiving of calls with your phone. For this function, you need the barring password, which you can obtain from your service provider.

The following options are available:

- ▶ **All outgoing:** No call can be made.
- ▶ **International:** International calls cannot be made.

- 
- ▶ **International when roaming:** When abroad, calls can be made only to numbers within the current country and to your home country, the country where your home network provider is located.
 - ▶ **All incoming:** No call can be received.
 - ▶ **Incoming when abroad:** Calls cannot be received when you are using your phone outside your home service area.
 - ▶ **Cancel all:** All call barring settings are deactivated; calls can be made and received normally.
 - ▶ **Change password:** Use this to set and change the call barring password obtained from your service provider using this option. You must enter the current password before you can specify a new one. Once you have entered a new password, you are asked to confirm it by entering it again.
 - ⓘ **Note** To use **Call barring**, you must input the network password. When calls are barred, calls may be possible to certain emergency numbers on some networks.

Fixed dial number (FDN) (SIM dependent)

Menu 3-4-4

Use this to restrict your outgoing calls to selected phone numbers, if this function is supported by your SIM card. The PIN2 code is required.

The following options are available:

- ▶ **Activate:** Use this to only call phone numbers saved in the phonebook. You must enter your PIN2 code.
- ▶ **Cancel:** Allows you to call any number.
- ▶ **Number list:** Use this to view the numbers saved as fixed dial numbers.
- ⓘ **Note** Not all SIM cards have a PIN2. If your SIM card does not, this menu option is not displayed.



Settings

Change codes

Menu 3-4-5

The **Change codes** feature lets you change your current password to a new one. You must enter the current password before you can specify a new one.

Use this to change the access codes: **PIN1 code**, **PIN2 code**, **Security code**.

📌 **Note** PIN: Personal Identification Number.

Network

Menu 3-5

The **Network settings** feature enables you to indicate whether the network used when roaming(outside your home area) is selected automatically, manually or preferably.

📌 **Note** You can select a network other than your home network only if it has a valid roaming agreement with your home network.

Network selection

Menu 3-5-1

▶ **Automatic:** Use this to set the phone to automatically search for and select one of the cellular networks available in your area. The phone will default back to **Automatic** if it is switched off.

- ▶ **Manual:** If you want to select the desired network manually from a list of network, you can activate this function. If the connection to the manually selected network is lost, the phone will sound an error tone and ask you to select a network again. The selected network must have a roaming agreement with your home network, that is, the operator whose SIM card is in your phone. The phone will let you select another network if the phone fails to access the selected network. If you switch off the phone, the phone will be reset to **Automatic**.
- ▶ **Preferred:** You can set a list of preferred networks the handset should attempt to register with first, before attempting to register to any other networks. This list is created from the handset's predefined list of known networks.

Band selection

Menu 3-5-2

EGSM/DCS

According to depending on Network situation, you can select EGSM/DCS.

PCS only

According to depending on Network situation, you can select PCS only.

GPRS

Menu 3-6

GPRS(General Packet Radio Service) is a technology that allows mobile phones to be used for sending and receiving data over the mobile network. GPRS is a data bearer that enables wireless access to data network such as the Internet.

Before you can use GPRS technology.

- ▶ You need to subscribe to the GPRS service.
For availability and subscription to GPRS service, contact your network operator or service provider.
- ▶ You need to save the GPRS settings for the applications used over GPRS.

If you select Switch On and you are in a network that supports GPRS, the phone registers to the GPRS network and sending short messages will be done via GPRS. Also, starting an active packet data connection, for example, to send and receive a picture message, is

quicker. If you select When needed, the phone will use a GPRS connection only if you start an application or action that needs it. The GPRS connection is closed after it is no longer required by any application.

- **Note** If there is no GPRS coverage and you have chosen Automatic, the phone will periodically try to establish a connection.

Memory status

Menu 3-7

You can check the size of free memory and available memory of text messages.

Reset settings

Menu 3-8

You can reset your phone to its default configuration. To do so, proceed, as follows.



1. Select the **Reset settings** menu option.
2. Enter the 4-digit security code.

- **Note** The security code is preset to 0000.

The KG220 has a built-in camera. It supports Zoom, Colour/Grey settings, and Multi burst functions.

Take pictures



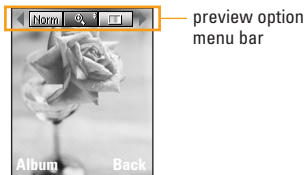

Menu 4-1

Press the Menu key () and select **Camera – Take picture**. Or, press the camera key () in standby mode. The camera module opens and you'll see the view to be captured.

Before shooting, you can set the following values.



preview option menu bar

- 1. Digital zoom** (): x1, x2, x3, x4
- 2. Tone** (): Colour, Sepia, Black and white
- 3. Brightness** (): +2, +1, 0, -1, -2
- 4. Timer** (): Off, 3 sec., 5 sec.

5. Memory (): Shows the current memory status.

Note If the memory is full, "Memory full" message is popped up and you cannot save a photo. Create space by deleting old photos in **Photo album**.

6. Resolution (): 640x480(VGA), 320x240(QVGA), 160x120(QQVGA). 48x48(Address book)

7. Image quality (): Fine/Normal/Basic

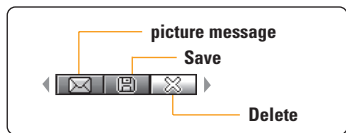

1. Centre the desired option menu using the left/right navigation keys.
2. Select the desired value with the up/down navigation keys.
3. After finishing all the settings, focus on the subject to capture and press the Camera key or OK key. With a click, the image is captured and the following menu bar appears.

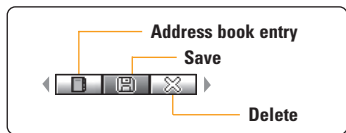

Note When the resolution is set to 48x48 (Address book), the following menu bar appears.



If **Auto save** is set to **Yes**, the captured image is automatically saved without displaying the above menu bar.

- To save the image, centre the “” and press the OK key. If you don't want to save the image, centre the “” and press the OK key.



You can send the image via picture message by selecting “”.

For further information regarding picture message writing, refer to page 54-55.

After taking a photo in 48x48 (Address book), you can directly save the image in the address book by selecting “”.

Take continuously

Menu 4-2

You can take the maximum of 9 photos subsequently at the same time. After taking a photo, you can view it by pressing , . You can also save it by pressing .

- Reference** If you set 320x240 in resolution you can take only 6 pictures. If you set 160x120, it can take 9 pictures.



Settings

Menu 4-3

Auto save (On/Off)

Menu 4-3-1

If you select On, photos taken will automatically be saved.

Clear album

Menu 4-3-2

You can delete all the album.

Press the Menu key () and select **Messages** using navigation keys.





New messages

Menu 5-1

Write text message

Menu 5-1-1

Your phone receives voice mail notification messages and Short Message Service(SMS) messages. Voice mail and SMS are network services. Please contact your network operator for more information.

When the  icon appears, you have received voice mail. When the  icon appears, you have received a new text message. If the message memory is full, a message is displayed, the  icon change with  and you cannot receive any new messages. Use the **Delete** option in the **Inbox** menu to delete obsolete messages. Once there is space in the message memory, any undelivered SMS messages will be received (provided sufficient space is available).

1. Key in your message. For details on how to enter text, refer to page 25 through 28 (Entering Text).

2. After you complete the message, to select the required option, press the left soft key  [Options].

The following options are available.

- ▶ **Send:** Enter the number or select the number from the phonebook or the recent number. You can send a message up to 6 phone numbers at a time. Press the left soft key [Options]. The following options will be displayed.
 - ① Contacts
 - ② Recent numbers
- ▶ **Save:** Allows you to save the message so that it can be sent later.
- ▶ **Font:** Sets the font size and style.
- ▶ **Colour:** You can select colour of foreground and background.
- ▶ **Alignment:** You can set the position of the message - Left, Centre or Right
- ▶ **Add T9 dictionary:** You can add your own word. This menu can be shown only when the edit mode



Messaging

is Predictive.

- ▶ **T9 languages:** Select the language for T9 input mode. You can also deactivate T9 input mode by selecting 'T9 off'.
 - ▶ **Exit:** If you select this whilst writing a message, you will be taken back to the message menu. Also the written message will not have been saved.
3. You can also send attachments with the message by pressing the right soft key [Insert], while you're entering a message.
- ▶ **Symbol:** You can attach special characters.
 - ▶ **Image:** You can send and receive text messages that contain pictures. Several preset pictures are available in the phone and they can be replaced with new ones received from other sources.

- ▶ **Sound:** If available, you can attach a sound available for a short message.
- ▶ **Text template:** You can use text templates already set in the phone.
- ▶ **Contacts:** You can add phone numbers in the message.
- ▶ **My business card:** You can attach your name card.

Write picture message

Menu 5-1-2

A picture message can contain text, images, and/or sound clips. This feature can be used only if it is supported by your network operator or service provider. Only devices that offer picture message can receive and send picture message.

1. Key in the text message. Using the right soft key, you can input symbols, numbers and emoticons. After the text message input, press the left soft key [Done].
2. Add an image and/or sound. You can move to the other feature using the up/down navigation.
3. You can add a slide using the left soft key [Options].

4. Press the left soft key [Options]. The following options are available.

- ▶ **Send:** You can send picture messages to multiple recipients, prioritise your message, and you make the validity period as well.
- ▶ **Preview:** Displays the picture message you wish to send.
- ▶ **Save:** Saves the picture message in draft or as a template.
- ▶ **Add slide:** Adds a slide before or after the current slide.
- ▶ **Move to slide:** Moves the next or previous slide.
- ▶ **Delete slide:** Deletes the selected slide.
- ▶ **Set slide format**
 - **Set timer:** You can set the timer for slide, text, picture, sound.
 - **Swap text and image:** You can switch the position of picture and text of the message.

- ▶ **Remove media:** You can remove picture or sound in the slide.
 - ▶ **Add T9 dictionary:** You can add your own word. This menu can be shown only when the edit mode is Predictive.
 - ▶ **T9 languages:** Select the language for T9 input mode. You can also deactivate the T9 input mode by selecting 'T9 off'.
 - ▶ **Exit:** If you select this whilst writing a message, you will be taken back to the message menu. Also the written message will not have been saved.
5. Press the right soft key [Insert]. You can insert symbol, photo, image, sound, text template, contacts, my business card, and record voice. and In addition, you can write the message by searching the phonebook.



Inbox





Menu 5-2

Received text messages and page messages can be searched and the contents can be viewed.

Received messages are displayed in date order.

You will be alerted when you have received messages. They will be saved in the Inbox. You can identify each message by icons. For details, see the icon description below.



If the phone has 'No space for messages', you can make space by deleting messages, media and applications.

Icon	Icon directive
	Read SIM message
	Unread SIM message
	Read message
	Unread message

Note SIM message refers the message saved in the SIM memory. And the network distinguishes an incoming message into the SIM message or just message.

Each received message has the following options available. Press the left soft key [Options].

- ▶ **View:** You can view the received messages.
- ▶ **Reply:** Replies to the received message.
- ▶ **Forward:** Forwards a received message to other recipients.
- ▶ **Return call:** Calls the sender's phone.
- ▶ **Delete:** Deletes the selected message from the Inbox.
- ▶ **Information:** Displays information about the received message.
- ▶ **Delete all:** Deletes all messages in the folder.

Icon	Icon directive
	Read picture message
	Unread picture message
	Notification for MMS

- **Reply:** Replies to the sender.
- **Reply all:** Replies to the all of the sender on picture message.
- **Forward:** Forwards the selected message to other recipients.
- **Return call:** Call back to the sender.
- **Delete:** Deletes the current message.
- **Get:** Extracts a number, image, sound, email and Url from the message. These will be saved in My folder, Phonebook, or bookmarks on [Options].
- **Information:** Displays information about received messages; Sender's address, Subject (only for picture message), Message date & time, Message type, Message size.

Drafts

Menu 5-3

In this menu, you can see the message list saved as draft. Scroll through the list using the up/down navigation keys. Each draft has the following options.



- ▶ **View:** Views the message saved as a draft.
- ▶ **Edit:** Edits the message before sending.
- ▶ **Delete:** Deletes the current message.
- ▶ **Information:** Check the date, time, type, and file size of the message.
- ▶ **Delete all:** Deletes all message in draft.

Outbox

Menu 5-4

You can view the list and contents of sent messages in this menu and can also verify if the transmission was successful.

The following options are available.







Icon	Icon directive
	Sent SIM message
	Sent message



Messaging

- ▶ **View:** Shows the selected message.
- ▶ **Forward:** Forwards the current message to other recipients.
- ▶ **Delete:** Deletes the selected message from the Outbox.
- ▶ **Information:** Displays information about the sent messages.
- ▶ **Delete all:** Deletes all messages in the Sent folder.

Use this to see sent messages. For each sent message, you can see the delivery status.

Icon	Icon directive
	Sent
	Unsent message
	Confirmed Sent message
	MMS Sent
	Unsent MMS
	Confirmed Sent MMS

- **Delete:** Deletes the current message.
- **Forward:** Forwards the current message to other recipients.
- **Information:** Displays information about the outgoing messages: Subject (only for picture message), Message date & time, Message type, Message size.

Listen to voice mail

Menu 5-5

This menu provides you with a quick way of accessing your voice mailbox (if provided by your network). Before using this feature, you must enter the voice server number obtained from your network operator.

When a new voice message is received, the  symbol will be displayed on the screen. Please check with your network provider for details of their service in order to configure the handset correctly.

Info messages

Menu 5-6

Info service messages are text messages sent by the network to mobile phone users. They provide general information such as weather reports, traffic news, taxis, pharmacies, and stock prices. Each type of

information is associated with a number, which can be obtained from the network operator. When you receive an info service message, a popup message will indicate a new message receipt or the info service message will be displayed directly. In standby mode, the following options are available when viewing info service messages.

Read Menu 5-6-1

When you have received broadcast messages and select **Read** to view the message, it will be displayed on the screen.

Topics Menu 5-6-2

To create new topics, select **Add new**. If you already have topics, you can deactivate, edit, or delete them by using the left soft key [Options].

Templates Menu 5-7

There are pre-defined messages in the list. You can view and edit the template messages or create new messages. Two types of templates are available: Text and Multimedia.

Text Menu 5-7-1

- **Please call me back.**
- **I'm late. I will be there at...**
- **Where are you now?**
- **I'm on the way.**
- **Top urgent. Please contact.**
- **I love you.**

The following options are available.

- ▶ **Edit:** Use this to write a new message or edit the selected template message from the text template list.
- ▶ **Write messages**
 - **Write text message:** Use this to send the selected template message by SMS.
 - **Write picture message:** Use this to send the selected template message by MMS.
- ▶ **Add new:** Use this to create new template.
- ▶ **Delete:** Deletes the template.



Picture message

Menu 5-7-2

- ▶ **Preview:** Displays the draft picture message.
- ▶ **Save:** Saves picture message in draft form or as templates.
- ▶ **Add Slide:** Adds a slide before or after the current slide.
- ▶ **Move to slide:** Moves to next or previous slide.
- ▶ **Delete slide:** Deletes the highlighted slide.
- ▶ **Set slide format:** Sets the timer for slide, text, or to align the message contents right, left, top and bottom.
- ▶ **Add T9 dictionary:** You can add our own word. This menu can be shown only when the edit mode is Predictive.
- ▶ **T9 languages:** Selects T9 input mode.
- ▶ **Exit:** Exits the menu.

Settings

Menu 5-8

Text message

Menu 5-8-1

▶ Message types:

Text, Voice, Fax, Natl. paging, X.400, E-mail, ERMES

Usually, the type of message is set to **Text**. You can convert your text into alternative formats. Contact your service provider for the availability of this function.

- ▶ **Validity period:** This network service allows you to set how long your text messages will be stored at the message centre.
- ▶ **Delivery report:** If you set to **Yes**, you can check whether your message is sent successfully.
- ▶ **Reply via same service centre:** When a message is sent, it allows the recipients to reply and charge the cost of the reply to your telephone bill.
- ▶ **SMS centre:** If you want to send the text message, you can receive the address of SMS centre through this menu.

Picture message

Menu 5-8-2

- ▶ **Priority:** You can send the message after setting the level of priority: High, Normal and Low.
- ▶ **Validity period:** This network service allows you to set how long your text messages will be stored at the message centre.
- ▶ **Delivery report:** If it is set to Yes in this menu, you can check whether your message is sent successfully.
- ▶ **Auto retrieve**
 - On:** The messages are downloaded automatically on receipt.
 - Off:** Requires to confirm the message which you want to download.
 - Home network only:** In home network, you can activate Auto download “On” menu, Otherwise, you can activate Auto download in roaming network when you set Off.
- ▶ **Accounts:** In order to download MMS from the server, you need to set up a CSD or GPRS data

connection. If you select picture message server, you can set URL for picture message server. You can set over 10 profiles to connect service.

- **Homepage:** This menu allows to connect MMS centre (MMSC).
- **Bearer**
 - **Data**
 - **GPRS**
- **Data settings:** Appears only if you select Data settings as a Bearer\service.

IP address

Dial number: Enter the telephone number to dial to access your WAP gateway.

User ID

Password

Call type: Select the type of data call, Analogue or Digital (ISDN).



Messaging

Call speed: The speed of your data connection 9600.

Linger time: You need to enter timeout period. After entering that, the WAP navigation service will be unavailable if any data is not input or transferred.

- **GPRS settings:** The service settings are only available when GPRS is chosen as a bearer service.

IP address

APN: Insert APN (Access Point Name) of GPRS.

User ID

Password

- **Proxy settings**

- **Proxy:** On/Off

IP address: Input the IP address of the Proxy server you access.

Port: Input port number of the proxy.

- **DNS settings:** Insert the primary and secondary

DNS if it is required by the network operator.

▶ Permitted message types

Personal: Personal message.

Advertisements: Commercial message.

Information: Necessary information.

Voice mail centre

Menu 5-8-3

You can receive the voicemail if this feature is supported by your network service provider. When a new voicemail is arrived, the symbol will be displayed on the screen. Please check with your network service provider for details of their service in order to configure the phone accordingly.

1. Hold down  key in standby mode.
2. You can check the following submenus.

▶ **Home:** You can listen to voice mails by selecting **Home**.

▶ **Roaming:** Even when you are in abroad, you can listen to voice mails if roaming service is supported.

Info message

Menu 5-8-4

▶ Receive

- **Yes:** If you select this menu, your phone will receive Info service messages.
- **No:** If you select this menu, your phone will not receive Info service messages any more.

▶ Alert

- **Yes:** Your phone will beep when you have received Info service message numbers.
- **No:** Your phone will not beep even though you have received info service messages.

- ▶ Languages:** You can select the language you want by pressing [On/Off]. Then, the info service message will be shown in the language that you selected.

Service message

Menu 5-8-5

You can set the option whether you will receive the message or not.



One click to your new Orange World

Just one click on your new KG220 transports you to the latest games, ringtones and sports news from around the world.

Find your nearest cashpoint then pick out a bar to blow your wages in, or simply curl up on the sofa and read about your favourite celebrities. Or, if you're feeling lucky, why not enter one of our great competitions. Whatever your mood, you're bound to find something of interest in your Orange World, so take the leap and get exploring now!

To enter Orange World press Orange. Orange World will open. Scroll down the page and press Select when you come to a link you want to visit. Channels enables Orange to suggest links that you'll enjoy, the suggestions we make are based on your phone and the day of the week. For example, on a Saturday we may suggest sport to give you quick access to football results.

Use Channels to personalise your phone by downloading new ring tones, wallpapers, or the latest games, including some of the biggest games around

such as Fifa Football and Tiger Woods Golf. You can even send Purple Ronnie greeting cards to send a surprise message to your friends. You can also access services from other providers such as the BBC and RAC.

How to create your own Orange World

The great thing about using Orange World is that you can constantly update it to suit your interests. When you first enter Orange World, spend a minute or two completing the Orange World wizard, which will ask you about your interests in order to provide the most relevant services to you. To set up your Orange World wizard, click the link under Your Page. Once you have finished personalising, use the Your Page link to quickly go to services which are of interest to you.

You can add or delete links to Your Page using the simple options provided. A suggestion for a link that might be useful will also appear at the top of the Orange homepage each time that you begin browsing.

How to find your way using Orange World

There's nothing more annoying than being lost or not having the right number to hand. You can now put these frustrations behind you with a dedicated Find feature which will show you where you are or take you to a list of sites, such as Time Out, to help you find the information you need to keep working or partying.

For example, use Orange World to find the nearest cash point to the pub you arranged to meet your friends in. Once you're there, use the Find feature to find the local cinema, and grab a cab number to organise a lift there. It's simple, quick, and above all convenient. Try it now to see what you could be doing tonight.



In Profiles, you can adjust and customise the phone tones for different events, environments, or caller groups. There are five preset profiles: **Normal**, **Vibrate only**, **Silent**, **Loud**, and **Headset**. Each profile can be personalised. (Except Vibrate , Silent menu)

Press the Menu key () and select **Profiles** using navigation keys.

Changing the profile

Menu 7-X-1

1. A list of profiles is displayed.
2. In the **Profile** list, scroll to the profile you want to activate and press the left soft key [OK] or OK key.
3. Then, select **Activate**.

Customising profiles - Personalise

Menu 7-X-2

Scroll to the desired profile in the Profile list. After pressing the OK key or the left soft key, select **Personalise**. The profile setting option opens. Set the option as required.

- ▶ **Call alert type:** Set the alert type for incoming calls.
- ▶ **Ring tone:** Select the desired ring tone from the list. Scroll through the list using up/down navigation keys. You can hear the desired tone prior to making a selection.
- ▶ **Ring volume:** Set the volume of the ringing tone.
- ▶ **Message alert type:** Set the alert type for messages.
- ▶ **Message tone:** Select the alert tone for messages.
- ▶ **Keypad tone:** Select the desired keypad tone.
- ▶ **Keypad volume:** Set the volume of keypad tone.
- ▶ **Flip tone:** Set the alert tone when opening the flip.
- ▶ **Effect sound volume:** Set the volume of effect sound.
- ▶ **Power on/off volume:** Set the volume of the ringing tone when switching the phone on/off.

Customising profiles - Rename

Menu 7-X-3

You can rename a profile and give it any name you want. **Vibrate only**, **Silent** and **Headset** profiles cannot be renamed.

1. To change the name of a profile, scroll to the profile in the profile list and after pressing the OK key or the left soft key, select **Rename**.
2. Key in the desired name and press the OK key or the left soft key [Save].



You can connect to game downloads on the mobile Internet by using your WAP browser or Java, if this service is available from your service provider. Check with your service provider for availability and details for use.

Photos Menu 8-1

You can view and send a picture. In addition, you can set the window as a background.

- ▶ **Multi view:** You can view the maximum of 6 thumbnails in a screen.
- ▶ **Write picture message:** You can send a picture through MMS. Maximum file size is 100 kb.
- ▶ **Set as wallpaper:** You can set a picture as a wallpaper.
- ▶ **Slide show:** This menu allows you to view as a slide show automatically.
- ▶ **Rename:** You can edit the title of picture.
- ▶ **Delete:** You can delete a picture.
- ▶ **Information:** You can view the information about Title, Size, Date and Time you've taken.
- ▶ **Protection:** You can lock the picture for deleting in mistakes in this menu.

Images Menu 8-2

You can send the message with an image, and set it as a wallpaper.

Sounds Menu 8-3

You can send the message with a sound, and set it as a ring tone.

Games & Apps Menu 8-4

You can access a great selection of games on your phone. These games are different to the downloadable games as you require you to be connected while you are playing.

- **Note** After downloading any Java game, press "Ok" Key (OK) to save it in the root folder.

My games & more Menu 8-4-1

- **Default Games:** In this menu, you can manage the Java applications installed in your phone. You can play or delete downloaded applications, or set the connect option. The downloaded applications are organised in folders.

Press the left soft key  [Select] to open the selected folder or launch the selected midlet.

After selecting a folder, press [Options] and then sub menus available to several options are displayed.

▶ **Open:** You can see the stored games.

▶ **New folder:** Create a new folder.

Accounts

Menu 8-4-2

This menu contains the same settings of the Internet menu. In fact, in order to download new applications, a WAP connection is needed.

More pictures

Menu 8-5

You can also download more pictures on your phone by using network service.

More ringtones

Menu 8-6

You can also download more ringtones on your phone by using network service.

More games

Menu 8-7

You can also download more games on your phone by using network service.

Java™ is a technology developed by Sun Microsystems. Similar to the way you would download the Java Applet using the standard MS Internet Explorer browsers, Java MIDlet can be downloaded using the WAP enabled phone. Depending on the service provider, all Java based programs such as Java games can be downloaded and run on a phone. Once downloaded, the Java program can be viewed in the **My games & more** menu where you can select, execute, or delete. The Java program files saved in the phone are in .JAD or .JAR format.

- ⓘ **Note** The JAR file is a compressed format of the Java program and the JAD file is a description file that includes all detailed information. From the network, prior to download, you can view all detailed file descriptions from the JAD file.
- ⓘ **Caution** Only J2ME (Java 2 Micro Edition) based programs will run in a phone environment. The J2SE (Java 2 Standard Edition) based programs will only run in a PC environment.
- ⓘ **Option** Some Java applications may require a data connection to be made. Select this to set the connecting options.



Press the Menu key () and select **More** using navigation keys.

Calendar





Menu 9-1

Calendar

Menu 9-1-1

When you enter this menu a Calendar will be displayed. The month and year are shown at the top of the screen. Whenever you change the date under the Settings menu, the calendar will update automatically. The current date will be highlighted in orange color and any schedule will be indicated with a any schedule will be indicated at the bottom right hand corner of the corresponding square. An audible alarm can be set for memo's and reminders.

To change the day, month, and year.



Key	Description
	Yearly
	Monthly
	Weekly
	Daily

In the scheduler mode, press left soft key ( [Options]) as follows;

- ▶ **Add new:** Allows you to add a new schedule for the chosen day. Input the subject and then press the left soft key ( [OK].
- ▶ **View:** You can refer to a detailed schedule, that is the whole contents of the schedule configured by you.
- ▶ **View all:** You can refer all of the schedule.
- ▶ **Delete past:** You can delete the past schedule that is no longer required.
- ▶ **Delete all:** You can delete all notes.

Memo

Menu 9-1-2

1. Select the Memo by pressing the left soft key ( [OK].
2. If the entry is empty, add new by pressing the left soft key ( [Add].
3. Input the memo and then press the left soft key ( [OK].





- Note** If you want to change the text input mode, press the  in order.

Alarm clock

Menu 9-2

There are 5 alarm clocks available. Set the alarm to ring at a specific time.

After selecting an alarm clock using the left soft key [Select].

-  **Alarm on/off:** Select On using the left/right navigation key. To deactivate the alarm function, select Off.
-  **Alarm time:** Enter the alarm time using the numeric keys.
-  **Repeat:** Select the desired one from Once, Mon~Fri, Mon~Sat, and Everyday using the left/right navigation key.
-  **Alarm melody:** Select the desired alarm melody using the left/right navigation key.
- Press the left soft key [OK].
- You can edit the alarm clock name. After keying in

the name, press the left soft key [OK].

When an alarm function is activated, “” is shown in standby mode.

When the alarm time is reached, it sounds the alarm melody.

- ▶ To turn off the alarm, press the right soft key [Quit].

Calculator

Menu 9-3



Using this feature, you can use the phone as a calculator. The calculator provides the basic arithmetic functions: addition, subtraction, multiplication and division. (You can enter numbers up to the second decimal place)

Using the calculator

- Enter the first number using the numeric keys.
- Press the corresponding navigation key to select a mathematical function.



More

- ❗ **Note** To erase any mistakes and clear the display, press the  key.
To include a decimal point, press the  key.
To include a minus sign, press the the  key.
- 3. To calculate the result, press the left soft key [Result] or OK key.
- 4. After calculation, press the left soft key [Reset] to return to the initial state.

World time

Menu 9-4

You can check the current time of Greenwich Mean Time (GMT) and major cities around the world, using the left/right navigation keys.

The screen shows the city name, current date and time.

To select the time zone in which you are located, proceed as follows:

1. Select the city corresponding to your time zone by pressing the left/right navigation keys one or more times. The local date and time are displayed.
 2. If you want to change the time display in standby mode to the selected time, press the left soft key [Set]. And select **Set**.
- ❗ **Note** The time zone setting of each city in World time menu may be affected by network condition.

Unit converter

Menu 9-5

This converts any measurement from one unit to another.

There are 4 types that can be converted into units: Length, Area, Weight and Volume.

1. Select one of four unit types by pressing the left soft key [Unit].
2. Move to the current unit section by pressing the down navigation key.
3. Select the unit you want to convert using the left/right navigation keys.

4. Move to the Convert unit section by pressing the down navigation key.
 5. Select the unit you want to convert to, using the left/right navigation keys.
 6. Input numbers using the numeric keys. Conversion is calculated automatically.
- 📌 **Note** You can input a decimal number by pressing the  key.

Voice recorder

Menu 9-6

You can record a memo. You can record up to 10 memos, 20 seconds each

You can play or delete the recorded memo using the left soft key [Option] key.

- 📌 **Note** In standby mode, you can go directly to the Voice recorder menu by pressing the down navigation key.

Record

1. Select **Voice recorder- Record** menu.
2. Once recording is started, the message 'Recording...' and the remaining time is displayed.

3. When you finish recording, press left soft key [Save].

- 📌 **Note** If all memo locations are full, you must delete an old memo before recording a new one.

View list

You can Play, or Delete the recorded memo.

- ▶ **Playback:** Allows you to play back all memos recorded, starting with the most recent memo. The screen displays the Date and time when the memo was recorded.
- ▶ **Send by picture message:** You can send the voice memo with picture message.
- ▶ **Delete:** Allows you to delete a specific memo.
- ▶ **Delete all:** Allows you to delete all memos. Press the left soft key [Yes] to confirm.





Please check to see if any problem which you may have with your phone is described here before taking it for service or calling a service engineer.



Q How do I view the list of outgoing calls, incoming calls and missed calls?

A Press  .

Q How do I clear all call history?

A Press the left soft key and then    .

Q How do I view all numbers saved in the memory?

A Press the left soft key and then   .

Q  does not disappear from the screen.

A Check whether you are in a service area. If you continue to see , turn off the power and wait for approximately 2 minutes before turning it back on. If there is no change, relocate to another area and check again.

Q Connection is poor or is not audible in certain areas.

A In certain areas, signal strength can vary dramatically. Try moving to a different location. Heavy network traffic may affect the ability to connect, or the stability of the call.

Q Connection is poor even when established.

A In certain areas, signal strength can vary dramatically. Try moving to a different location. Heavy network traffic may affect the ability to connect, or the stability of the call.

Q LCD does not turn on.

A Remove and replace the battery and turn on the power. If the phone still does not turn on, charge the battery and try again.

- 
- Q** An echo can be heard during connection with a certain telephone in a certain area.
- A** It is called 'Echo Phenomenon'. It occurs if the volume is too high or caused by special properties (semi electronic telephone exchange) of the machine on the other end.
- Q** The phone gets warm.
- A** During long calls, or if games/Internet are used for a long time, the phone may become hot. This is perfectly normal and has no effect upon the life of the product or performance.
- Q** The bell does not ring, or lamp or LCD blinks only.
- A** The phone is set to 'Vibrate' or 'Silent' in the Profiles menu. Please select 'Normal' or 'Loud'.
- Q** Standby duration of the phone gradually becomes shorter.
- A** Batteries have a limited life. When the battery lasts for half its original time, it requires replacement. Only use authorised replacement parts.
- Q** Usage time of battery becomes shorter.
- A** If the battery time is short, it may be due to the user environment, or large volume of calls, or weak signals.
- Q** No number is dialled when you recall a phonebook entry.
- A** Check that the numbers have been saved correctly, by using the phonebook Search feature. Resave them, if necessary.



Q You cannot be contacted.

A Is your phone switched on ( pressed for more than three seconds)? Are you accessing the right cellular network? Have you set an incoming call barring option?

Q I cannot find the lock, PIN, or PUK code, or password?

A The default lock code is **'0000'**. If you forget or lose the lock code, contact your phone dealer. If you forget or lose a PIN or PUK code, or if you have not received such a code, contact your network service provider.

There are a variety of accessories available for your mobile phone. You can select these according to your personal communication requirements. Consult your local dealer for availability.

Battery

Standard battery is available.



Headset

Allows hands-free operation. Includes earpiece and microphone.



Supplied adapter

This adapter lets you charge the while at home or in the office.



- Note**
- Always use genuine LG accessories. Failure to do this may invalidate your warranty.
 - Accessories may be different in different regions; please check with our regional service company or agent for further enquiries.



General

Product name: KG220

System : GSM 900 / DCS 1800 / PCS 1900

Ambient temperatures

Max: +55°C

Min : -10°C

Declaration of Conformity



LG Electronics

Suppliers Details

Name

LG Electronics Inc

Address

LG Twin Towers 20, Yeouido-dong, Yeongdeungpo-gu,
Seoul, Korea 150-721

Product Details

Product Name

E-GSM 900 / GSM / 1800 / 1900 Tri Band Terminal Equipment

Model Name

KGZ20

Trade Name

LG

CE 0168

Applicable Standards Details

R&TTE Directive 1999/5/EC

EN 301 489-01 / EN 301 489-07

EN 60950-1 : 2001

EN 50360/EN 50361 : 2001

3GPP TS 51.010-1, EN 301 511 V9.0.2

Supplementary Information

The conformity to above standards is verified by BABT.

Declaration

I hereby declare under our sole responsibility
that the product mentioned above to which this
declaration relates complies with the above mentioned
standards and Directives

Name

Jin Seog, Kim / Director

Issued Date

23,Jan. 2006

LG Electronics Inc, Amsterdam Office
Veluwezoom 15, 1327 AE Almere, The Netherlands
Tel : +31 - 36- 547 - 8940, e-mail : seokim @ lge.com

Signature of representative