

***User Manual***

**spice**  
**S-5420**

Copyright 2009 Spice Mobiles Ltd.



## **Welcome**

Thank you for purchasing spice S-5420 mobile handset. This attractive phone comprises of 2.2 inches Big screen with VGA camera, FM radio, Music player, Mobile Tracker, Fun Spice - Ibibo, NgPay, Opera Mini, Nimbuzz, Reuters etc. Private menu and Panic button, The phone comes up with the USB connectivity.

Our advanced technology is designed to grow with users communications needs so that one day you will be able to rely entirely on users Handset to stay connected.

This guide will familiarize user with our technology and new Handset phone through simple, easy to follow instructions. If users have already reviewed the Quick Start Guide, which was packaged with new Handset, then user is ready to explore the advanced features outlined in this guide.

If users have not read Quick Start Guide, go to Section One Getting Started. This section provides all the information user needs to quickly activate phone, and much more.

We congratulate on your choice.

Disclaimer : This User Manual is being provide for better understanding of S-5420 feature and functions. Spice will not be responsible for any printing errors in this user manual.

# Safety Information

Please read and understand the details which are both safe to you and your environment. Failure to observe these instructions may lead to suspension of cellular phone services to the user, or some legal action

## Important information for parents:

**Please read the operating instructions and safety precautions carefully before use. Explain the content and the hazards**



### Emergency Calls (SOS)

Emergency call can be made from your cellular phone even without a SIM in the network service area.



### Traffic Safety

Please do not use your cellular phone while driving; find a safe place to stop first.







### Switch off in Hospital

The use of cellular phones may interfere with the functionality of some possible insufficiently protected medical devices in hospital.



### Switch off in Airplane

The use of cellular phone in an aircraft may be dangerous to the operation of the aircraft, disrupt the cellular network and may be illegal.

	<p><b>Switch off in Gasoline Station and Explosive Site</b></p> <p>It is advisable that users turn off cellular phone when refueling is in progress, users are reminded to observe restrictions on the use of radio equipment in fuel depots.</p>
	<p><b>Operating Environment</b></p> <p>Mobile radio transmitting equipment, including cellular phones, may be subject to interference and may cause danger. Switch off your phone whenever it is forbidden to use it.</p>
	<p><b>Use Sensibly</b></p> <p>Do not hold the phone to your ear when it rings or when you have switched on the hand free function. Otherwise you risk serious permanent damage to your hearing.</p>
	<p><b>Appropriate Maintenance</b></p> <p>Only qualified and authorized personnel should service your cellular phone. Faulty installation or repair may be hazardous.</p>
	<p><b>Replace</b></p> <p>You may only open the phone to replace the battery and SIM card. You must not open the battery under any circumstances. All other changes to this device are strictly prohibited and will invalidate the operating license.</p>



### **Interference Noticed**

The phone may cause interference in the vicinity of TV sets, radios and PCs.

## **Safety Warnings**



### **Accessories**

Use only accessories and charging devices approved by the phone manufacturer! Otherwise you risk serious damage to health and property. The battery could explode, for instance.



### **Power Voltage**

The mains voltage specified on the power supply unit (Volt) must not be exceeded. Otherwise the charging device may be destroyed.



### **Waste Disposal**

Dispose of worn out batteries and phone in accordance with local provisions!

spice  
S-5420

## **Rechargeable Battery**

- If battery is over discharged the handset will need to pre-charge less than 10-20 minutes.
- Avoid accidental shorts across the contacts of battery by metal parts. Shorts can cause rapid discharge currents that can damage the battery, the part that creates the short or cause injuries.
- Prevent extreme low and high ambient temperatures for the battery. Therefore, do not place battery near a heater or on the car dashboard.
- Do not open, penetrate or otherwise physically damage the battery.
- Do not incinerate battery.

## **Technical detail**

Network : 900 / 1800 / 1900 mHz

Dimension : 112 x 49 x 12.8 mm

Weight : 95 g

Battery : 3.7 V / 750 mAh

Talk time : 2.5 Hr\*

Standby time : 200 Hr\*

Disclaimer : Standby and talk times are estimates only and possible under optimal network conditions. Actual times may vary depending on SIM card, operating temperature, battery age and condition, network conditions, features selected and used, and many other factors, and may be shorter than the mentioned above.

# Contents

<b>WELCOME</b> .....	ii
<b>SAFETY INFORMATION</b> .....	iii
<b>SAFETY WARNINGS</b> .....	V
<b>GETTING STARTED</b> .....	6
SIM Card and Battery Information.....	6
Insert SIM Card.....	6
Insert Memory Card.....	6
Insert Battery.....	6
Charge Battery.....	7
<b>YOUR PHONE</b> .....	8
Front / Back / Side View of Phone.....	8
Navigating Functions.....	9
Key Function List.....	10
Idle Mode.....	11
Main Menu.....	12
Listing of Functions.....	14
Personalizing your Phone.....	17
Display Language.....	17
Tone.....	17
Wallpaper.....	17
Navigator key.....	17
Activated Profile.....	18
Silent Mode.....	18
Writing Text.....	18
Multitap text input.....	18
Smart text input.....	19
Tips for writing text.....	19
Text Input Mode.....	20



Calling.....	21
Missed calls.....	22
To change the ear speaker volume during a call.....	22
To use loudspeaker during a call.....	22
To call emergency.....	23
Tip of call options.....	23
<b>MENU FUNCTIONS &amp; THEIR DESCRIPTIONS.....</b>	<b>26</b>
PHONEBOOK (MENU 1).....	26
Search.....	26
Smart search.....	27
Add new.....	27
Move.....	28
Move to private.....	29
Delete.....	29
Copy.....	29
Caller groups.....	30
Speed dials.....	30
Settings.....	31
Blacklist.....	33
MESSAGES (MENU 2).....	34
Write new.....	34
Inbox.....	37
Drafts.....	38
Outbox.....	39
Delete folder.....	39
Templates.....	39
Message settings.....	40
Memory status.....	43
Chat.....	43
Voice messages.....	44
Broadcast message.....	45

CALL RECORD (MENU 3)	46
Missed calls	47
Dialed calls	48
Received calls	48
Delete	48
Call duration	49
Call cost	49
SMS counter	50
GPRS counter	50
SETTINGS (MENU 4)	51
Display settings	51
Date and time	54
Phone settings	55
Call settings	57
Connection settings	61
Security setting	63
RestoreFactory	65
FUN SPICE (MENU 5)	66
FILE MANAGER (MENU 6)	73
SHORTCUTS (MENU 7)	75
MEDIA CENTER (MENU 8)	76
Camera	76
Media Player	82
Video Player	86
Video Recorder	88
Voice Recorder	90
Photo Gallery	90
FM radio	91
FM radio recorder scheduler	95
JAVA	95

ORGANIZER (MENU 9).....	96
Alarm clock.....	96
Calendar.....	96
To do list.....	97
Memo.....	98
World clock.....	98
Health.....	98
USER PROFILES (MENU 10).....	99
EXTRA (MENU 11).....	102
Calculator.....	102
Unit converter.....	102
Stopwatch.....	103
SERVICES (MENU 12).....	105
STK.....	105
WAP.....	106
Data account.....	111
TO USE MASS STORAGE (USB CABLE).....	112

## SIM Card and Battery Information

### *Insert SIM Card*

- The SIM card is inserted into the back of the phone underneath the battery.
- Press the knob and open the battery cover off.
- Remove the battery.
- Place the card inside the SIM cardholder such that the golden connectors are facing downwards.

### *Insert Memory Card*

- Use only compatible T-Flash (Micro SD) card with this device. Other memory cards, such Secure digital (SD) cards, do not fit in the T-Flash (Micro SD) card slot and are not compatible with this device. Using an incompatible memory card may damage the memory card as well as phone, and data stored on the incompatible card may be corrupted.
- The T-Flash (Micro SD) cardholder is the back of the phone underneath the battery.
- Place the T-Flash (Micro SD) card in the notch. Make sure that the T-Flash (Micro SD) card is properly inserted and that the golden contact area on the card is facing upwards.
- Close the cover of cardholder.

## ***Insert Battery***

### **[Warning]:**

1. If the battery is totally empty, charging icon or LED is not on. There fore, you should charge the battery maximum up to 10-20 minutes.
  2. If you turn off handset abnormally, please take out battery about 10 seconds then insert battery. Otherwise the battery will discharge and run out of power quickly
- Slide the battery into the cradle and press the battery down flat.
  - Place the back cover and slide it into place.

## ***Charging the battery***

- You must fully charge the battery before using your phone for the first time.
- Connect the lead from the travel charger to the socket on the left side of your phone.

## Front / Back / Side View of Phone

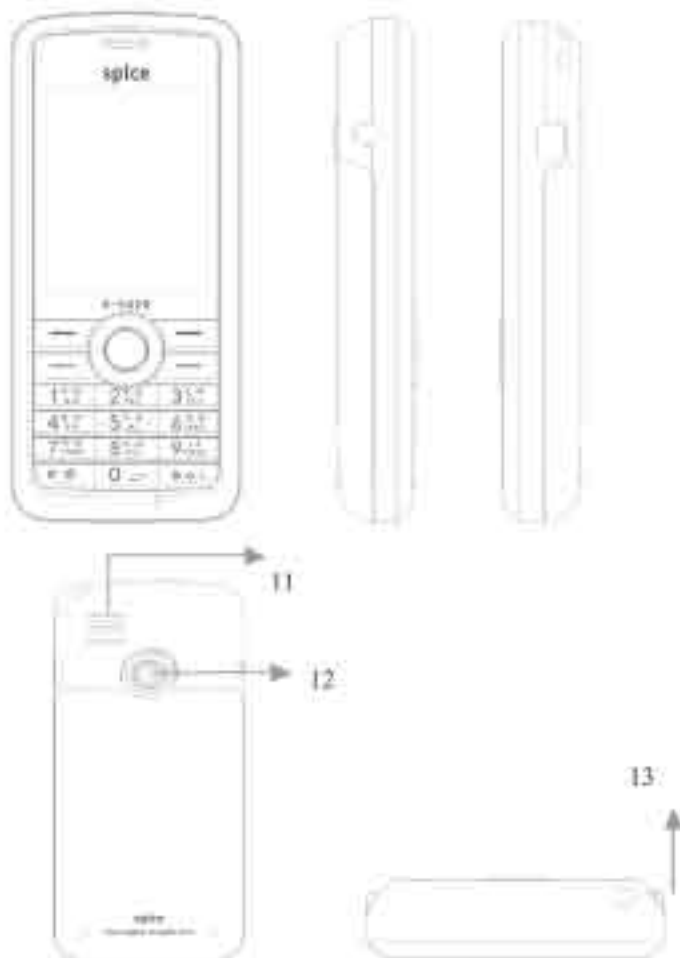



1	Ear speaker
2	Left soft key (Left selection key)
3	Answer key
4	Keypad
5	Display screen
6	Navigation key

7	Right soft key (Right selection key)
8	End key
9	Headphone jack
10	USB connector
11	Speaker
12	Camera
13	Microphone

## Navigating Functions

The main menus are shown as icons on the screen. Scroll to the highlight icon by pressing the navigation key up, down, right, left or center and select a function.



Navigating the menu by scrolling



- To access the menu press Menu.
- Scroll with  through the menu and press  left soft key to select highlight item
- Press right / left to move between the tabs.
- Press up / down / left / right to move the submenu.
- Scroll to a submenu item and select the one that you want.
- Press OK and enter a list of options. There are different alternatives in the list of options depending on where you are in the menu.
- Press Back, and go back one level in the menus.

Navigating the menu by numbering

- After entering Menu, you can access menu and submenu items by using their matching number. For example: Press key 3, you can access Call History setting.

## Key Function List

	<p>Power key End key</p>	<p>Switch phone on and off. Also, ends a call or Exit from any function and back to idle mode.</p>
	<p>Selection key Soft key</p>	<p>The function of the keys depends on the text shown on the display above the keys. For example, <b>Menu</b> and <b>Name</b> in idle mode.</p>
	<p>Navigation key</p>	<ul style="list-style-type: none"> <li>• Use for quick access to phone functions in idle mode.             <ul style="list-style-type: none"> <li>◆ Up: Launch Fun Spice WAP site.</li> <li>◆ Down: Access to the <b>Shortcuts</b> menu.</li> <li>◆ Left: Access to the <b>Message Writing</b> menu.</li> <li>◆ Right: Access to the <b>Camera</b> menu.</li> <li>◆ Center: Access to <b>Media Player</b></li> </ul> </li> <li>• Use for scrolling through names and numbers stored in the contacts or through the phone's menus, submenus, and option list.</li> </ul>

		[Note]: Navigation shortcut maybe different depends on personal setting in "Phone settings/ Navigator key".
	Send key Answer key	Make and answer calls; press in idle mode to see recent dialed calls.
	Number keypad	0-9 input number and character

## Idle Mode

When the phone is on, and you have not keyed in any characters, the phone is in idle mode.

























1. Top of the screen shows Essential Indicators.
2. This line displays the operator name.
3. This line shows date and time information.
4. To enter Menu press left soft key.
5. To enter Quick search of the contacts press right soft key.

# Main Menu



1.	Phonebook	7.	Shortcuts
2.	Messages	8.	Media center
3.	Call Record	9.	Organizer
4.	Settings	10.	User Profile
5.	Fun spice	11.	Extra
6.	File manager	12.	Services

## Essential Indicators

	Indicates signal strength.
	
	Shows handset current battery charge strength.
	Bluetooth feature is active.
	Indicates the phone keypad is locked.
	Indicates the current profile is General.
	Indicates the current profile type is Silent.
	Indicates the current profile type is Meeting.
	Indicates the current profile type is Outdoor.
	Indicates the current profiles type is Headset.
	The Alarm clock is set on.
	The Stopwatch function is on.
	Indicates "roaming".
	Indicates new SMS.
	Indicates new MMS.
	Indicates the Chat function.
	
	Indicates call forward is set on.
	
	
	Indicates GPRS is connected.
	Indicates Music player is in background playing.

# Phone Functions

<b>Phonebook</b>
Search
Smart search
Add new
Move
Move to private
Delete
Copy
Caller groups
Speed dials
Settings
Blacklist

<b>Messages</b>
Write new
Inbox
Drafts
Outbox
Delete folder
Templates
Message settings
Memory status
Chat
Voice messages
Broadcast message

<b>Call Record</b>
Missed calls
Dialed calls
Received calls
Delete
Call duration
Call cost
SMS counter
GPRS counter

<b>Settings</b>
Display settings
Date and time
Phone settings
Call settings
Connection settings
Security settings
RestoreFactory



<b>Fun Spice</b>
SpiceGang
Ibibo
NgPay
Opera Mini
Nimbuzz
Reuters
MGurujee
Voice Zone
Contacts Backup
Game
After Spice
Utilities

<b>File manager</b>
Phone
Card (Insert memory card and will reveal)

<b>Shortcuts</b>
------------------

<b>Media center</b>
Camera
Media player
Video player
Video recorder
Voice recorder
Photo gallery
FM radio
FM radio recorder
schedule
Java

<b>Organizer</b>
Alarm
Calendar
To do list
Memo
World clock
Health

<b>User profiles</b>
General
Silent
Meeting
Outdoor
Headset
Bluetooth

<b>Extras</b>
Calculator
Unit converter
Stopwatch

<b>Services</b>
STK
WAP
Data account



# Personalizing your Phone

## *Display Language*

- From Idle mode, press **Menu** and select **Settings / Phone settings / Language**, press **OK** to enter language list.
- Select a language and press **OK**.

## *Tone*

- From Idle mode, press **Menu** and select **Profiles / General / Customize/ Tone settings**, then select item enter to tone list.
- Select a ring tone and press **OK**.

## *Wallpaper*

- You can set wallpaper for the idle screen.
- From Idle mode, press **Menu** and select **Settings / Display settings / Wallpaper** press **OK** to enter option list.
- Select **Default** or **My folder** and link to image list.
- Select image and press **OK**.

## *Navigator key*

- Use predefined navigation key shortcuts to quickly reach certain function. Edit the navigation key shortcuts to suit your own needs. In idle mode, press up / down / left / right / center to go to a shortcuts menu, or directly to a function.
- To edit a navigation key shortcut, from idle mode, press **Menu** and select **Settings / Phone settings / Navigator key**, press **Edit** to enter shortcuts list.

- Select a menu function and press **OK** to be assigned to the navigation key.

## **Activated Profile**

- To access the list of profiles from idle mode, press **Menu**, then use Navigation key scroll to **User profiles** and press **OK**.
- Press **Options** key to activate the certain profile and press **OK**.



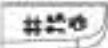

## **Silent Mode**

- You can switch the phone to Silent mode easy and quickly to avoid disturbing other people.
- Long press  in idle mode.

## **Writing Text**

There are two ways of writing messages, notes or name in contacts, Multitap text input and Smart text input mode.

### **Multitap text Input**

- Press a number key  to  all the characters of that keypad will be shown on the below area. Use navigation key left and right to choose the character that you wanted and press Select.
- When you are writing text, press either  to change input mode.
- The most common punctuation marks are available under the number key .

## Smart text Input





Smart text input mode is based on a built- in dictionary. And this input mode is only available for the modes and languages on the mode list. When you writing text, you can key in any letter with a single key press. The word changes after each keystroke.

- Start writing a word by using the keys 2<sup>1st</sup> to 9<sup>1st</sup>. Press each key only once for one letter. The word changes after each keystroke.
- Example: To write Happy when the predictive test mode is selected, press 4<sup>1st</sup> once for H, 2<sup>1st</sup> once for A, 7<sup>1st</sup> once for p, 7<sup>1st</sup> once for other p, and 9<sup>1st</sup> once for Y.
- When you have finished writing the word and it is correct, confirm it by press options.

## Tips for writing text

- ◆ To insert a space, press 0.
- ◆ To move the cursor to the left, right, down or up, press the Navigation key.
- ◆ To delete a character to the left of the cursor, press clear. Press and hold clear to delete all characters more quickly

## Text Input Mode

Abc	Multitap Abc (Traditional input mode)
abc	Multitap abc (Traditional input mode)
ABC	Multitap ABC
 Abc	Smart Abc (English Smart mode)
 abc	Smart abc (English Smart mode)
 ABC	Smart ABC (English Smart mode)
123	Numeric
 जजाड़	Smart Hindi
जजाड़	Multitap Hindi (Hindi input mode)



## Calling

### *Making and answering call*



Before you can make or answer any calls, make sure that the phone is charged and your SIM card is inserted before you power on the phone.

Ensure that the phone is on, the network operator name is displayed and the signal strength meter shows network coverage is available in the current area.

#### **To make a call**

- Enter phone number include area code you want to dial. If you key in wrong character, press Clear to delete it.
- Press  (Send key) to call the number.
- Press  (End key) to end the call or to cancel the call attempt.

#### **To make international call**

- Press and hold  key until a "+" sign appears.
- Enter the country code, area code and phone number, and then press  (Send key) to make a call.

#### **To answering call**

- To receive a call, the phone must be switched on and the signal strength meter must be displayed.
- Press  (Answer key) to answer a call.

## Missed Calls

- When an incoming call is not answered, the Missed call log is displayed on your screen. To display the Missed call entry.
- Select the entry and press  (Left soft key) to read call detail.

## To change the ear speaker volume during a call

During a activate call; press Navi key up/down to adjust volume. If the Loudspeaker activate, use Navi key up/down adjust volume also.



## To use loudspeaker during a call

- Loudspeaker mode is uses handset as loudspeaker during a call. Do not hold the handset to your ear if loudspeaker mode on. To activate/deactivate the loudspeaker during a call, press  (Right soft key) H-free/H-held, and the single will show on the screen.
- The loudspeaker is automatically deactivated when you end the call or call attempt or connect the headset to the phone
- The loudspeaker is default setting for playing MP3, voice recorder, using the loudspeaker with MP3 player and Voice recorder, see detail on MP3 player and Voice recorder.

## To call emergency

- Your phone supports the international emergency number, for example, 112 or 911. This number can normally be used to make emergency calls in any country, with or without a SIM card inserted, if a GSM network is within range.
- You can place emergency calls " dial 112 or 911 and press  (Send key) " even if your phone is locked or your account is restricted.

## Tip of call options

A call can be connected to any single caller by pressing  (Left soft key). When user press  (Options) during active call, user can choose one of those functions from the list:

- Hold: Put a call on.
- Retrieve: Reconnect a holding call.
- Retrieve all: Reconnect all holding call.
- Split: To suspend the multi-party call.
- End: End a call.
- New call: Make a new call during an active call.
- Contacts: Shortcut to phonebook menu.
- SMS: Shortcut to Message menu.
- Inbox: Enter to message inbox.
- Sound recorder: Star recorder conversation.
- Mute: Mute the call during the conversation.
- Swap: Switch between the call on hold and active.
- Conference: Make a multi-party conversation.

- Transfer: Transfer a call.
- End single: End one of conference call.
- End all: End a multi-party call.
- DTMF: Set On / Off for DTMF (Dual Tone Multi-Frequency) tone dialing system.

## **Hold a call**

Pressing **⏸** (Options) and selecting **Hold** allows you to put an active call on hold. This feature can be used when an incoming call is received during an active call or if you want to make another without disconnecting the active call.

## **Make a new call during a call**

- You can dial a number during a call without disconnecting the active call.
  - Press (Send key) and selecting **Hold** to put an active call on hold and press Options select **New call** make a new call by keying new number.
  - Press **Options** and select **Swap**, new number will go on hold, and old number will be active.
  - Also, you can select record from phonebook, after select **New call**, press **Back** to option list and choose **Contacts**.

## Multiparty call

- ◆ You can connect to several people together or individually at a time.
  1. Make a call to the first participant.
  2. Call the second participant as explained in **Make a new call during a call**.
  3. Press —/ (Options) and select Conference. This joins the calls to the conference.
  4. Repeat step 2 and 3 to allow new participants to be connected to the Conference.
  5. Press **Options** and select **End all** to end the call. Or press /— (End key).
- ◆ Any call (participant) can be disconnected by press **Options** key and select **End Single**.

## Switch two calls

- ◆ Press —/ (Options) key. The first call is put on hold.
- ◆ To switch between two calls, press **Options** and choose **Swap**.
- ◆ To end the active call press /— (End key). (Or to end both calls at the same time. Press **Options**, and then move to **End all** calls. And press **OK**.)

# Menu Functions & Their Descriptions

## Phonebook (Menu 1)

### Search

You can search contacts by name characters or number.

- ◆ Name and Number, allow you key in the first characters of the name or number for which you are searching in the editor line, the matched record will be shown.
  - ◆ To search the name, users also can put up to 9 characters in the editor line; the matched record will be shown.
  - ◆ To input or edit a searched item, press **Options** key to enter into the submenu.
    - You can **View, Edit, Delete, Copy, Move, Send SMS, Send MMS, Send contact, Add to blacklist, Move to Private** and **Mark** an entry
  - ◆ To view the detail information of the item, press center key.
- \*\* If the contact is moved to the private, you cannot see the detail information in the **Phonebook**, it will be find in the **Extras--Private menu--Phonebook**.

[Note: The default password is 1122]

## Smart Search

You can search contacts by first number of number you key, users can put number search in the editor line, the matched record will be shown, then press Name you send key.

## Add new

◆ It is possible to store phone numbers in three places:

- Add to the **Phone memory**
- Add to the **SIM card**.
- Add to **private**

◆ To store a Number in the **Phone memory**:

In main menu, enter to **Phonebook** menu and select **Add new**. You can store 500 entries in your phone.

- Then select **Add to phone memory**, press **OK**.
- Enter the name and number, press **Done**.
- For each number or text item you can choose:
  - Name / Number / Home number / Company name / Email address / Office number / Fax number / Birthday / \*Image /\*Video call / \*Tone / Caller group

[Note]: Tone support MP3, Midi, AMR, and WAV files.

[Note]: Image support JPEG, GIF format. The JPEG / GIF images size should be less than 200k.

[Note]: Video support motion JPEG files.

When users select Ring tone, Image, Video, you can go to File manager page to choose from every folder. When users use these functions, if there is an incoming call, the Video function will only be performed by Image, the Ring tone will not work. The Video function can be on or off. When the Video sound is off, the Ring tone can be used.

◆ To store a Number in the SIM card:

In main menu, select Phonebook, and select Add new. You can store 250 entries (Maximum) in your SIM card for name, telephone number and image. Then select Add to SIM card, press OK.

- Enter the name, number, caller group and image, press OK.

[Note]: Image support JPEG, GIF format. The JPEG / GIF images size should be less than 200k.

[Note]: The number of store entries in SIM card, it may be different depend on your SIM card service provider

## Move

- ◆ You can move names and phones number from the phone's memory to SIM card's memory or from SIM card's memory to Phone's memory. The copy options have: One by one, All from phone, All from SIM

## Move to private

- ◆ You can move the data from the phone or SIM card to private. The copy options have: **One by one, All from phone, All from SIM**

## Delete

You can remove name and phone numbers from selected contacts all at once.

- In the **Phonebook** Menu, select **Delete** then press **OK**.
- Choose **All from phone memory, All from SIM card** or **One by one** press **OK**. User needs to enter phone code to confirmed delete then press **OK**.

[Note: The default phone code is **1122**.]

## Copy



- ◆ You can copy names and phones number from the phone's memory to SIM card's memory or from SIM card's memory to Phone's memory. The copy options have: **All from phone or All from SIM**.
- ◆ Copy entry records will both save in SIM and Phone's memory.

## Caller groups

- ◆ You can set the phone to sound a specific ring tone and flash a selected graphic on the display when you receive a call from a particular name and phone number. To do this, first include a name and number in a caller group. Then define a ring tone and picture/animation for this group. If you want to activate this function, please store names and phone numbers in the SIM card and phone memory.
- ◆ After entering the Caller group's menu, use Navigation key to select group name. Group default name include: **Friends, Family, VIP, Business and Others.**
- ◆ After selecting the Group name, you can make Group settings to edit **Group name, Group tone, Group image, Group Video call** and **Group member list** for each group. After each setting, press **Done** and **Save**.

## Speed dials

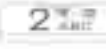
In this function, you can make a call by using the speed dialing keys.

- You can set any of the numbers key  to  to work as a speed-dialing key. To do this you need to assign a contact record to a number key.
- Within **Speed Dials** submenu, select **Status** to **activation** or **deactivation** the function.
- Select **Set number** and select records from contacts then press **OK**.

- After assigning a number to a speed dial key, you can call, reassign the record or undo the speed dial.
- When a phone number is assigned to one of the speed dialing keys (  to  ) you can call the phone number in the following ways:
- If you have set the menu function Speed dials to on, press and hold to corresponding speed dialing key until the call is started.

## Settings

### ◆ My numbers

- You can view and edit personal phone number.  
To display my number on idle screen.

### ◆ Service dial number

- Your service provider may program some special phone numbers into your SIM. It is not possible to modify the Service Dial Numbers.
- The phone number pointed to can only be recalled or dialed.

### ◆ Memory status

- You can check what percentage of the phone's internal memory is occupied and how many name and number entries can still be stored in SIM card's and Phone's memory.

## ◆ **Prefer storage**

- You can choose where you want to save the name and phone number. You can select **Phone memory** and **SIM card**, **Phone memory** or **SIM card**.

## ◆ **Phonebook backup**

- You can backup your phonebook to memory card or restore the phonebook.
- Selected the phone, and the phonebook will be backup or restore to **Images, Audio, Themes, Bluetooth, My music, Photos, Received, Videos and Phonebook** files.
- Selected the card, and the phonebook will be backup or restore to **Images, Videos, Music, Sounds, Other files, Audio, My music, phone and Test** files.

## ◆ **Fields**

- The phone allows you to personalize the contacts looking. In the **Setting** submenu, selected **Fields**, and choose the item you want to display or not.

## ◆ **My vCard**

- You can edit personal vCard in the handset. Also, you can send vCards to your friends that numbers save in the contacts list.
- Edit my vCard

- In the My vCard submenu, select Edit my vCard enter the information for your vCard then select Done.
- Send my vCard
- In the **My vCard** submenu, select **Send contact** and select transfer method: Send by SMS, Send by MMS, Send by Bluetooth and Save to file.

### ◆ **Video Audio**

You can turn the function to **On** or **Off**.

## **Blacklist**

Black list will automatically reject any unwanted call. You can define the list of correspondents you don't want to answer. If this rule is activated and some one from the list is calling, Black list function will automatically decline this call.

- ◆ **Mode:** To turn on/off call black list setting.
- ◆ **Black list:** Edit black list from contacts list or hand input.
- ◆ **Reject log:** To view the reject list

## Messages (Menu 2)

This function only used if your network operator or service provider supports it. Only devices that offer compatible picture message, or multimedia message features can receive and display these messages. Devices that do not have multimedia features may receive details of a link to a web page. In Messages you can create, send receive, view, and edit text message (SMS) / multimedia message (MMS).

### Write new

For detail information is about how to write text in the phone.

- ◆ Select Write new press OK, the create options appear, you can select one of the following options:
- ◆ User can press "#" button to change input method in write message Abc, abc, ABC, SmartAbc, smartabc, SmartABC, 123, Smart Hindi, Hindi.

### SMS

Create and send a text message.

Use navigation key up/down to select message type then press OK. If selected "SMS", the text message editor screen appear.

In the navigation bar, you can see the message length indicator counting backwards from 160. For example, 30 means that you can still add 30 characters for the text to be sent as two messages.

The "SMS" option list includes options for Done, Use template, Insert object and Input method.

The handset supports the sending and receiving of multimedia message that contain several pages (slides). Each slide can contain text, one image and one sound clip.

- ◆ You can add pictures, animations, melodies and sound effects to a text message and format the text using EMS. (Enhanced Messaging Service). In the message press Options key, select Insert object, the object option list appears: Picture, My picture, Animation, My animation, Melody, My melody and Sound.
- ◆ In the message press Options key, select Use template. You can choose templates from the list.
- ◆ To send the message, press Options, select Done and send option appear, choose send option: Send, Save, Send & Save, Send to many, Send to by group and press OK.
  - If users select Send, you should enter the Phone number by yourself or search the contacts by pressing LSK, which is Quick Search (in this page, users can put up to 9 characters to sorting the desired names.) and press OK to send the message.
  - If users select Save, you can choose Save to normal and Save to private.
    - Save to normal: the sent message is stored in the Messages---Drafts folder.
    - Save to private: the sent message is stored in the Organizer---Private menu---Messages---Drafts.

- \* If the message is stored in Private, users need to enter the password to view the detail information of the message.

[Note: The default password is 1122.]

## **MMS**

Create and send a multimedia message.



Use navigation key up/down to select message type then press OK. If select "MMS", the MMS editor screen appear.

- ◆ Use navigation key to select recipients from the contacts directory, or write the phone number or email address of the recipient in the To field if you are sending a MMS or email to the recipient. You also can edit the phone number or email address of the recipient in the CC and BCC fields if you are sending a MMS or email to the recipient.
- ◆ To edit the subject of the MMS or email, scroll to Subject field.
- ◆ Scroll to Edit content, press Edit enter Edit slide text. Press Options, you can select: Done, Input method, Add image, Add audio, Add video and Add attachment, Add slide before, Add slide after, Delete slide, Next slide, Preview, Slide timing.
- ◆ To insert a file in the message, scroll to Add attachment option then press OK. Press Open to link a specific folder in File manager and scroll to the desired file, then press OK and Done. An attached file is indicated with the file name in the message.

- ◆ To send the message, press Done and send option appear, choose send option: Send only, Send and save, Save to drafts, Send options, Exit and press OK.
  - If users select Send and save/Save to drafts, the sent message is stored in the Messages---Drafts folder.

## Inbox

- To check an unread message later:
  - ◆ From **Messages** menu selects **Inbox** press **OK**.
  - ◆ Move to desired message and press **OK** to enter list. Press **Options** and inbox option list appears, you can select **Detail, View, Delete, Delete all, \*\*Move to private and Mark**. The message is stored in the inbox folder after you have read it.

	The icon is indicate whether a SMS is read or unread and also show message stored position in front of the message in the list.
	The icon indicates whether a SMS is illegal message format or broken message, which cannot be displayed in the Message body screen.
	The icon is indicating whether a message is read or unread in front of the message in the list.

- ◆ While reading the message, press Options to select through the list of options and press OK at the highlighted option to select it.
- ◆ The inbox message option list includes options have Reply, Delete, Dial, Edit, Forward, Chat, Advance (Copy / Move / Copy all / Move all), Use number, Extract URL, Save objects and Move to private.

## Drafts

- ◆ To finish or view an draft message
- ◆ From Message submenu select Drafts move to desired message and press Options, the options list appears you can select Detail, View, Delete, Delete all \*\*Move to private and mark.
- ◆ While reading the message, press Options to select through the list of options and press OK at the highlighted option to select it.
- ◆ The Drafts message option list includes options have Send, Edit, Delete, Use number, Extract URL, Move to private.

## Outbox



- ◆ In Idle mode enter Menu, Messages and outbox than Press OK.
  - ◆ Move to desired message and press OK to enter list. Press Options and inbox option list appears, you can select Detail, View, Delete, Delete all, Move to private and mark.
  - ◆ While reading the message, press Options to select through the list of options and press OK at the highlighted option to select it.
  - ◆ The outbox message option list includes options have Send, Delete, Edit, Copy, Move, Use number, Extract URL and Move to private.
- \*\* If the SMS is moved to the private, you can not see the detail information in the Messages---Inbox/Drafts/outbox folder, it will be find in the Extra --- Private menu --- Messages --- Inbox / Drafts / outbox folder.

## Delete folder

You can choose delete process depend on that selection message box or once deleted all folder messages

## Templates

- ◆ Select Templates press OK, the templates options appear, you can select one of the following options: SMS / MMS.
- ◆ From the SMS templates list, press Options key to Edit, SMS or Erase template message.

- ◆ From the MMS templates list, press Options key to View, Detail and Create MMS.
- ◆ When have an incoming call, you can press  (RSK) mute the ring tone and press  (RSK) SMS again enter the templates list to send a text message.

## Message settings

Message setting have been divided into groups according to the different message types. Select the settings you want to edit, and press OK key.

### ◆ SMS

- Profile setting: lists all the message centers that have been defined.
- Common settings: The message settings under the SMS menu are common to all outgoing SMS, irrespective of the selected set.
  - Delivery report
  - User can turn On or Off this function if user wants to receive delivery report from service provider or not.
  - Reply path
  - Also, user can choose to use the same service center as the received message to reply or not.
- Prefer storage
  - You can choose where you want to save the message depend on memory status.

- If either one of storage locations, SIM card or Phone, already full, the phone will automatically save information to another.
- Select Phone memory or SIM card and press OK.
  - Prefer bearer
- The Prefer bearer settings to set the settings for selected bearer.
- The Pref. bearer list are:
  - Prefer GPRS
  - Prefer GSM
  - GSM only

◆ MMS

- Within the Setting submenu of the Message setting you can change the settings of a Multimedia message sending option:
- Sending:

<p><b>Validity period</b></p>	<p>This is the duration that your message is stored at the Message center. Delivery attempts will be repeated until the message has been delivered or expired. The options of length of time have: Max. / 1 hour/ /12 hours/1 day/1 week.</p>
<p><b>Delivery report</b></p>	<p>User can turn On or Off this function if user wants to receive delivery report from service provider or not.</p>

<b>Read report</b>	User can turn On or Off this function if user wants to receive report from service provider or not.
<b>Priority</b>	User can choose message priority; the options have: Normal, High, and Low.
<b>Slide timing</b>	User can set slide timing by own desire.
<b>Delivery time</b>	The option of length of time has: Immediate/ In one hour/In 12 hours/In 24 hours.

➤ Retrieve:

<b>Home network</b>	The options of home network have: Immediate / Restricted / Delayed.
<b>Roaming</b>	The options of roaming network have: As home / Delayed / Restricted.
<b>Read report</b>	The options of read report have: On request / Send / Never send.
<b>Delivery repor</b>	User can turn On or Off this function to ask the network to send delivery reports about your message.

➤ Filters:

<b>Anonymous</b>	The option of anonymous have: Allow/ Reject.
<b>Max size (KB)</b>	Set multimedia messages size by user.
<b>Advertisement</b>	The option of advertisement setting has: Allow/ Reject.

➤ Edit profile:

You may use network or service provider to receive and send multimedia message.

## Memory status

- ◆ You can check what percentage of the phone's internal memory is occupied and how many messages can still be stored in SIM card's or Phone's memory.
- ◆ The phone will show message to remind user if SIM card and Phone set both out of memory.

## Chat

Chat is a way of sending short, simple text message. You send your message to different person in the same time via chat room 1&2.

- ◆ Starting a chat message
  - Enter the Chat menu, select Chat room from the list
  - Press Options enter chat room submenu, you can see

- Chat room info
  - Press Edit to edit the nickname that you want to use during chatting.
  - Scroll to Remote number, press Edit to edit the number that you want to chat with.
  - Press Done when confirm save message show up.
  - Start new
  - Go to Start new and press OK to write chat message.

## Voice messages

◆ Voice messages are a network service and you may need to subscribe to it first. For more information and for the voice mail number, contact your service provider. Press Menu, and select Messages, and Voice messages.

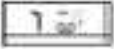
- Each phone line may have its own voice mailbox number.
- Within Voice messages submenu, choose phone line 1 or 2.
  - The option are:
    - Edit: general number editor.
    - Erase: erase the voice mail number.
    - Dial to listen: user can dial the voice mail server number to listen voice mails.
    - Choose the option and press OK to save it.
    - In the Idle mode, holding and pressing  can connect to voice mail.

## Broadcast message

Broadcast message are spread by the network service to all handsets in a cell. User cans enable/disable the service to choose if user wants to receive broadcast messages from particular channels or not.

- Info service  
When you turn on/off the mode, you can choose to receive or not receive the last broadcast message received.
- Topics  
Using the direction of Navigation key allows you browse through the message. Press OK or Back, if you want to read or exit.
- Languages  
User can select the languages of the Info Messages user wants to receive.
- Channel settings
  - You can select the channels from the channel list.
  - You can add new channels where you want the messages to be received to the list. Then select it from select list.
  - Also, the function allows you Select, Add, Edit, and Delete setting.

The numbers of the last 150 (Each page of Missed calls / Dialed calls/ Received calls can save 50 calls) calls that you have made are saved in the call history list. If your subscription includes the Calling Line Identification service and the caller's number is identified, the call history list also shows the numbers of received and missed calls. Miss calls, Dialed calls and Received calls are list under separate tabs. User can press  (Send key) enter call list from idle mode. Use navigation key to scroll between the tabs.

### **Call records**

- From idle mode, press  (Send key). Scroll to the **Call records** press **OK**. Within the submenu, you can view all the Missed, Dialed, and Received calls.
- In the list of **Call records** press **OK** display Call information.
- In the Call logs list, press **Options**, you can: Delete / Save / Dial / Edit / Send SMS / Send MMS / Add to blacklist / Delete all / Move to private / Mark.

## **Missed calls**

- From idle mode, press  (Send key). Scroll to the **Missed calls** press **OK**. Within the submenu, you can view the phone numbers from which somebody has most recently tried to call you
- In the list of missed calls press **OK** display Call information.
- In the missed calls list, press **Options**, you can: Delete / Save / Dial / Edit / Send SMS / Send MMS / Add to blacklist / Delete all / Move to private / Mark.

Users also can press **Menu**, select **Call history** press **OK** to see all the **Missed calls**, **Dialed calls** and **Received calls** information in this submenu.

\* Users only can see **Call logs** information by pressing  (Send key) from idle mode.

\*\* If the call record is moved to the private, you can not see the detail information in the **Call history---Missed calls / Dialed calls / Received calls** folder, it will be find in the **Extra---Private Menu---Call record---Missed calls / Dialed calls / Received calls** folder.

**Note:** The default password is 1122

Within the Call record submenu, we also have many other functions:

## **Dialed calls**

- From idle mode, press  (Send key). Scroll to the **Dialed calls** press **OK**. Within the submenu you can view the numbers from which you have most recently called or attempted calls.
- In the list of dialed calls press **OK** display Call information.
- In the dialed calls list, press **Options**, you can: Delete / Save / Dial / Edit / Send SMS / Send MMS / Add to blacklist / Delete all / Move to private.

## **Received calls**

- From idle mode, press  (Send key). Scroll to the **Received calls** press **OK**. Within the submenu you can view the numbers from which you have most recently accepted calls
- In the list of missed calls press **OK** display Call information.
- In the received calls list, press **Options**, you can: Delete / Save / Dial / Edit / Send SMS / Send MMS / Add to blacklist / Delete all / Move to private / Mark.

## **Delete**

- In this submenu, Press **OK** display
  - Missed calls
  - Dialed calls
  - Received calls
  - Delete All
- Press **OK** to delete it

## **Call duration**

- This function records the length of time or duration of all incoming and outgoing calls in hours, minutes, and seconds.
  - **Last call time:** Display last one outgoing call in hours, minutes, and seconds.
  - **Total dialed:** Display the time for all outgoing calls in hours, minutes, and seconds.
  - **Total received:** Display the time for all incoming calls in hours, minutes, and seconds.
  - **All Call Time:** Display the time for all outgoing and incoming calls in hours, minutes, and seconds.
  - **Reset all time:** Clear the time records.

## **Call cost**

- This network service allows you to check the cost of your last call or all calls. The call costs are shown separately for each SIM card.
  - **Last call cost:** you can set the phone to show the cost of last call. You may need the PIN2 code to select the currency or unit. Contact your service provider for charging unit prices.
  - **Total cost:** you can set the phone to show the remaining talk time in terms of charging units or units of currency by using this option. You may need the PIN2 code to select the currency or unit. Contact your service provider for charging unit prices.

- **Max cost set:** you can limit the costs of your calls to a certain amount of charging units or units of currency by using this option. You can make and receive charged calls as long as the specified cost limit is not exceeded. The number of remaining units is shown in the idle mode. You may need the PIN2 code to set the **Max cost**.
- **Reset cost:** this option allows you to reset the call cost counter. You may need the PIN2 code to clear your setting.
- **Price per unit:** this is the cost that the Service Provider charges for one unit of call time. At this point you will be asked to enter your PIN 2 code to set this function.

### ***SMS counter***

This function can show you how many SMS you already sent and received.

### ***GPRS counter***

With the GPRS counter you can check the amount of data sent and received data in last session in total and to clear the counters. The counters unit is a byte. To reset counter, answer "Yes" when confirm



## Settings (Menu 4)

### Display settings

#### ◆ **Wallpaper**

- You can set your phone to display a background picture, wallpaper, when the phone is in idle mode. You can also download wallpaper from WAP and MMS and then save them in My folder under File manager. Your phone supports JPEG, GIF formats.

[NOTE]: The wallpaper and screen saver should be less than 1280x1024 (for JPG) and 320x240(for GIF). In addition, the file size can't be over 300kb.

[NOTE]: If image size is over size, the image displays speed might get slow and please wait for more time to show up.

- To select a wallpaper picture
  - Press **Menu**, and select **Settings, Display Settings** and **Wallpaper**.
  - Select **Default** and image list will be shown. Use navigation key left and right direction to select the image and press **OK** to choose the desired picture then press **OK**.

- To set own picture for wallpaper. To select **My folder** and press **OK**. Users can select wallpaper from **Images/ Photos** and **Phone** folders. Scroll to desired folder and press **Open**. Use navigation key ▲ and down ▼ direction to select the image or photo and press **OK**.

## ◆ **Screen saver**

- The screen saver is activated when the phone is in idle mode and none of the phone's function been used for a certain time. Press any key to deactivate the screen saver.
- Turn Settings on to activate the screen saver.
- With **Select**, you can choose an image or animation as screen saver from the **Default** list.
- Select in timeout after which time the screen saver will be activated.
- To set own picture for Screen Saver, with **Select**, choose **From Gallery**.
- Users can select screen saver from **Images, Photos, Video, Phone** and **Card** folders. Scroll to desired folder and press **Open**.
- Use Navigation key up ▲ and down ▼ direction to select the image and press **OK** to select.

- Use Navigation key up ▲ and down ▼ direction to select the image and press OK to select.

### ◆ **Standby mode settings**

- Date and time  
You can turn this function on or off to show or hide Date and Time.
- Own number  
You can turn the function on or off to display or hide own number.
- Network name  
You can turn the function on or off to display or hide your service provider name in idle screen.

### ◆ **LCD backlight**

- LCD backlight  
To set the LCD backlight.
- Keypad backlight  
You can turn this function on or off.

### ◆ **Font setting**

- Font size  
This function allows you to change the size of the font displayed in SMS, Phonebook, Time or Date. The options are: Small font / Normal font / Large font.

[Note: Font size setting only for SIM and Phone book.]

### ➤ Font color

This function allows you to change the color of the font displayed in Menu, SMS, Phonebook, Time and Date. The options are: Theme color/ Black/Blue/ Brown/ Dark Blue/ Gary/ Green/ yellow/ Pink/ Red/ White/ Dial number color

This function allows you to change the color of the font displayed in Dial number. The options are: Theme color/ Black/ Blue/ Brown/ Dark Blue/ Gary/ Green/ yellow/ Pink/ Red/ White/

## Date & time

### ◆ ***Set the time***

This function allows you to set the time. The format is <HH:MM>.

### ◆ ***Time format***

This function allows you select the format of the time display, 12 or 24. Use navigation key to change it and press **OK**.

[Note]: The time and date format display is depending on user settings.

◆ **Set the date**

This function allows you to set the date.

◆ **Date format**

This function allows you select format of the date display, use navigation key to change it press OK.

◆ **Auto-update of date / time**

- Within Settings menu, select Auto- update of date / time (network service) to set the phone to automatically update the time and date according to the current time zone, select On.
- Automatic update of date and time does not change the time you have set for the alarm clock, calendar or the alarm notes. They are in local time. Updating may cause some alarms you have set to expire.

## Phone settings

◆ **Language**

This allows you to switch between different languages and to select a language for the display texts.

## ◆ **Welcome note**

- You can turn the function on or off to display or not display the “Welcome note, when you switch on the phone.
- If you turn the function on, you can edit the Note.

## ◆ **Preferred input methods**

This allows you to set the preferred input method.

## ◆ **Navigator key**

- You can edit some specific functions to the navigation key for your personal hot key and activate them.
- Within Up, Down, Left, and Right, and short cut options list, select desired shortcut from the function list.
- Users can select every menu for shortcut menu, but we have set 46 standard menus in shortcut.

## ◆ **Flight mode**

- You can switch you phone to flight mode when you take aircraft. The options of flight mode are: Normal mode, Flight mode and Query when power on.



## Call settings

### ◆ **Caller ID**

In the call setup menu, the Caller ID allows you to check the status of whether a caller's identification is sent.

- In the submenu, you can choose **Set by network**, **No** or **Yes**.
- When you choose **Set by network**, your phone must be registered with a network

### ◆ **Call waiting**

- This network service allows you to answer an incoming call while you have a call in progress if you have activated the menu function
- In the submenu, select **Activate** and press OK to switch on function. It way, selects **Deactivate** to switch off the function.
- You can check function status while you select **Check status**.

### ◆ **Call divert**

This network service allows you to redirect incoming calls from you phone.

- **Divert all voice calls**  
All voice calls are diverted and no ringing tone is played at an incoming call.
- **Divert if out of reach**  
Voice calls are diverted when your phone is switched off or outside of the network service area.
- **Divert if not answered**  
Voice calls are diverted when you don't answer a call within the present timeout.
- **Divert if busy**  
Voice calls are diverted when your number is busy. If divert If busy is activated, rejecting an incoming call will also divert the call.
- **Divert all data calls**  
All data calls are diverted.
- **Cancel all diverts**  
In the submenu, select **Cancel all divert**. Press **OK** to cancel all diverts

## ◆ **Call barring**

This network service allows you to restrict incoming calls to and outgoing calls from your phone. A barring password is required for using the function.

- **Outgoing calls**  
To barring all Outgoing calls.

- International calls  
To barring Outgoing international call.
- Int. calls except to home country  
To barring Outgoing international call expect home country.
- Incoming calls  
To barring all Incoming calls.
- Incoming calls when roaming  
To barring all Incoming calls when roaming.
- Cancel all barrings
  - This function is cancel all call barring.
  - This service may sometimes not be supported by your network. Also, a network code is required to access this service.
- Change bar code  
To set barring call, you are asked to input your barring call password. This menu enables you to change your barring call password. To know the default password setting, please contact your service operator.

## ◆ **Line Switch**

- Line for outgoing calls is a network service to select phone line 1 or 2 that is subscriber number for making calls, within call setup submenu, select **Line Switch**, and choose Line1 or 2.

- If you select Line2 and have not subscribed to this networks service, you will not be able to make call. However, calls on both lines can be answered regardless of the selected line.

### ◆ **Call time reminder**

Turn function On/Off to remind duration of a call. When this option is set to On, there will be a short beep when duration of a call exceeds the reminder time.

### ◆ **Call time display**

Turn function On/Off to show calling time.

### ◆ **Auto redial**

Select On and your phone will make a maximum of ten attempts to connect the call after an unsuccessful call attempt.

### ◆ **Closed user group**

This is a network service that specifies the group of people whom you can call and who can call you. For more information place contact your network operator or service provider.

## Connection setting

### ◆ **Bluetooth**

You can utilize wireless technology of Bluetooth to connect other inclusive devices. The inclusive device may include the mobile phone, the computer and earphone, etc. You can utilize Bluetooth technology transfer image, the film, music and sound file.

[NOTE]: After opening the Bluetooth function, will increase the power consumption of the battery.

- **Power**  
Turn on or off the Bluetooth function. After turn on the Bluetooth function, will reveal  in top screen.
- **Inquiry audio device**  
Search the new Bluetooth device in the range and pair it. Before pairing, please set up the password, and reach an agreement to use the same password with another device user.
- **My device**  
Pair the old Bluetooth device.
- **Active device**  
To Active the Bluetooth device that has.
- **Settings**

- **Visibility:** Whether setting up your mobile phone should let the other Bluetooth device be found.
- **Change device name:** Change your mobile telephone name (the display among other Bluetooth apparatuses).
- **Authentication:** Turn on / off the Authentication function.
- **Audio path:** Whether choose from mobile phone answering a call directly or forward to BT headset.
- **FTP settings:** File transfer protocol setting.

➤ **About**

Your Bluetooth mobile phone device explains.

[Note] : The file transfer via bluetooth will be saved in received folder.

## **Network Settings**

The function allows you to set network related settings.

➤ **Network selection**

- The phone automatically selects one of the cellular networks available in you area, when auto mode is selected.
- In manual mode the phone will show a list of available networks that you can choose from. Only networks that have a roaming agreement with your home network operator are allow to be selected.

- **Prefer networks**  
The network list is used when the mode is set to automatic. The order of the prefer network list indicates the search priority. Press Options key to edit prefer networks: **"Add from list"**, **"Create new"**, **"Change priority"** and **"Delete"**.
- **Band selection**  
The wireless phone described in this guide is approved for use on 900MHz, 1800MHz, 1900MHz and Auto networks. You can choose the band from the list.
- **GPRS connection**  
**"Always online"** and **"When needed"** options are available for the GPRS connection status.

## Security Settings

### ◆ **Pin lock**

- This function allows you to lock the phone with a specific SIM card. The feature is designed to prevent the use of your phone by means of another person's SIM cards if your phone becomes lost.

- You can switch on or off to activate the PIN lock function. If you switch PIN Lock on, every time you turn phone on, you need to enter the PIN number to set the request on.

[Note]: the default password is 1122.

### ◆ **Phone lock**

You can switch **When switch on / Off** the Phone lock function to protect your phone. If you select **When switch on**, you need enter the password to set the request on.

### ◆ **Auto keypad lock**

- This allows you to lock the phone's keypad to prevent accidental key presses.
- In submenu, select the time that after the last key press will be disabled, then press OK.

### ◆ **Fixed dialing**

- You can switch mode on and off.
- This function dials only the numbers in the fixed dialing number (FDN). To save and edit numbers on the list, you need the PIN2 code.

### ◆ **Barred dialing**

You can switch mode on and off.

### ◆ **Change PIN code**

- Change PIN code  
This allows you to change the PIN number.
- Change PIN2 code  
This allows you to change the PIN2 number.
- Change security code  
This allows you to change the password.

## **Restore Factory Default Settings**

- ◆ Within this menu you can reset the menu settings to their original values. The security code is needed for this function.

[Note]: the default password is 1122.

- ◆ After you select restore factory, setting values are returned default value. Those value including Profile, Ring tone, Call log, Caller group, Time format, Wallpaper, Screen saver, Themes, WAP setting etc.

## Fun Spice (Menu 5)

You can access various mobile Internet services with your phone browser. Please remember always use only services that you trust and that offer adequate security and protection against harmful software.

Check the availability of these services, pricing, tariffs, and instructions with your service provider. With the phone browser you can view the services that use wireless markup language or extensible hypertext markup language on their pages. Appearance may vary due to screen size you may not be able to view all details of the Internet pages.

### SpiceGang

**SpiceGang** is a WAP portal from where user can download Ring tones, Wallpapers, Animations, Videos and other kind of content.

**Step1:** Check the GPRS settings for your operator

**Step2:** Initiate SpiceGang WAP portal to browse and download the content

**Step3:** Charges for download apply as per operator pricing

Explore the whole world of Entertainment with SpiceGang.





## **Ibibo**

**Make New Friends** – <http://mspicegang.ibibo.com/>

**Cool Stuff** – <http://mspicefree.ibibo.com/>

**Cricket Updates** – <http://mspicefree.ibibo.com/mcricket/index.php>

**Free SMS** - <http://mspicefree.ibibo.com/freesms/sms.php>

## **NgPay**

Java application is provided by **Spice**.

## **Opera Mini**

Java application is provided by **Spice**.

## **Nimbuzz**

Java application is provided by **Spice**.

## **Reuters**

Reuters India gives you the latest India, World and Business news and more. Also, get the latest stock market information along with tools like the currency converter and weather in your city on your mobile phone.

Please ensure that you have GPRS settings in your phone to open Reuters. Contact your operator for GPRS settings.

## **MGurujee**

**Sample Papers** – <http://wap.mgurujee.com>

**Education Search** – <http://wap.ibibo.com/medu/index.php>

**Job Search** – <http://wap.ibibo.com/mjobs/index.php>

**Calculator** - Clicking on this icon will open the inbuilt Calculator of the phone.

## **Voice Zone**

**Sangeet** – Spice Mobiles presents Sangeet Portal – One Touch Access to the huge library of songs comprising of 17 languages and over 1 lakh tracks!

**Bhakti Sangeet** – Spice Mobiles present Bhakti Sangeet on IVR. Use this portal to listen to your favorite devotional songs at the click of a button, virtually, anytime and from anywhere.

**SUNO SUNAO** - Spice Mobiles brings SUNO SUNAO to its customers. It gives the anonymity, thrill, excitement and above that a chance to speak and listen to the Chat friend!



## ContactsBackup

Java application is provided by Spice.

## Game

- ◆ Your phone software includes some games specially designed for this handset.
- ◆ You can launch a game by press **Menu/Multimedia** and select **Games**.
- ◆ Use Navigation key select a game or game set, press **OK**.
- ◆ Press **OK** again, you can choose the option that you want:
  - Resume
  - Start game
  - Game level
  - Best grades
  - Game help
- ◆ Game setting
 

This function designs for **Games** only.

  - BGM: Turn On / Off music.
  - Sound effect: Turn On / Off effect of game.
  - Game vibration: Turn On / Off vibration of game.

## AfterSpice

**AfterSpice** is a chain of Spice Service Stations to deliver complete customer satisfaction.

# Utilities

**Email2SMS** - Email2SMS is a product of Netcore Solutions Pvt. Ltd. provided by Spice Mobiles.

Email2SMS allows you to receive email on your phone via SMS without GPRS. You can Read, Reply, Compose and Forward your emails via SMS. This service is only available for Gmail, Indiatimes and Corporate Account Holders. Please visit [www.m3m.in/tnc.html](http://www.m3m.in/tnc.html) to view detailed terms and conditions. By using this service, you agree to all terms and conditions mentioned on the above-mentioned URL.

**Private Menu** - You can move the Call records, Messages, Phonebook and File manager to the Private Menu, if you do not want others see this detail information.

[Note]: To enter the submenu of the **Private Menu**, users need to enter the password. The default password is 1122.

**MTracker** – Cell phone safety features and applications continue to advance in the face a rapidly changing security and theft threats. The latest of these advances is Mobile Tracker, which ingeniously traces your lost or stolen handset, significantly improving your chances of recovery. When a SIM is removed and replaced, a discreet SMS (with your IMEI and the unauthorized User's number) is sent to one or two pre-set numbers.

**Step1** - Go to **Fun Spice** > Utilities to find Mobile Tracker

**Step2** - Select **MTracker** and press OK.

**Step3** - It will ask for password. Please enter password and enter Mobile Tracker

**Step4** - You will see two options - **Mode** and **Mobile Number**

**Step5** - Change the Mode to **ON** and enter the mobile number to which you would like to receive the message in case you loose it. Press **Save** and come out

**Step6** – That's it. Now whenever a new SIM card is inserted in your Spice phone you will receive the following message from the NEW SIM CARD NUMBER - Dear Spice Mobile Customer; your mobile is used by the IMEI No. XXXXXXXXXXXXXXXX. In case your mobile is lost or stolen please inform the concerned authorities about this

**Panic Button** –Spice Mobile offers Panic Button to its customers! Using this application you can send a pre defined message to up to 5 pre defined mobile numbers. Whenever you are in a panic situation or you feel uneasy just press the panic key and inform your loved ones!

**Step1 - Mode** - Switch on mode of the application

**Step2 - Message** - Enter the message that you want to go at the press of the panic button. Panic Button is key 5 in idle mode

**Step3 - Number List** - Enter up to 5 mobile numbers to which panic message will go at the press of the panic button

**Step4** – That's it. You are done! Now whenever you feel uneasy just long press 5 key and the pre defined message will go to pre defined numbers.



## File Manager (Menu 6)

In the **File manager** menu, you can manage images, photos, recordings, tones that you have.

- ◆ Press **Menu**, select **File manager**, press **OK** to enter submenu of **File manager**.
  - In the **File manager** screen, a list of folders is shown.
  - Scroll to the desired device **Phone Card** press **Options**, you can choose **Open**, **Create folder**, **Memory status** and **Format** item. One of the options is available.

<b>Open:</b>	To view the files in the folder. The files in this folder have: Audio, Bluetooth, Images, My Music, Photos, Received and Video. For selected folder, press "Options", one of the options is available: Open, Create folder, Rename, Delete, Sort and Move to privacy
<b>Create folder:</b>	To add a new folder into list.
<b>Memory status:</b>	You can check what percentage of the phone's internal memory is occupied and how many files can still be stored in Phone's memory and memory card.
<b>Format:</b>	You can format the file list.

Remove	Let's you SD card data change to empty after choose delete This SD card will without any data
--------	---

- Scroll to the desired file, and press **Options** select options, the file option have: View (Image), **Play** (Video, Audio), **Set as** (Set as Ringtone, Set as Message Tone), **Send** (MMS, Bluetooth), **Detail**, \ **Rename**, **Copy**, **Move**, **delete**, **Delete all**, **Sort**, **Move to private** and **Mark**.

## Shortcuts (Menu 7 )

- The Shortcuts screen displays 10 favorites items set by the user.
- You can edit some specific functions to the default list for your personal favorites list and activate them.
- Within Favorites menu, tick the box from the function list
- The phone offers you an extensive range of functions, which are grouped in menus and submenus. From idle mode, press Navigation key can access the shortcuts menus.

## Camera

**[Note]:** Please obey all local laws governing the taking of picture.

Your phone has a digital camera and digital video recorder. You can take pictures, record video clips, view them and send them in MMS. To do this, you must subscribe to these services. Please check with your network operator. The camera lens is on the back of the handset and the display of the handset works as viewfinder. The camera produces pictures in JPEG format and the video clips in motion JPEG format. Please pay attention; if handset is not enough memory to take a new photo, you need to free some by deleting old photos or other files in the **File manager**.

To access this menu, press **Media center** and select **Camera**.

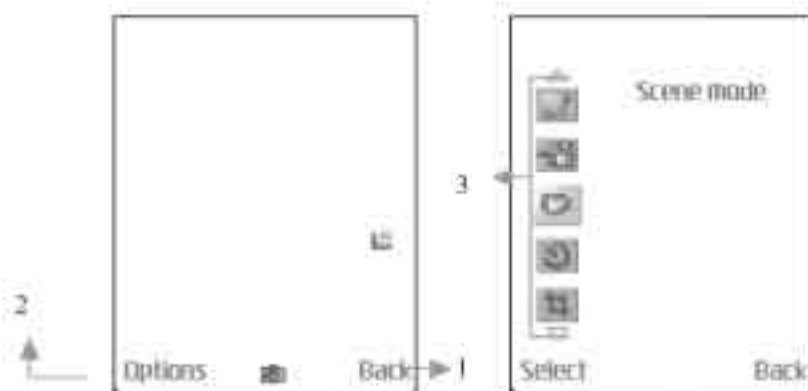

1. Press "Back" to go back previous level.
2. To select option displayed in the areas, press the Options to choose camera options.
3. Camera's options menu.
4. Area used for displaying functions icon, such as image size.

◆ **Taking a Photo**

- The live image appears on the display, and you can use the display as a viewfinder.
- To take a photo press center key  to capture. When taking a photo a shutter sound is heard. The phone saves the photo in the **Photo album** of the **Media center** menu.

◆ **To setup camera option**

Press **Options** enter options bar. User can select:

- **Capture mode:** Take a photo in the following mode.
  - **Single:** Take a photo in the normal mode.

[Note]: When user set camera capture mode to "Single", and then all camera options available except "Mode setting".

- **Sticker:** Take a photo with frame.

[Note]: To switch photo frame, by pressing the corresponding number key ,

- **Burst shot:** Take a series of photos.

[Note]: To switch/adjust camera Burst shot setting, by pressing the corresponding number

- **(Mode setting):** The option might change depend on Capture mode, for detail see table below.
- **Save mode:** There are Manual Save and Auto Save that you can choose.
- **Scene mode:** This mode provides the best scene position setting for the scene being shot, for detail see table below.

[Note]: To switch/adjust camera Scene mode setting, by pressing the corresponding number

- **Self timer:** Set a time delay before the camera takes a photo, the detail option see below table.

[Note]: To switch/adjust camera Self-timer setting, by pressing the corresponding number key .

- **Image size:** Select an image size, for detail see table below.

[Note]: To switch/adjust camera Image size setting, by pressing the corresponding number key  .

- **Image quality:** To define how much the photo file will be compressed when saving the image, the detail option see below table.

[Note]: To switch/adjust camera Image quality setting, by pressing the corresponding number key  .



- **Effect settings:** Apply a special effect to the photo, the detail option see below table.

[Note]: To switch/adjust camera effect setting, by pressing the corresponding number key  .

- **Shutter sound:** Select the sound that you hear when you take photo.
- **EV:** Select the value of EV to the photo, for detail see table below.
- **AE meter:** This determines the exposure by metering and calculating the light levels in the center and other areas of the image separately.
- **Banding:** Adjust screen backlight flicker, the detail option see below table.

- **White balance:** Adjust the color balance of the photo, the detail option see below table.

[Note]: To switch/adjust camera White balance setting, by pressing the corresponding number key  .

- **Storage:** Select storage place in phone or memory card.
- **Restore default:** Restore camera setting to default.
- To turn on/off the option icon displayed on the screen, by pressing the corresponding number key  .
- To switch between camera/video recorder mode, by pressing the corresponding number key  .



<b>Camera options</b>	
Capture mode	Single / Sticker / Burst
Mode setting	<ol style="list-style-type: none"> <li>1. If capture mode set to Burst shot, the mode setting have options are: 4 shots / 6 shots</li> <li>2. If capture mode set to Sticker shot, the mode setting have options are: Frame 1 / Frame 2 / Frame 3</li> <li>3. If capture mode set to single shot, the mode setting will be disabling.</li> </ol>
Save Mode	Take and save / Automatic save
Scene mode	Auto / Night
Self timer	Off / 5 sec / 10 sec / 15 sec Off / 5 sec / 10 sec / 15 sec
Image size	160*120 / 176*220 / 320*240 / 640*480
Image quality	Low / Normal / High / Fine
Effect settings	Normal / Gray scale / Sepia / Sepia green / Sepia blue / Color invert
Shutter sound	Off / Sound 1 / Sound 2 / Sound 3
EV	EV+1 ~ EV+4 / EV0 / EV-1 ~ EV-4
AE meter	Auto / Spot / Weight / Average
Banding	50 Hz / 60 Hz
White Balance	Auto / Daylight / Tungsten / Fluorescent / Cloudy / Incandescence

Storage	Phone / Memory card
Restore default	Restore camera setting to default

## Media Player

Your phone includes a Music player for listening to music tracks. MP3 files stored in the Audio folder (Default setting) will automatically be detected and added to the default play list. You can listen to the sound files via a compatible headset, or the phone's loudspeaker. You can make or answer a call while using the music player. During a call, the playback is paused.





**[Note]:** Because of the small dimension of the speaker, in some cases the audio could be distorted, especially at maximum volume and when there are lots of bass sounds. Therefore, we recommend you to use the stereo headset in order to appreciate the high quality of your music.

The Music Player supports: AAC, AAC+, MP3, AMR, WAV, MIDI, iMelody formats.

### ◆ **Playing the audio**

- User can listen to music on the loudspeakers or with headphones.

- MP3 headphones jack: Only for playing MP3 file. It provides the other user can also listen to the music or sound from MP3 file by his headphones.
- Use the functions of the four ways Navigation key as describe in the bellow table:

	Four Ways Navigation key	Start/pause
	Up	increase volume
	Down	decrease volume
	Left	<p>⏮ Short press to skip previous tracks</p> <p>Long press to jump previous segment</p>
	Right	<p>⏭ Short press to skip next tracks</p> <p>Long press to jump next segment</p>

◆ In the **Music player** menu, pressing **List** allows access to the following settings.

➤ **List**

You can view all the tracks available on the track list and play the desired track. If you press **Options** in the Play list, you can:

- **Play:** To play selected music.
- **Add:** To add music, which not store in the MP3 folder.
- **Delete:** To delete the selecting music.
- **Rename:** To modify the name of the selecting music.
- **Add to ring tone:** To add selected music for ring tone.
- **Detail:** To show music information
- **Delete all:** To delete all the music in the play list.

## ➤ **Settings**

Music player's setting options.

- **Storage:** Storage place in Phone and memory card.
- **List auto generate:** Turn On/Off for **List auto generate**.
  - ◆ When List auto generate function turns on, user can refresh the track list (for example after adding new tracks to the list) and change the track list that is shown.

◆ When List auto generate functions turns off, user can add tracks from the different folder in File manager.

- **Skin:** To change the skin. The function include: Skin 1 ~ Skin 3.
- **Repeat:** To play the current track or the enter track list repeatedly.
- **Shuffle:** Turn On/Off Shuffle function.
- **Background play:** Turn On/Off Background plays function.
- **On:** Allow music continuing playing when left music player.
- **Off:** When user left music player, music will stop.
- **Equalizer:** To change the equalizer. The function include: Normal, Bass, Dance, Classical, and Treble, Party, Pop, and Rock.

[Note]: All music tracks must be storage in My Music (Default setting, user may not be change path.)

- Add / Delete Music to play list
- ◆ Please turn off the handset before Add/Delete music.

- ◆ Plug in cable (USB) to handset and PC, screen show three options:
  - Mass storage mode: For add / remove music or image.  
In the Mass Storage mode, user can add / remove music to handset via PC.
  - COM port: as USB charger.

[Note]: When you plug in USB cable, can select Mass storage, the handset will remain power on status. The handset will automatically connect to memory card only. If you want connect to the phone, please power off the handset

## Video player

**Video player** is a folder under **Media center**, the folder name **Video player**. It is a folder to save the video. You can view video in this folder.



Press **Options** and choice one of the following functions that may be available for the selected files:

- ◆ **Play:** play the video.
- ◆ **Set as:** Set the video to Contacts, Screen saver, or send the video via MMS or Bluetooth.
- ◆ **Send:** You can use the video to send MMS and Bluetooth

- ◆ **Rename:** Change the name of the file.
- ◆ **Delete:** Delete the file.
- ◆ **Delete all:** Delete all the recorder files.
- ◆ **Sort:** To sort the file by File name, File type, Time, File size and None.
- ◆ **Storage:** Storage place in phone or memory card.

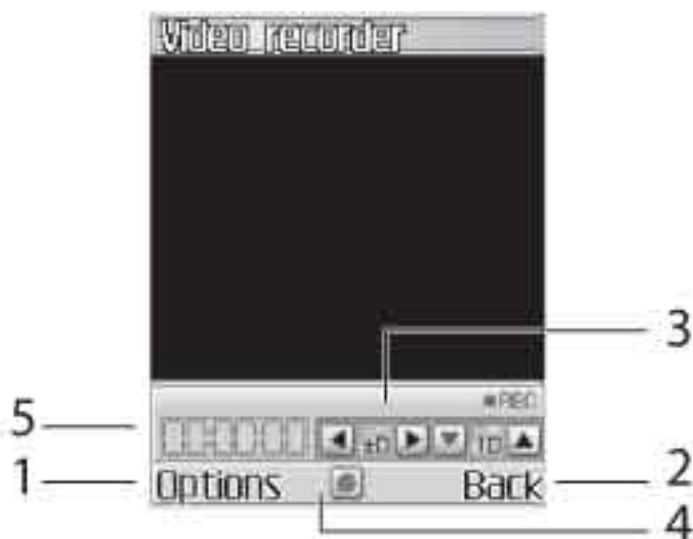
# Video Recorder



1. Press  (LSK) to choose video recorder options, press  (RSK) to back to previous level or saving recording.
  2. Use the navigation key up/down adjust zoom in/zoom out.
  3. Use the navigation right/left adjust this EV
  4. Press  center key to start record video.
  5. Area used for displaying recorder time.
- To record a video clip
    1. Press Menu, and select Multimedia and Video recorder.
    2. The live image appears on the display, and you can use the display as a viewfinder.
    3. To record a video clip, press  center key.
    4. The phone saves the video in the Video player of the Multimedia menu. For detail information about playing video, see Video player.

- To setup video recorder option  
Enter options list. User can select:
  - **Video recorder settings:** The settings including - White balance / EV/ Night mode / Banding. For detail see table below.
  - **Video settings:** The settings including Video quality / Rec time limit / Record audio. For detail see table below.
  - **Effect settings:** Apply a special effect to the photo, the detail option see below table.
  - **Storage:** Select storage place in phone or memory card.
  - **Restore default:** to restore video settings to default.

	<b>Video recorder options</b>
White balance	Auto / Daylight / Tungsten / Fluorescent / Cloudy / Incandescence
EV	EV+1 ~ EV+4 / EV0 / EV-1 ~ EV-4
Night mode	On / Off
Banding	50 Hz / 60 Hz
Video quality	High / Normal / Low / Fine
Rec time limit	No limit / 15 sec / 30 sec / 60 sec
Record audio	On / Off
Effect settings	Normal / Gray scale / Sepia / Sepia green / Sepia blue / Color invert
Restore default	Restore video recorder settings to default

# Sound Recorder

**Voice Recorder** is a simple voice recording application, which provides functionalities for the user to manage voice files.

Within **Recorder/List** submenu, press **Options** you can select:

- **Record:** To record new sound.
- **Play:** Play the selected sound.
- **Append:** To append the new sound with the already existing sound (for AMR format only).
- **Rename:** To modify the name of the selecting sound.
- **Delete:** To delete the selected sound file.
- **Delete all:** To delete the entire available sound files.
- **Settings:** The further setting of recorder
  - **Storage:** Select file storage in **Phone** or **Card**.
  - **File format:** There are two types format setting: AMR or WAV.
- **Set as :** To forward the sound file to "To incoming call tone", "To message tone", "To MMS" or "To Bluetooth".
- **Mark:** To mark the record file.

## Photo Gallery

**Photo album** is a folder under **Multimedia**; it is a folder to save the photo images. You can view image in this folder. Press **Options** and choice one of the following functions that may be available for the selected files:

- **View:** To view the photo.

When you viewing the photo, press navigation  to the image, and press navigation key up/down can change the image

- **Image info:** To display image detail information.
- **View mode:** To select image display style.
- **Set as:** You can use the photo to Wallpaper and Screen saver or to Contacts,
- **Send as:** You can use the photo to send MMS and Bluetooth.
- **Rename:** Change the name of photo.
- **Delete:** Delete selected photo.
- **Delete all:** Delete all photos in the photo gallery.
- **Sort:** To sort the file by File name, File type, Time or File size and None.
- **Mark:** You can choose many photos to delete or copy.

## FM radio







To listen to the FM radio on your phone connects the compatible headset connector on the left side of the phone. Note that the quality of the radio broadcast depends on the radio station's coverage in that particular area.

[Note] : Long press  can be use FM function.



- To turn on the radio
  - Press **Menu** and select **FM radio**.
  - Press Navigation  direction to activate FM radio.

- On the display are:
  - Channel location number and the name of the radio channel if you have saved the channel.
  - Frequency of the radio channel.
  - Channel location number and the name of the radio channel if you have saved the channel.
  - Frequency of the radio channel.
- If you have already saved radio channels, you can scroll to the channel you would like to listen to or select a radio channel location 1 to 10 by pressing the corresponding number key.



- Search a radio channel







When the radio is on, press navigation up/down  /  can adjust the increase and decrease volume then long press navigation left/right direction  or  key to auto search of previous stations and next stations channel Or you can short press navigation left/right direction  or  key to skip 0.05MHZ

- Saving radio channels

To save channels quickly in positions 1-10, press and hold number key  to  Selecting a channel you want to save in position 1-20, and press key 1-20.

- FM recorder

To record FM radio, press  /  (option) key selection the FM recorder.

	Navigation key center key	power on/off
	Up	increase volume
	Down	decrease volume
	Left	⏮ short press to skip 0.05 MHz long press: auto search of previous stations
	Right	⏭ short press to skip 0.05MHz long press :auto search of next stations
	Main menu	Enter radio option list
Key 0 ~ 9		To change radio channel, by pressing the corresponding number key.

- Using the radio

When the radio is on, press  key and select.

- Stations:** To save the channel you have found, press and select **Edit**. Key in the name of the channel and Frequency press **OK**. You can save 20 radio channels in the handset.
- Set frequency:** If you know the frequency of the radio channel you would like to listen to (between 87.5 MHz and 108.0 MHz), key it in and press **OK**.

- **Auto Tuning:** If you want to search radio channel, press **Yes** when Preset list confirm message showup. The search stops when channels has been found and show channel in **Stations**.
- **Record:** Beginning record FM radio.
- **Append:** To append new radio with the already existing file.
- **File list:** Show amount of record files.
- **Settings:** FM radio setting options:
  - **Background play:** Turn On/Off Background plays function.
    - **On:** allow radio continuing playing when exit FM radio.
    - **Off:** when user exits FM radio, radio will stop.
  - **Record format:** Select the record format, AMR/WAV.
  - **Loud speaker:** Turn On/Off the Loud speaker function.

**Note:** Before use FM radio option, please turn on the radio first.

**Note:** You can normally make a call or answer an incoming call while listening to the radio. The volume of the radio is muted. When you end the call, the radio volume will automatically be turned up again. Also, when an application using GPRS or HSCSD connection is sending or receiving data, it may interfere with the radio.

## Scheduler FM Recording

- Press **Menu**, select **Media center/FM radio recorder scheduler**, press **OK** to enter submenu of **FM radio recorder scheduler**.
- To set the recorder scheduler, press **Edit** and set on the radio, key in the date, and time to start and stop.
- You can repeat the recorder to Everyday, Once, Days, Weekly or Monthly.

## JAVA

This device supports JAVA, providing you the freedom of using JAVA applications and games. You can into the "File manager" and choose the JAVA game to install.

- Java setting

This function designs for **JAVA** only.

- Java audio: Off, Level 1 ~ Level 7.
- Java vibration: Turn On / Off vibration of java game.
- Java heap size: Reveal the capacity size that can be used

### Alarm

The alarm clock uses the time format set for the clock.

- Press **Menu**, select **Organizer/Alarm clock**, press **OK** to enter submenu of **Alarm clock**.
- To set the alarm, press **Edit** and set on the alarm, key in the alarm time. You can set at 5 lists.
- You can set the alarm to repeat, **Once**, **Days** or **Everyday**.
- **MP3** and **FM** can be used as alarm tone.

[Note]: Headset be plugged in the user assigns the **FM** as alarm tone.

- Press **Stop** to stop the alarm. If you let the phone continue to alarm for a minute or press **Snooze**, the alarm stops for about 5 minute and then resumes.
- If the alarm time is reached while the phone is switched off, the phone switches itself on and starts sounding the alarm tone, if you press **Stop**, the phone ask whether you want to active the phone (**Power on?**). Press **No** to switch off the phone or **Yes** to switch on the phone.

### Calendar

- You can use the phone's calendar to keep track of reminders, calls you need to make, meetings and birthdays. You can set the calendar to sound an alarm when it's time for you to make a call or to go to a meeting.

- Press **Menu**, select **Organizer/Calendar**. Press **Options** to the options list, you can **Add task, View, week view, Jump to date**.
- Calendar display depend on user setting calendar format in the Calendar setting, for example: you can select Thai Calendar when language setting is Thai mode
- If you want to add new task, within the calendar submenu, use Navigation key move to the day you want or use Go to date option the current day is indicated with a frame around the day. If there is any tasks set for the day, the day is changed display icon. To view the appointments, press **OK** to **Edit** and **Delete**.

## To do list

- In this function, you can **View** the task, **Add task, Edit task, Delete task**, and **Delete all** the list of tasks. You can also select and view a single task.
- The task view allows you to view the details of the select task. You can move through the task.
- When setting time is coming, the alarm notification is enable, the phone will remain user his activities.

## Memo

- In this function, you can **Add** the memo, **View** the memo, **Edit** memo, **Send Note**, **Delete**, and **Mark** the list of memo. You can also select and view a single memo.
- The memo view allows you to view the details of the select memo. You can remember through the memo.
- When view this memo, you can press options to **Edit**, **Send Note** or **Delete** this memo.

## World clock

- The screen shows the city name, current date and time.
- You can press Navigation key to choose the city and check the local time.
  - The time zone setting of each city in world time menu may be affected by network condition.

## Health

Application program to offer a series of for health consultation, BMI, Menstrual, let you finish body and mind clever health care at the same time.

## User Profile (Menu 10)

Within the Profiles menu, you can adjust and customize the phone tone for different events, environments and caller groups.

- **Activate**

- In the idle mode, press **Menu** and select **User Profiles** and press **OK** to access the list of profiles.
- Use Navigation key to select the profile. Pressing **Options** to activate and customize the profile.

- **Customize**

- Within Profile submenu, select one of the following profiles and press **Options**.
  - General / Silent / Meeting / Outdoor / Headset / Bluetooth. Use Navigation key to select the profile. Press Options to customize the profile.
- In the idle mode, user can hold and press the  to change profiles to **Silent** quickly and easily. Or in the list of profiles, scroll to **Silent** and press **Options/ Activate Silent** mode.
- Select the **Customize** and choose the desired option and press **OK** that you want to personalize. For example, Tone setting, Volume, Alert type, Ring type, Answer mode, Extra tone.



Once you have selected the setting customize, you can personalize the following settings of the selected profile:

## Tone settings

- **Incoming call:** To define how the phone notifies you of an incoming voice call.
  - **Keypad tone:** To set any one of the options and the active one is highlighted.
  - **Power on:** To set any one of the options and the active one is highlighted.
  - **Power off:** To set any one of the options and the active one is highlighted.
  - **Message tone:** To define how the phone notifies you of receiving a message.
- \* Ring tone can support these formats: MP3, VDO + sound, Midi, AMR and also can select files from NAND or Memory Card. Message tone can also support MP3 (no longer than 5 seconds), Midi and AMR formats.
- **Volume:** To set the volume level for the Ringing volume, Key tone and Message tone.
  - **Alert type** to choose the phone notifies you for incoming calls and receiving a message. The options are: Ring /Vibration only / Vibrate and ring / Vibrate then ring / Light only / Beep once.
  - **Ring type:** To set the ring type, the options have Repeat, Single and Ascending.
  - **Answer mode:** To set the phone answer incoming voices call by press any key.
    - The answer mode have two options Send key and Any key options.

- Extra tone: To set the Warning tone, Error tone, Camp-on tone, Connect tone, Miss Calls and Unread Messages On or Off. For example, when set Extra tone function to on, the phone sounds a warning tone when the battery is running out of power.
- Rename  
You can change the name of selected profiles.

### Calculator

- You can use your phone's calculator to add, subtract, multiply and divide.
- Press **Menu**, select **Organizer/Calculator**, and press **OK**.
- With the screen showing a "0", enter the first number in the calculation.
- Use Navigation key to select add, subtract, multiply, and divide then press **OK** or center key to continue operation.
- Press  to enter a decimal point.
- Press  do the percentage to convert.  
Press **Clear** to start the new calculation.

### Unit converter

- To convert measures such as Weight from one unit (Pound) to another (Kg), press the **Menu**, and select **Organizer** then **Unit converter**.
- In the **Unit converter** submenu, press **Options** to select converter options, option in **Set weight converter** is **Reverse converter** and **Set converter**.

**Note:** the Converter option display is depending on user settings

- In the first amount field, and enter the value you want to convert, the other amount field automatically shows the converted value. For example, in weight converter, pound units expressed in kg units, enter 110 and 49.895164 automatically show in kg field.
- Press Navigation key up/down to reverse converter, or press **Options** to select reverse converter option.
- If you want to select other converter types, press **Options** and select **Set converter** to open a list of measures. Choose the measure you want to use and press **OK** to enter converter unit list.
- Choose the converter unit from which you want to converter and press **Options\Activate**.

## Stopwatch

You can measure time, take intermediate times, or take lap times using the stopwatch. During timing, the other functions of the phone can be used. To set the stopwatch timing in the background, press the end key.

Using the stopwatch or allowing it to run in the background when using other features increases the demand on battery power and reduces the battery life. The stopwatch continues to run when you answer an incoming call.

<b>Split timing:</b>	To take intermediate times. To start the time observation, press <b>Start</b> , press <b>Split</b> every time that you want to take an intermediate time. To stop the time observation, press <b>Stop</b> . To save the measured time, press <b>Save</b> . To start the time observation again, press <b>Resume</b> , the new time is added to the previous time.
<b>Lap timing:</b>	To take lap times. To set the stopwatch timing in the background presses the  (End key).
<b>Count down timer:</b>	To count down timer. Set up the time of count down timer, and then begin to count down according to press <b>Start</b> .
<b>View record:</b>	To view the saved time. The record options have: <b>View</b> , <b>Delete</b> and <b>Delete all</b> .



## Services (Menu 12)

Your phone supports both SIM Service and WAP (Wireless Application Protocol) services. These services allow you to browse all kinds of information such as news, weather reports, flight schedules, dictionaries, etc. Even more, you can connect to the Internet and go to your favorite WAP enabled web sites. The following sections explain how to setup and use these wonderful services.

### STK

In addition to the functions available in the phone, your SIM card\* may provide additional services under the SIM service submenu\*\*. By entering the submenu, you can find a list of services provided by your operator. The requested information may be responded via voice speech or SMS (Short Message Service). Additional charges may apply for services involve sending a SMS or making a phone call.

**Note:** • Some SIM cards may not support SIM service. In such case, you won't be able to see the SIM service submenu.

- SIM service varies from operator to operator. The name and contents of the menu depend entirely on the SIM card provided by your operator. For availability, rates and information on using the SIM service, contact your network operator, service provider or other third-party vendor.

## WAP

The WAP service enables your phone to surf the Internet. Your phone offers you several default profiles to choose from. These default profiles are based on the connection settings of major operators at the time this phone was manufactured. You can apply the desired connection settings by simply activating the respective profile, and you are ready to go.

- **Homepage**

- For each profile you are allowed to store a "Home URL" (Universal Resource Locator) address. You can quickly access the homepage of the active profile by selecting "Home URL" when the WAP menu is displayed.

- **Bookmarks**

You can save the addresses of web pages as bookmarks in the phone's memory.

- Press **Menu**, and select **Services, WAP** and **Bookmarks**. Choose the bookmarks you want to use and press left soft key (Options). And then you can:

<b>Goto:</b>	Open a connection to the page associated with the bookmark
<b>Edit:</b>	Edit the select bookmark
<b>Delete:</b>	Delete the select bookmark
<b>Add bookmark:</b>	Add a new bookmark by entering the title and URL address

- **Recent pages**

You can view the recent pages that you have read. And you can press left soft key (Options), then you can:

<b>Goto:</b>	Connect to the select page
<b>View URL:</b>	View the select page's URL
<b>Delete:</b>	Delete the select bookmark
<b>Delete all:</b>	Delete all select bookmark

- **Go to URL**

- Key in the URL address and press **OK** to connect to the address.

- **Settings**

- **Edit profile**

- The WAP settings are stored in a WAP profile. In most cases you only need to use one of the default profiles to access the Internet. The settings are different from operator to operator. Please consult

your operator or service provider for the correct settings and proceed with care. Wrong settings will cause the connection to fail.

- Within **Edit profile** submenu, press **OK** key to enter profile-editing list. And then you can:

<b>Activate profile:</b>	Active the select WAP profile
<b>Rename profile:</b>	Rename the selected WAP profile
<b>Homepage:</b>	Enter a title and address of the WAP web site as the homepage. You can only have a homepage for each profile.
<b>Data account:</b>	Users are only allowed to choose a data account. The list of the accounts should be consistent to those under Service menu - Data account.
<b>Connection</b>	Select <b>Connection-oriented</b> or <b>HTTP</b> from the list.
<b>User name:</b>	Enter your user ID for the WAP gateway
<b>Password:</b>	Enter your user password for the WAP gateway

- **Browser options**

<b>Time out:</b>	Set the timeout value for the browser. The browser will stop connecting to the web site if the web site does not respond within the timeout time.
<b>Show images:</b>	Set option <b>On/Off</b> to view pictures while browsing.

- **Service message settings**

Turn **Off** or **On** to decide whether you want to receive the service message or not. The message is saved in the Service inbox.

- **Clear cache**

- The information or data you have accessed are stored in the cache of the phone. A cache is a file buffer that is used to store data temporarily.
- Within **Settings** submenu, select **Clear cache**, and press **OK**.

- **Clear cookies**

- It is advisable to clear any sensitive information like cookies of previously visited web sites. This is to avoid privacy and security risks if your phone is misplaced, lost or stolen.
- Press **OK** to clear all the cookies

## • Clear recent page list

- It is advisable to clear any sensitive information
- About previously visited web pages in Recent Page List. This is to avoid privacy and security risks if your phone is misplaced, lost or stolen.
- Press **OK** to delete all the recent pages.

## • Trusted certificates

- For using some services, such as banking services, you need security certificates. After you have downloaded the required security certificate from the Internet, you can view the certificate and then save or delete it. If you save it, the certificate is added to the list of trust certificates under the **Settings** of **WAP** menu.
- View the list of Trusted Certificates:
  - Press **Menu**, select, **Services, WAP, Settings, Edit profile**, and **Trusted certificates** press **View** key.
- If the security indicator is displayed during a connection, the data transmission between the phone and the gateway server is encrypted. However, the security indicator does not indicate that the data transmission between the gateway and the content server (the location where the requested resource is stored) is secure. It is up to the service provider to secure the data transmission between the gateway and the content server.



## Data account

Connect way while choosing the mobile phone to browse through the WAP. Detailed materials setting up value, please arrange with a network supplier

## To Use Mass storage (USB cable)

**Note:** System default requirement: PC hardware and software for Windows 2000/XP and above. For more information, please see below "Install USB Software for Windows 2000"

**Note:** Please use USB according to the standard steps as below; otherwise the data may lose or cause damage.

If you want to add/remove music and images to the Handset, connect it to a PC with USB cable.

- Plug in cable (USB) to handset and PC, screen show three options:
  - Mass storage mode: for add / remove music or image files.
  - COM port: as USB charger.

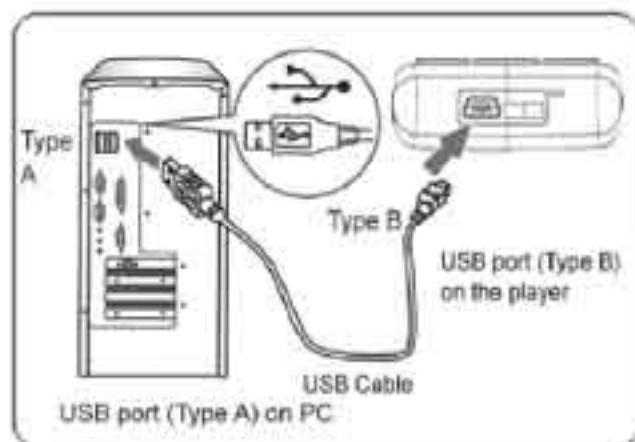

- Connecting the handset to PC
  - After connected the handset and PC, choice “Mass Storage” handsets will automatic turn off.
  - The OS will automatically generate two “**Removable Disk**” in My Computer, one for handset, one for memory card. You can enter the disk to access the data in the handset.
  - You can access to the handset from the Window Explorer (Windows 2000/XP) / **File Manager** or **My Computer** and add / erase audio, image or other files to the handset.
  - If you want to remove the USB cable from the handset after adding or erasing files
    - Double click the Remove Hardware icon in the taskbar tray.
 
    - Select “USB Mass Storage”, then clicks **Stop** when the message “You can remove hardware now” appears on the screen, and remove the handset.
- Copy files into the handset
  - After connecting the handset to a PC successfully, there will be two new disks “Removable Disk” in My computer.

Enter the directory stored your music, image, or other files, and select them thru your mouse. After selection, move your mouse on the selected files and click right button of your mouse to select "**Copy**", enter the **Removable Disk** from My Computer, and click right button of your mouse to select "Paste" then the selected files will be copied into the handset.

