

# NOKIA NOKIA 1600 1110

RH-64

RH-70



### Transceiver characteristics:

- **Band:** Dual-band phone for GSM 900/1800MHz or 850/1900MHz (depends on Sales Area)
- **Display:** High resolution color display with up to 65,536 colors (128 x 128 Pixels)  
Inverted black and white display (Nokia 1110 Only)
- **Vibra Alert:** Onboard Vibra motor
- **Connector:** Easy Flash connector

Transceiver with BL-5c 900mAh Li-Ion battery pack

Talk time	Standby	Note
Up to 5h	Up to 18days	Depends on network parameters

### Environmental characteristics:

- Lead-free soldered

## SERVICE MANUAL

## Service Level 1&2

**TABLE OF CONTENT**

	<b>Page</b>
1. INTRODUCTION.....	3
2. GENERAL REPAIR INFORMATION.....	4
3. PATHFINDER FOR WORKSHOP STAFF.....	5
4. EXPLODED VIEW AND COMPONENT DISPOSAL.....	6
5. SPARE PARTS OVERVIEW.....	7
6. SPARE PARTS LIST.....	8
7. SERVICE TOOLS.....	9
8. SW-UPDATE.....	11
9. DISASSEMBLY INSTRUCTIONS.....	12
10. LEGEND FOR QUICK TROUBLE SHOOTER.....	15
11. QUICK TROUBLE SHOOTER PART 1.....	16
12. QUICK TROUBLE SHOOTER PART 2.....	17
13. GONOGO TEST.....	18
14. BATTERY TEST.....	18
15. FORWARDING OF REPAIRS.....	19
16. ESD PROTECTION REQUIREMENTS.....	20

**CHANGE HISTORY**

Status	Version No.	Date	Comments
Draft	0.1	07.06.2005	Initial draft
Approved	1.0	23.06.2005	Approval

## 1. INTRODUCTION

The purpose of this document is to help NOKIA service levels 1 and 2 workshop technicians to carry out service to NOKIA products. This Service Manual is to be used **only** by authorized NOKIA service suppliers, and the content of it is **confidential**. Please note that NOKIA provides also other guidance documents (e.g. Service Bulletins) for service suppliers, follow these regularly and comply with the given instructions.

While every endeavor has been made to ensure the accuracy of this document, some errors may exist. If you find any errors or if you have further suggestions, please notify NOKIA using the address below:

<mailto:cc-ts-rc.documentation@nokia.com>

Please keep in mind also that this documentation is continuously being updated and modified, so watch always out for the newest version.

### Warnings and Cautions

Please refer to the phone's user guide for instructions relating to operation, care and maintenance including important safety information. Note also the following:

#### Warnings:

1. CARE MUST BE TAKEN ON INSTALLATION IN VEHICLES FITTED WITH ELECTRONIC ENGINE MANAGEMENT SYSTEMS AND ANTI-SKID BRAKING SYSTEMS. UNDER CERTAIN FAULT CONDITIONS, EMITTED RF ENERGY CAN AFFECT THEIR OPERATION. IF NECESSARY, CONSULT THE VEHICLE DEALER/MANUFACTURER TO DETERMINE THE IMMUNITY OF VEHICLE ELECTRONIC SYSTEMS TO RF ENERGY.
2. THE HANDPORTABLE TELEPHONE MUST NOT BE OPERATED IN AREAS LIKELY TO CONTAIN POTENTIALLY EXPLOSIVE ATMOSPHERES EG PETROL STATIONS (SERVICE STATIONS), BLASTING AREAS ETC.
3. OPERATION OF ANY RADIO TRANSMITTING EQUIPMENT, INCLUDING CELLULAR TELEPHONES, MAY INTERFERE WITH THE FUNCTIONALITY OF INADEQUATELY PROTECTED MEDICAL DEVICES. CONSULT A PHYSICIAN OR THE MANUFACTURER OF THE MEDICAL DEVICE IF YOU HAVE ANY QUESTIONS. OTHER ELECTRONIC EQUIPMENT MAY ALSO BE SUBJECT TO INTERFERENCE.

#### Cautions:

1. Servicing and alignment must be undertaken by qualified personnel only.
2. Ensure all work is carried out at an anti-static workstation and that an anti-static wrist strap is worn.
3. Use only approved components as specified in the parts list.
4. Ensure all components, modules screws and insulators are correctly re-fitted after servicing and alignment.
5. Ensure all cables and wires are repositioned correctly.



Electrostatic discharge can easily damage the sensitive components of electronic products. Therefore every Service Supplier has to take care of all precautions, which are mentioned in the service level related "Service Partner Requirements", available on NOKIA Online. Also see ESD Protection Requirements in this Service Manual.

## 2. GENERAL REPAIR INFORMATION

In this section the technician will get some general hints how to carry out repairs:

- To familiarize oneself with NOKIA product read the tutorials or user guide on [www.nokia.com](http://www.nokia.com) -->Support--> Phones, by selecting the Phone Model.
- Before starting the repair you must take care of ESD precautions like being in your ESD Protected Area and connecting your wristband.
- Use gloves to avoid corrosion and fingerprints.
- Protect windows and displays with a film to avoid dust and scratches.
- When cleaning the LCD Module any lint-free cloth can be used (e.g. Micro-Fibre cloth).
- When cleaning the pads you have to use a soft cloth/ESD brush and Isopropanol. It is not allowed to use a glass fiber pencil because it scratches the surface and will lead later on to corrosion.
- Mechanical parts (except shielding lids and bent parts), which didn't repair the failure, can be reused, if they are not soldered.
- When removing the shielding lids make sure to replace them with new ones, otherwise the high-frequency leakage can have an influence on the device.
- Always use original NOKIA spare parts.
- Check the soldering joints of the parts, which are concerned regarding the indicated error (e.g. soldered connectors or switches) and resolder them if necessary (Level 2 only).
- Remove redundant soldering flux after repair.
- Meet the torque requirements when assembling the unit (see also the document "torques for transceiver assembly" on NOKIA Online).
- Always use your own equipment for testing where you are sure that it works. E.g. if the customer complains about charger function, please test the phone with your own charger to be sure if phone or charger causes the malfunction.
- A SIM card is needed for all GoNoGo tests.
- When doing the fault log entries, always note the Item code, which caused the malfunction. Also, fill in the appropriate part code from the assembly, if needed.
- Please be aware that some malfunctions could be software related and solved by an update.
  
- There are several documents available on NOL, which have to be followed:
- First, take care for the latest content pages of Service Bulletins, which are always available for each folder on NOKIA Online. This is also important to recognize, if existing documents have become invalid.
- The service level indicator at the bottom of each document tells the appropriate destination.

**Example:**

**Downloads > Support Library >**

1. Instructions
  2. General Service Bulletins
  3. Product related documents
  4. Spare Part Service Bulletins
  5. Service Tools Service Bulletins
  6. Common Software Service Bulletins
- etc,...

**Please also check NOKIA Online (NOL) for latest news and files on a regular basis.**

### 3. PATHFINDER FOR WORKSHOP STAFF

In addition to the information in this Service Manual, there are several instructions and information, which have to be followed. Main documentation database is [NOKIA Online](#) with the purpose of serving different multimedia content, like video clips or interactive tutorials.

It is mandatory to watch for newest technical and organizational information on a daily basis to be updated as required (see “**Latest files in Support Library**”). Every new information has to be processed and implemented as soon as possible.

When logged into NOL you can also find needed information in different folder like:

#### Support Library

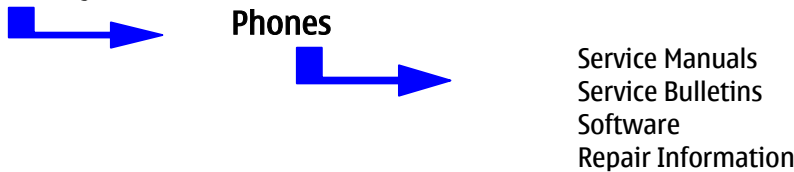

#### Level 1&2 e-learning (former NOKIA CarePoint) on NOKIA Online

Former NOKIA CarePoint content, such as	<ul style="list-style-type: none"> <li>• Online Troubleshooting</li> <li>• Product information</li> <li>• Videos – Disassembly/Assembly</li> </ul>	can be found on NOKIA Online
		<p><a href="#">NOKIA Online</a></p> <p>↓</p> <p>Care Services</p> <p>↓</p> <p>Training</p> <p>↓</p> <p>Phone Models</p>

Level 1&2 e-learning courses offer a quick overview of the NOKIA phone and support for how to repair and use the phone:

<p><b>Overview &amp; Guides</b>          Basic information about the phone, features and technologies</p>	<p><b>Disassembly &amp; Assembly</b>          Instructions how to disassemble and assemble the phone</p>	<p><b>Troubleshooting</b>          Step-by-step instructions on how to locate and repair the most common problems with the phone</p>
---	--	--

To reduce the server traffic it is recommended to download newest version of huge files like videos, Phoenix packages or Service Manuals only once and distribute it internally for further use.

### 4. EXPLODED VIEW AND COMPONENT DISPOSAL

Recommendation for the ecologically friendly disposal of components. Colorized components show the different categories. See corresponding ITEM/CIRCUIT REF in the Spare Parts Service Bulletins on NOL.

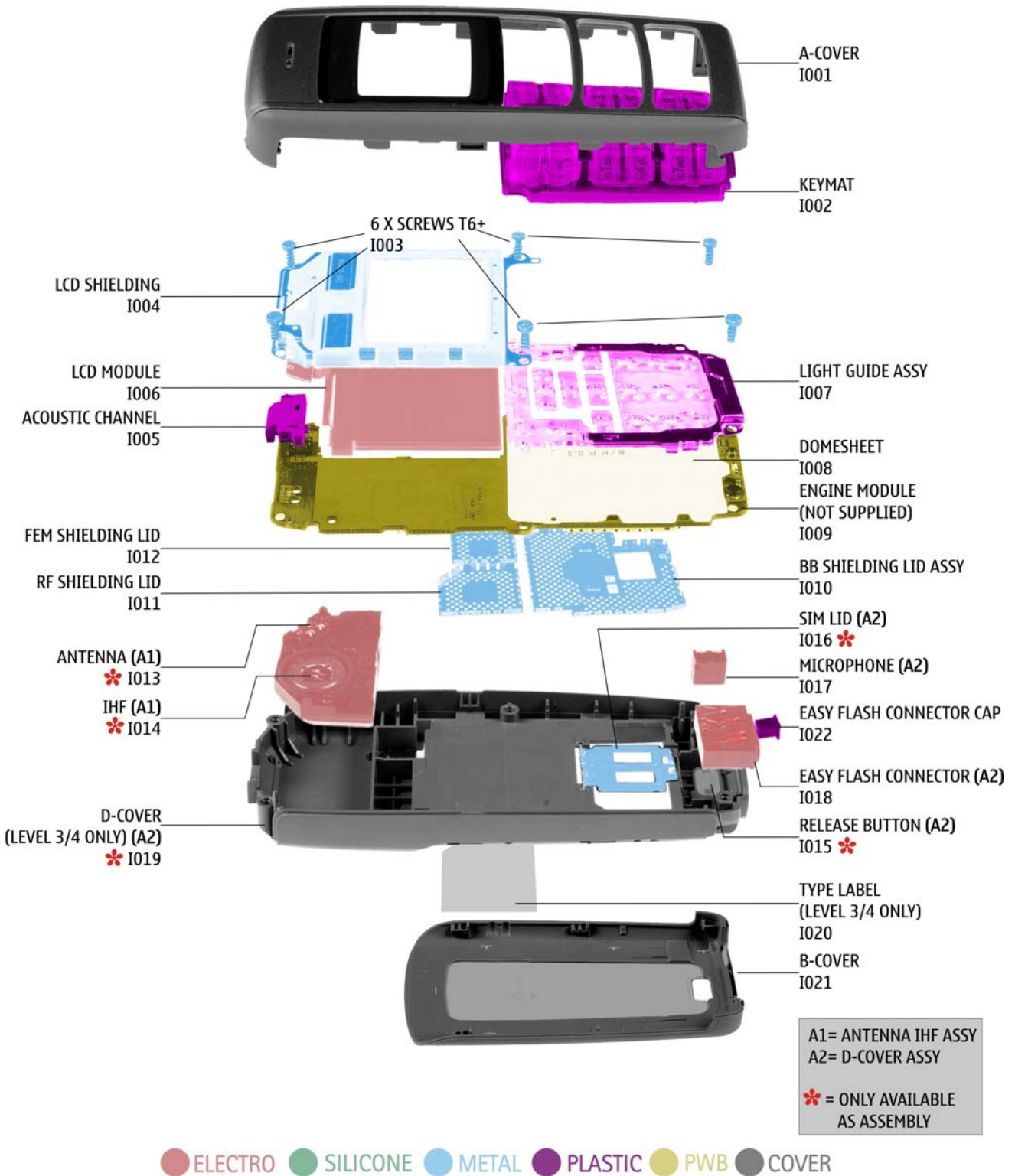

**5. SPARE PARTS OVERVIEW**



**COMMON**

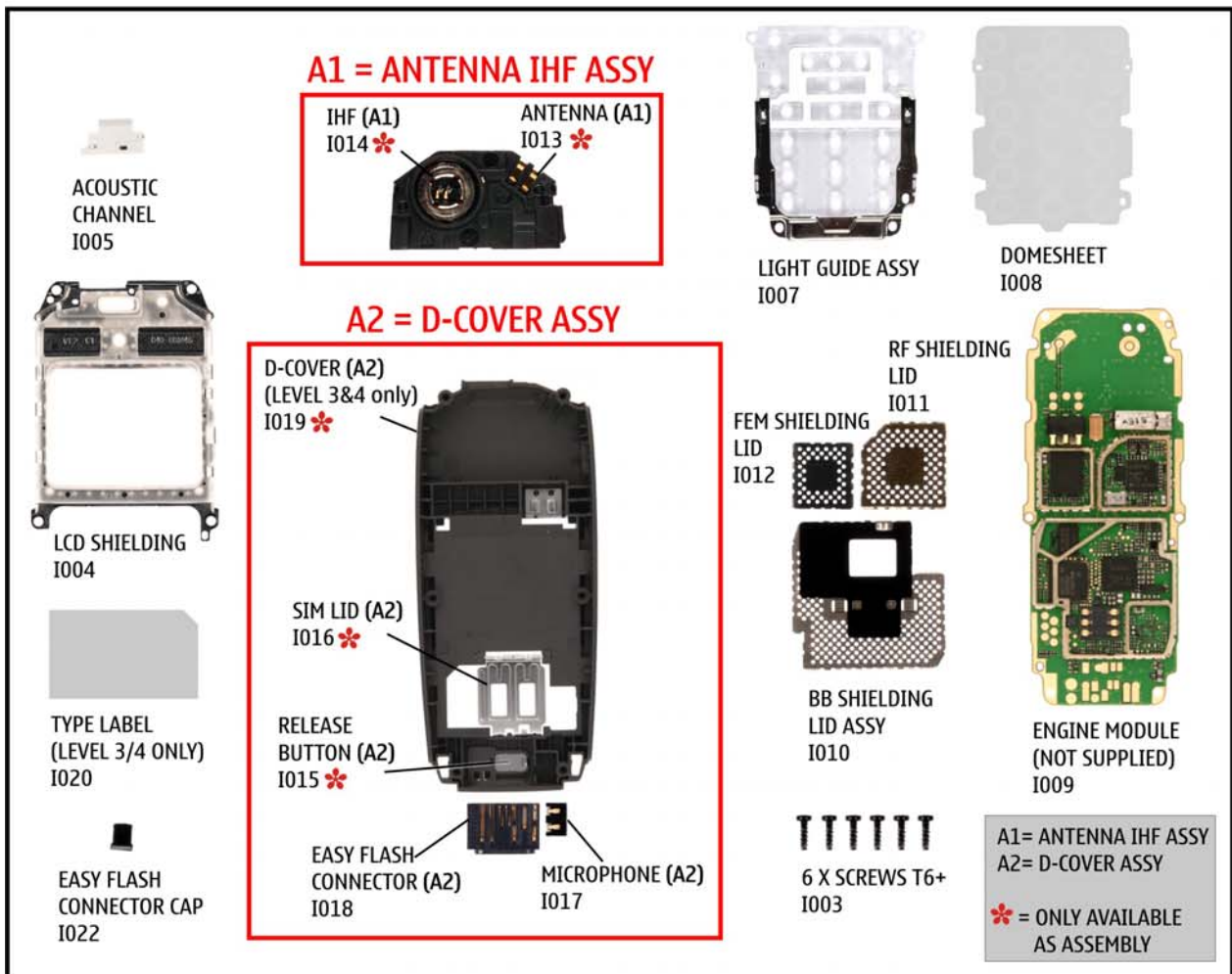

## 6. SPARE PARTS LIST

Please exchange this page (placeholder) with latest corresponding Service Bulletins (spare parts, SWAP units and service tools) from NOL!

This will ensure, that you are using up-to-date order codes only.

Therefore Service Bulletins have to be checked from NOL on daily basis.

---



**NOKIA**  
CONNECTING PEOPLE

Nokia Online

Home | User | Sitemap | Log Out

Search

Care Services  
Support Library | Warranty Info | Service Points | Training

### Support Library

#### Browse files

Latest files  
→ Browse files

Select category:   
Select subcategory:   
Select subcategory:

Date range from  /  /   
until  /  /

Search

**Files for Service level 2** Date:03.02.2005

- xxxxxxxxxxxxxxxxxxxxxxxx







**Files for Service level 1** Date:16.02.2005

- xxxxxxxxxxxxxxxxxxxxxxxx
- xxxxxxxxxxxxxxxxxxxxxxxx
- xxxxxxxxxxxxxxxxxxxxxxxx

© Nokia 2005 [legal notice and site usage terms](#) | [privacy policy](#).



## 7. SERVICE TOOLS

	<p><b>FLS-4S incl. ACF-8, Driver and User Guide</b> Dongle and flash device incorporated into one package, developed specifically for POS use.</p>
	<p><b>Internal Battery BL-5C</b> Inserted under the back cover, this Li-Ion 900 mAh battery provides power in a lightweight package.</p>
	<p><b>Travel Charger ACP-12</b> Small and lightweight charger for fast charging of your phone battery.</p>
	<p><b>Headset HS-7</b> Comfortable handsfree operation with a remote control button for answering and ending calls makes this headset convenient and easy-to-use.</p>
	<p><b>XCS-1</b> Service Cable is used to connect FLS-4S to SF-10 .</p>
	<p><b>SF-10</b> POS Flash Adapter is used in POS (Point of Sales) environment for software updating. It provides controlled supply voltage and necessary connections between the phone and the Flash Device. It substitutes for the phone's standard battery during the software update.</p>



**Test Pins**  
for Flash Adapter SF-10



**RJ-79**  
Soldering Jig



**Lead-free Solder Wire**  
Mandatory for lead-free products (Level 2 only).



**0772040 NMP Standard Toolkit**

- NOKIA opening tool SRT-6 NOKIA No. 0770431
- Tonichi torque driver NOKIA No. 6901525
- [Hoya](#) micro fibre cloth MX304
- [Dastex](#) gloves S, M, XL
- [Artlux](#) goggles AH166
- [Wera](#) bit T5 867/4TX 5x50
- Wera 867/4 6IP; 50mm (Torx 6 PLUS®)
- Wera bit T6 867/4TX 6x50
- Wera 867/1 5IP; 25mm (Torx 5 PLUS®)
- Wera bit T6 PLUS® 867/4TX 6IP
- [Facom](#) side cutter 416E
- Facom T5 driver SP.14032
- Facom T6 driver SP.14033
- Facom slot screwdriver AEF. 2x35.E
- [Wetec](#) tweezers 7abb SA-ESD
- Wetec tweezers 22 SA-ESD
- Wetec tweezers 13 SA-SMD ESD
- Wetec tweezers PSF SA-ESD
- Wetec ESD brush E1211
- [Kaiser](#) Fototechnik airbrush 6315
- Wetec dental tool DEM83266/0
- [RS Components](#) Scissors 323-5732

## 8. SW-UPDATE

### Flash Concept – (Point of Sales)

To use FLS-4S Flash Dongle you have to follow the user guide inside the sales package. Please check always for the latest version of flash software, which is available on [NOKIA Online](#).

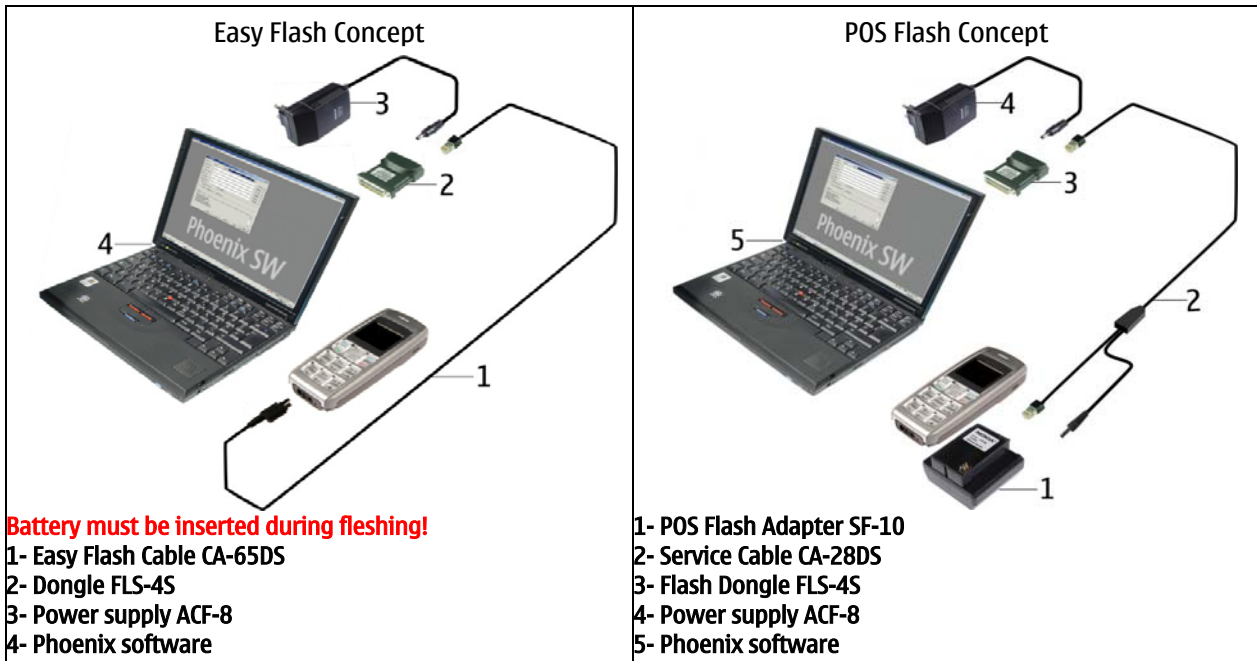

It is very important to follow this insertion and removal procedure, otherwise the contact pins of Flash Adapter will be damaged (only for POS Flash Concept).



Insert the Flash Adapter SF-10 like a battery, start at the Battery Connector side.



Now, push down the bottom side of the phone, do not use too much force.



When removing the phone, always start from the bottom side of the unit.



Now, take the unit away.

## 9. DISASSEMBLY INSTRUCTIONS



1.) Needed tools for disassembly and assembly.



2.) Protect the window with a film.



3.) Press the **Release Button** and remove the **B-Cover**.



4.) Use the SRT-6 to unlock the **A-Cover** on both sides.



5.) Remove the **A-Cover**. **Always start on the top side of the device when re-assembling the A-Cover.**

**For Nokia 1600 only!**



6.) Remove the **Keymat** and protect the inner side of the window with a film.

**For Nokia 1110 only!**



7.) Use SRT-6 to remove the **Keymat** and protect the inner side of the window with a film.

**For Nokia 1110 assembly only!**

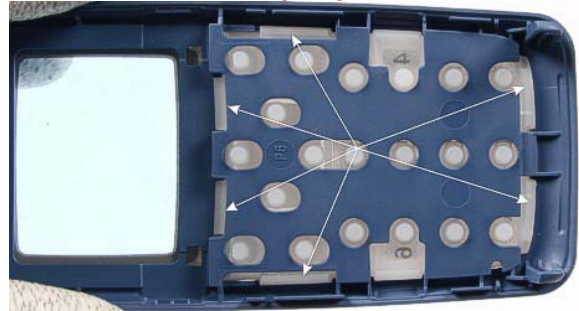

8.) Fit the **Keymat** to the **A-Cover**, paying attention to its correct position.

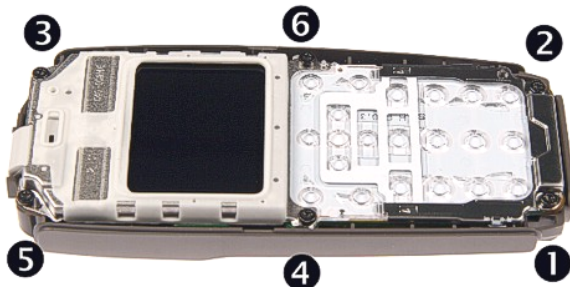

9.) Unscrew the six, Torx Plus® size 6 screws in the shown order. **For assembly, use the reverse order and a Torx Plus® size 6 driver with a torque setting of 24Ncm.**



10.) Lift the **LCD Shielding** while pressing on the **LCD Module** with a clean cloth carefully.



11.) Remove the **LCD Shielding**.



12.) Remove the **Acoustic Channel**.

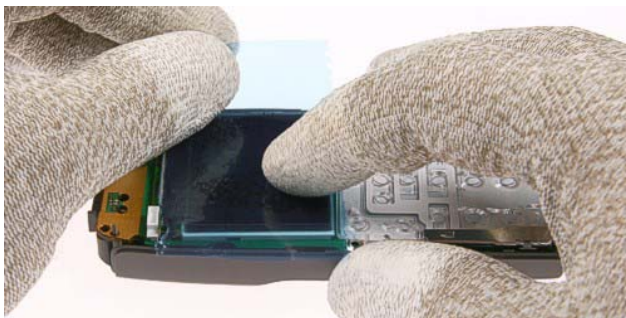

13.) Protect the **LCD Module** with a film.

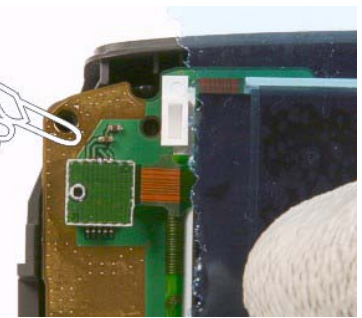

14.) Take care to the surrounding components when opening the **LCD connector**.

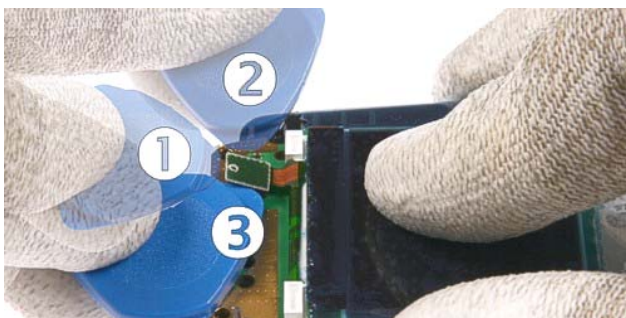

15.) Use the SRT-6 to open the **LCD connector** in the order shown. Take care to the flex foil of the **LCD Module**.



16.) Remove the **LCD Module**.



17.) Remove the **Light Guide Assy.**

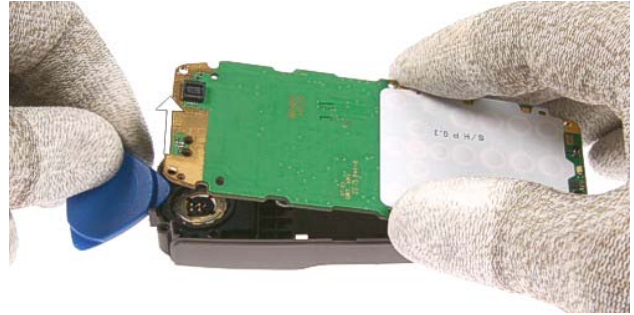

18.) Lift the **Engine Module** a bit with the SRT-6 and remove it from the **D-Cover Assy.**



19.) The **Antenna IHF Assy** drops out when turning the **D-Cover Assy.**

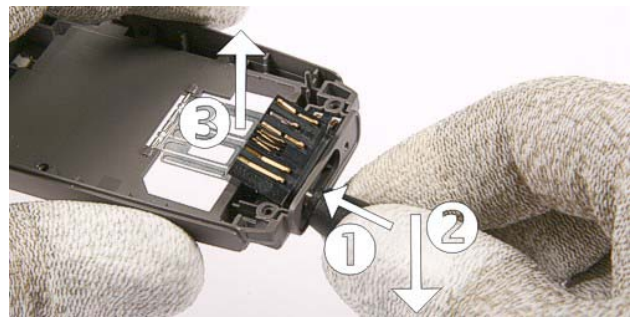



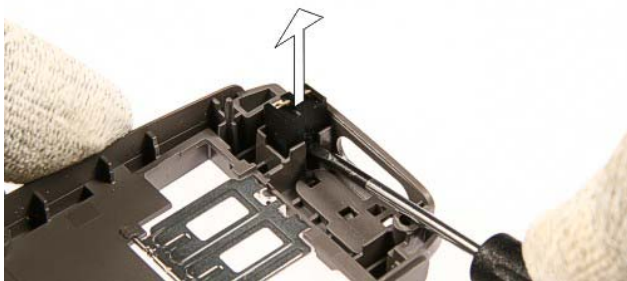





20.) Press out the **Easy Flash Connector** by using the DC-plug.



21.) Remove the **Microphone** with the slotted screwdriver.

## 10. LEGEND FOR QUICK TROUBLE SHOOTER

This legend is valid for all parts of the **Quick Trouble Shooter**

Follow the steps until the problem is solved. If this doesn't help, you are not authorized to go forward.	
	Only marked components ( e.g. I002  ) can be changed.
	The start point of repair activities regarding the appeared fault symptoms.
	Follow the arrows step by step
	Pads or contacts: Check optical and mechanical condition particularly regarding to corrosion. Clean if necessary.
	Measure component for electrical functionality and change, if needed. (Level 2 only)
	Pads or contacts: Check optical and mechanical condition particularly regarding to corrosion. Clean with ESD brush only, if necessary.
	No more actions possible send product to the appropriate service supplier with higher service level.

**11. QUICK TROUBLE SHOOTER PART 1**

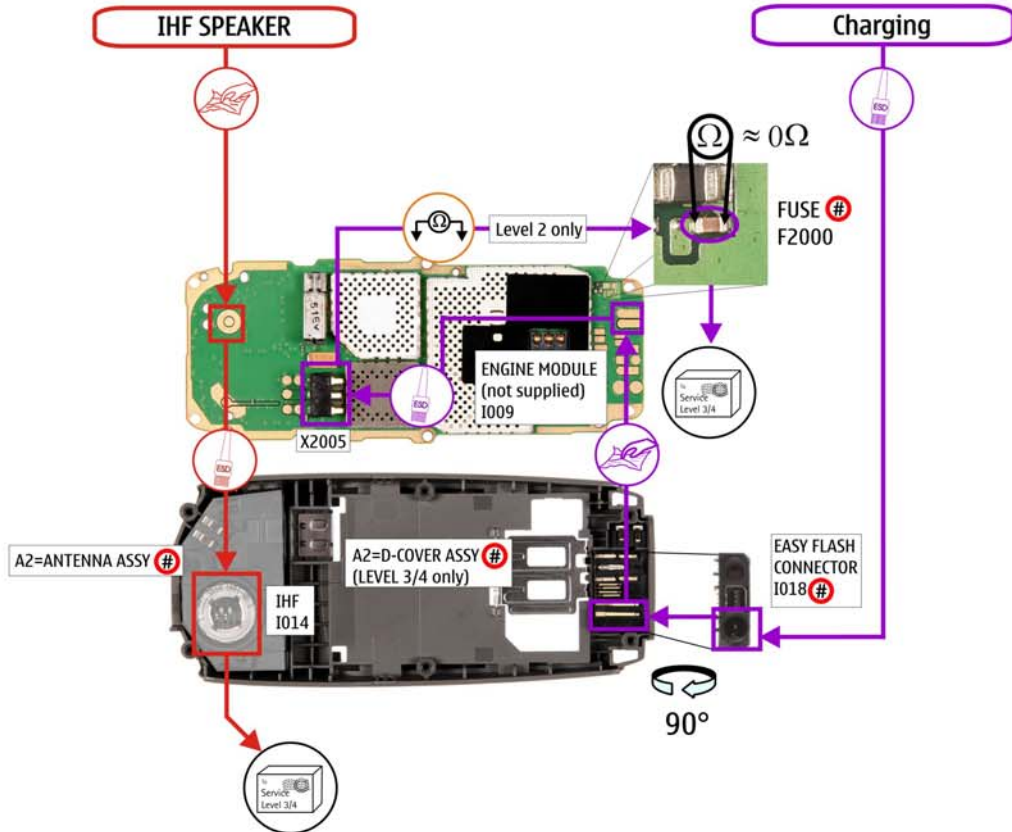
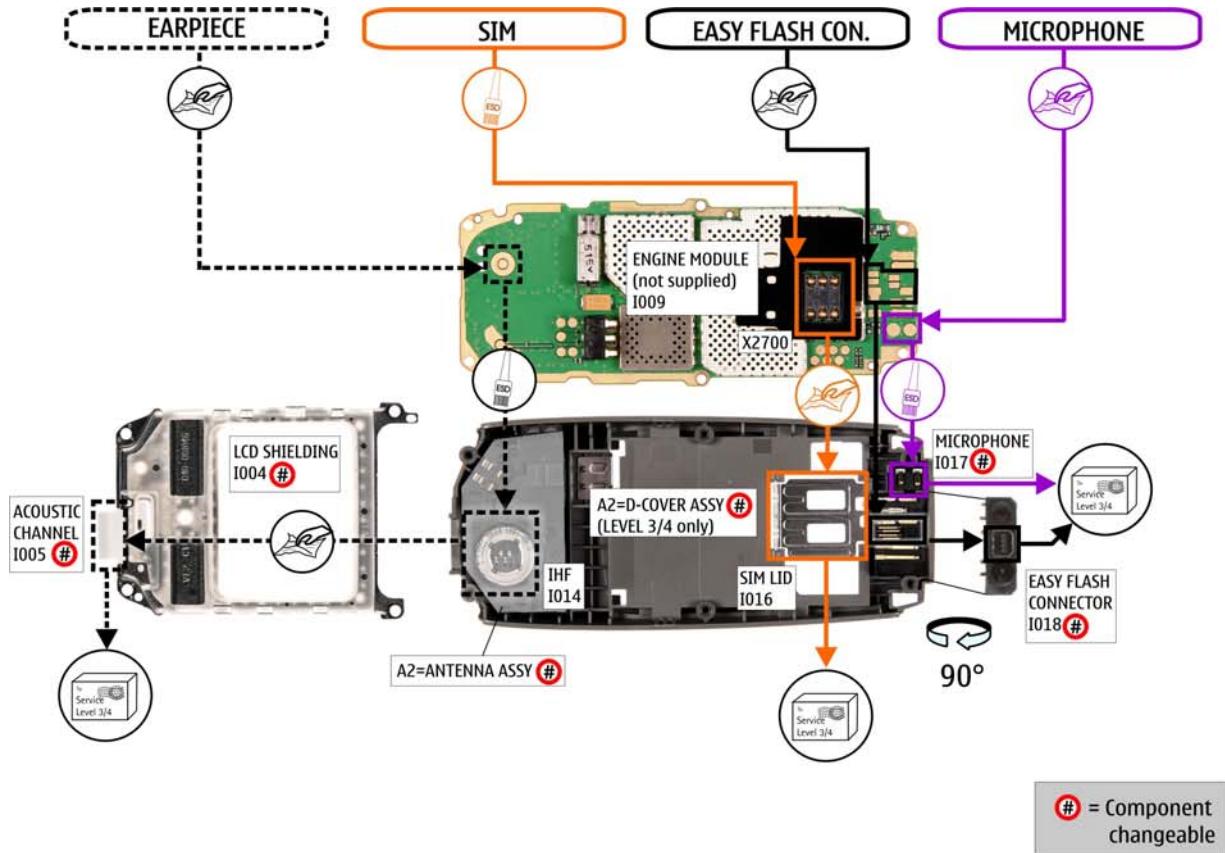



**12. QUICK TROUBLE SHOOTER PART 2**

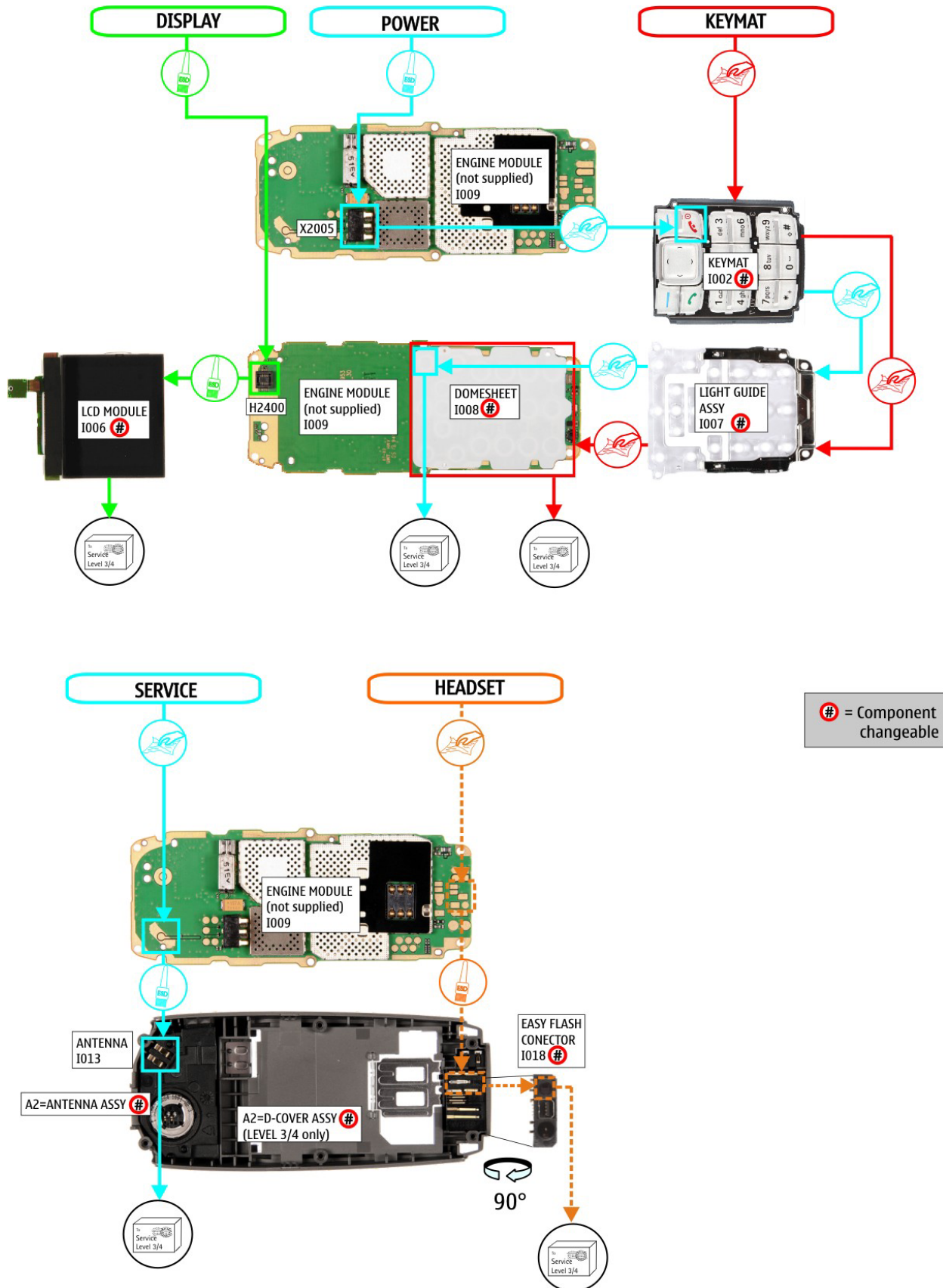

## 13. GONOGO TEST

After the optical check, a GoNoGo test has to be carried out if the unit has been unscrewed to guarantee the functionality of the phone.

**Please refer to the actual information on NOKIA Online. When using delivered tester support files, take care of the right setup according to the tester type and product type.  
Please refer to “Recommended Service Equipment” on NOKIA Online.**

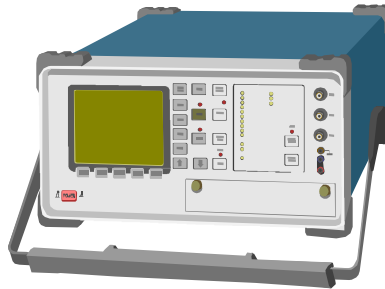

Mobile Phone Tester

## 14. BATTERY TEST

A battery tester lets you test the capacity of NOKIA batteries.

Please refer to the actual information on NOKIA Online.



<http://www.astratec.co.uk/>



<http://www.cadex.com/>

## 15. FORWARDING OF REPAIRS

When it is necessary to forward of repairs to appropriate service supplier with higher service level we recommend using the offered swap phone cartons as described in Spare Parts SB-004.



Always Protect the window with a protection film.



Put the unit under the stretch film.



Add repair documentation e.g. filled-in service note into the swap carton.



Fold the swap carton as shown in Spare Parts SB-004.



There are two different sizes of swap cartons for common mobile phones.

## 16. ESD PROTECTION REQUIREMENTS

Please refer to the NOKIA Online document [Service Supplier Requirements](#) in folder General instructions.

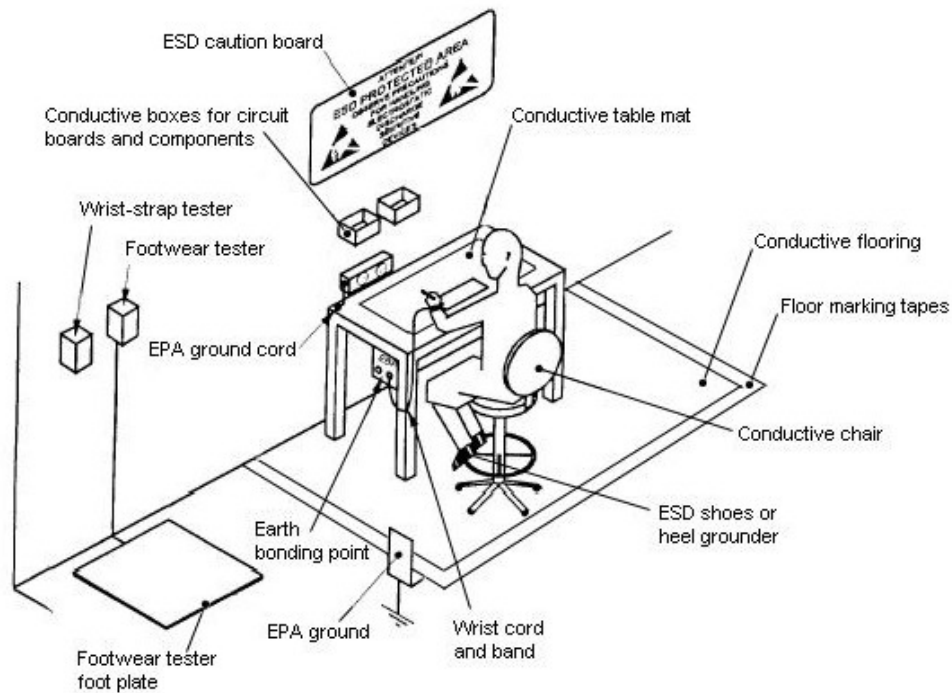

- USE** Conductive bags and boxes
- USE** ESD compatible service tools
- USE** Conductive wastebaskets
- USE** ESD gloves when handling PWBs/PCBs
- USE** Cleaning material without changing el. Characteristics
- USE** Grounded service equipment, i.e. soldering station
- USE** ESD clothes such as coat or frock

- NO** Smoking
- NO** Drinking
- NO** Eating
- NO** Dust
- NO** Useless Items
- NO** Normal pressured air for cleaning modules/displays